LOGICA

INDICE VISIVO

LINEAR SYSTEM

	Linear System 10		Streamlight System 16		Streamlight accessori 21
	Streamlight Incasso 22				

MAGNETIC SYSTEM

	Klik Klak 34		Binario Klik Klak e accessori 42		Klik Klak Mini 44
	Binario Klik Klak Mini e accessori 52		Klik Klak Micro 54		Binario Klik Klak Micro e accessori 60





























TRACK

	Fulgor 64		Bombo 78		Sun_111 84
	Unico Dicro 89		Unico AR111 89		Sospensioni Track 90
	Invisibile 94		Streamlight Track 96		Emergenza Track 105
	Tracks Tracks incasso + accessori 100-102				

DOWNLIGHTS

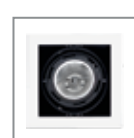
	Dot 108		Deep_EVO EXTR. 114		Deep_EVO LESS EXTR. 114
---	------------	---	-----------------------	---	----------------------------













DOWNLIGHTS

	Deep_EVO 126		Deep_EVO LESS 127		Deep_EVO GRANDE 128
	Deep_EVO LESS GRANDE 129		Deep_EVO_Q 130		Deep_EVO LESS_Q 130
	Deep_EVO_Q GRANDE 131		Deep_EVO STD 131		MODULI LED e Accessori 132-133
	Deep_EVO GU10 134		Deep_EVO AR111 GU10 136		Light_35 140
	Light_50 144		Light_111 150		Lumis_T 158
	Lumis_Q 159		Fulgor_IN 160		Bellatrix 162
	Punto Punto L 166		Occhio 171		Mini 172
	Zeus 175		Aqua_EVO COB 178		Aqua_EVO SMD 179
	Frame 182		Frame 111 183		Frameless 185
	Frameless 111 186		Wizard 188		

SUSPENSION LIGHTS

	A+B 194		Shanghai 198		Cyl Sosp 202
---	------------	---	-----------------	---	-----------------

CEILING LIGHTS

	A+B 206		Fulgor 210		Sun_111 212
	Unico Dicro 214		Klik Klak puntiforme 216		Lumis_T 222
	Lumis_Q 223		Cyl 224		Altair 226
	Box Dicro 234		Box 111 235		Container 237
	Container 111 238				









WALL LIGHTS

	Torcia_V 242		Torcia_O 248		Minima 254
	Essential 260		Su&Giù 264		Bloc_Evo 266
	Dumbo 268		Sun_111 212		Fulgor 210
	Unico Dicro 214		Altair 226		

PROFILES

	Wall 274		Onda 275		Line_EVO 276
---	-------------	---	-------------	---	-----------------

PROFILES

	Line DEEP 280		Line 281		Line_MINI 279
	Double 282		PR1 283		PR1_DEEP 283
	PR2 284		PR2_DEEP 284		PR3_EVO 285

RECHARGEABLE

	Twiggy_LESS 292		Diogene 298		Iota 304
	Zen 308		Caricatore multiplo 296-311		

OUTDOOR

	Slice 314		Titano EVO 316		Moonlight 322
	Fos 326		Combi_Evo 330		Dardo 332
	Skorpio 336				

DRIVER E ACCESSORI

	Driver e Accessori 340
---	---------------------------

Logica

Lighting Design

LOGICA è un brand di illuminazione che ricerca la semplicità e il minimalismo delle forme, eliminando tutto ciò che è superfluo. L'illuminazione diventa un mix equilibrato tra design senza tempo e funzionalità versatile, dove i prodotti sono pensati per adattarsi perfettamente a uffici, case e spazi espositivi. LOGICA si impegna nella ricerca della perfezione nei dettagli e nella selezione attenta dei materiali, offrendo un'estetica raffinata e materiali di alta qualità e garantendo un prodotto che va oltre le mode passeggere. Che si tratti di accentuare gli spazi o di illuminare in modo sottile, LOGICA offre soluzioni versatili per soddisfare le diverse esigenze.

LOGICA is a lighting brand that seeks simplicity and minimalism in its forms, eliminating anything superfluous. Lighting becomes a balanced blend of timeless design and versatile functionality, where products are designed to fit seamlessly into offices, homes, and display spaces. LOGICA is dedicated to pursuing perfection in details and carefully selecting materials, offering a refined aesthetic and high-quality materials. This ensures a product that goes beyond fleeting trends. Whether it's accentuating spaces or providing subtle illumination, LOGICA offers versatile solutions to meet diverse needs.



LOGICA

LINEAR
SYSTEM

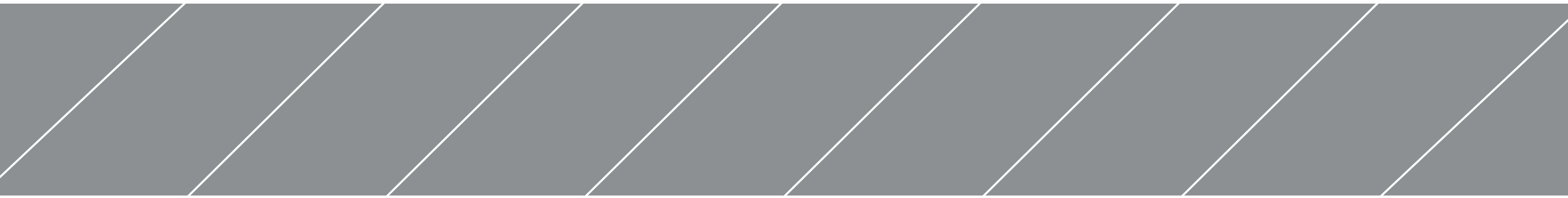

Linear System



Profilo LED integrato mono emissione in alluminio estruso verniciato
Ottiche integrate (prismatica e diffondente) antiabbagliamento
Driver DALI push integrato

*Integrated mono-emission LED profile in painted extruded aluminum
Integrated optics (prismatic and diffusing) to prevent glare
Integrated DALI push driver*



LINEAR SYSTEM DALI-PUSH



LED SAMSUNG
CRI >90
PF 0,95

CODE	FINISHING	WATT	LUMEN	WATT LIGHT SOURCE	LUMEN LIGHT SOURCE	BEAM	KELVIN	MODE	KG
42044	Bianco/white	32W	2270	28W	3320	70°	3000K	DALI-PUSH	3,50
42045	Bianco/white	32W	2280	28W	3370	70°	4000K	DALI-PUSH	3,50
42046	Nero/Black	32W	2270	28W	3320	70°	3000K	DALI-PUSH	3,50
42047	Nero/Black	32W	2280	28W	3370	70°	4000K	DALI-PUSH	3,50
42048	Bianco/white	47W	3320	42W	5000	70°	3000K	DALI-PUSH	4,90
42049	Bianco/white	47W	3390	42W	5500	70°	4000K	DALI-PUSH	4,90
42050	Nero/Black	47W	3320	42W	5000	70°	3000K	DALI-PUSH	4,90
42051	Nero/Black	47W	3390	42W	5500	70°	4000K	DALI-PUSH	4,90
42052	Bianco/white	64W	4470	57W	6772	70°	3000K	DALI-PUSH	6,20
42053	Bianco/white	64W	4530	57W	6800	70°	4000K	DALI-PUSH	6,20
42054	Nero/Black	64W	4470	57W	6772	70°	3000K	DALI-PUSH	6,20
42055	Nero/Black	64W	4530	57W	6800	70°	4000K	DALI-PUSH	6,20

INSTALLAZIONE APPLICATION

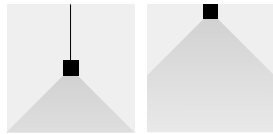

Sospensione/
Suspension

Soffitto/Ceiling

DISEGNI TECNICI TECHNICAL DRAWINGS

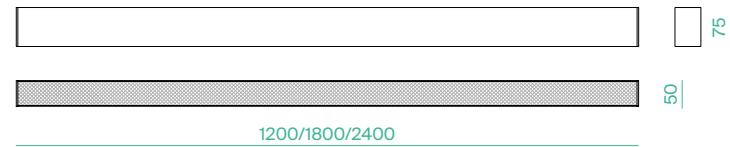

ACCESSORI ACCESSORIES



42056 - 42057

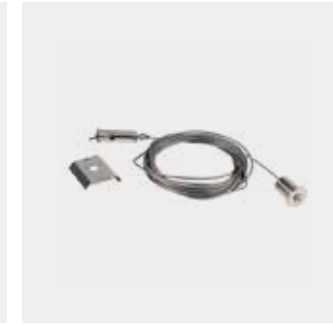

42058

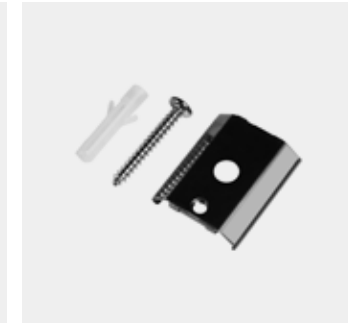

42059

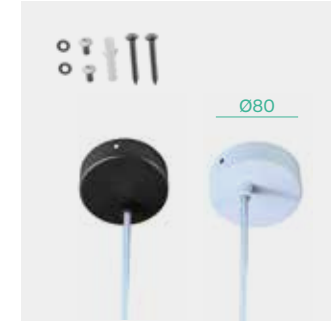

42060 - 42061



42062

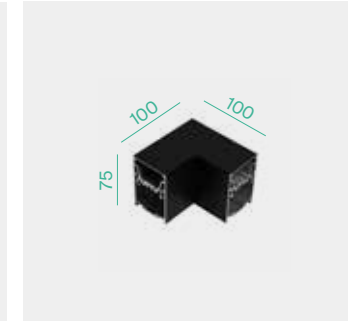

42064 - 42065

CODE	DESCRIPTION	FINISHING
42056	Testate (2 pz.)/End-Caps (2 pc.)	Bianco/White
42057	Testate (2 pz.)/End-Caps (2 pc.)	Nero/Black
42058	Sospensione acciaio 2 mt (2 pz.) / Steel cable 2 mt (2 pc.)	n/a
42059	Attacco a soffitto (2 pz.)/Ceiling bracket (2 pc.)	n/a
42060	Cavo elettrico e rosone ø80 mm 2 mt / Electric cable and canopy 80 mm 2 mt	Bianco/White
42061	Cavo elettrico e rosone ø80 mm 2 mt / Electric cable and canopy ø80 mm 2 mt	Nero/Black
42062	Congiunzione Lineare/Linear Connector	n/a
42064	Giunto "L"/"L"-Connector	Bianco/White
42065	Giunto "L"/"L"-Connector	Nero/Black

illuminazione funzionale

Functional lighting

Ideato per gli ambienti lavorativi, questo sistema di illuminazione in alluminio estruso offre una soluzione sofisticata e minimale per gli uffici moderni.

La combinazione dello schermo prismatico e del diffusore satinato assicura un comfort visivo ottimale, garantendo una distribuzione uniforme della luce. La sua elevata resa cromatica CRI>90 restituisce fedelmente i colori, creando un ambiente luminoso e accogliente.

Designed for professional environments, this extruded aluminum lighting system offers a sophisticated and minimal solution for modern offices.

The combination of the prismatic screen and satin diffuser ensures optimal visual comfort, guaranteeing even light distribution. Its high color rendering index (CRI>90) faithfully reproduces colors, creating a bright and welcoming environment.

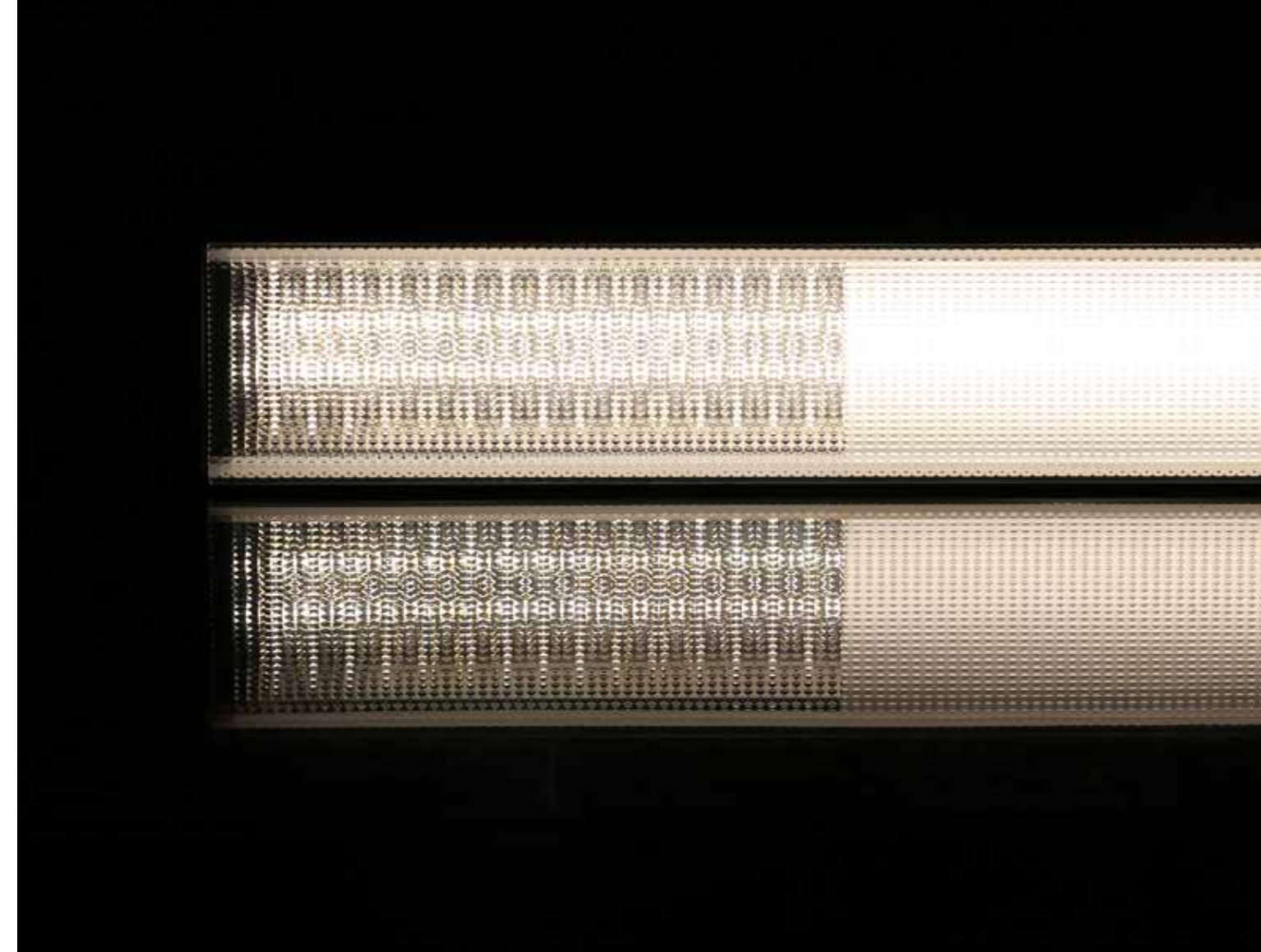

Grazie al sistema DALI Push, è possibile gestire il flusso luminoso con precisione, offrendo un controllo personalizzato dell'illuminazione.

Il pratico montaggio a sospensione aggiunge elemento di versatilità che lo rende estremamente versatile.

Thanks to the DALI Push system, precise management of the light flow is achievable, providing personalized lighting control.

The convenient suspension mounting adds a versatile element, making it extremely adaptable.

Possibilità di applicazione:
Variety of applications:

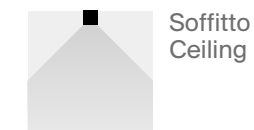
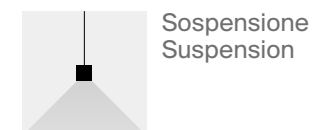

Streamlight System

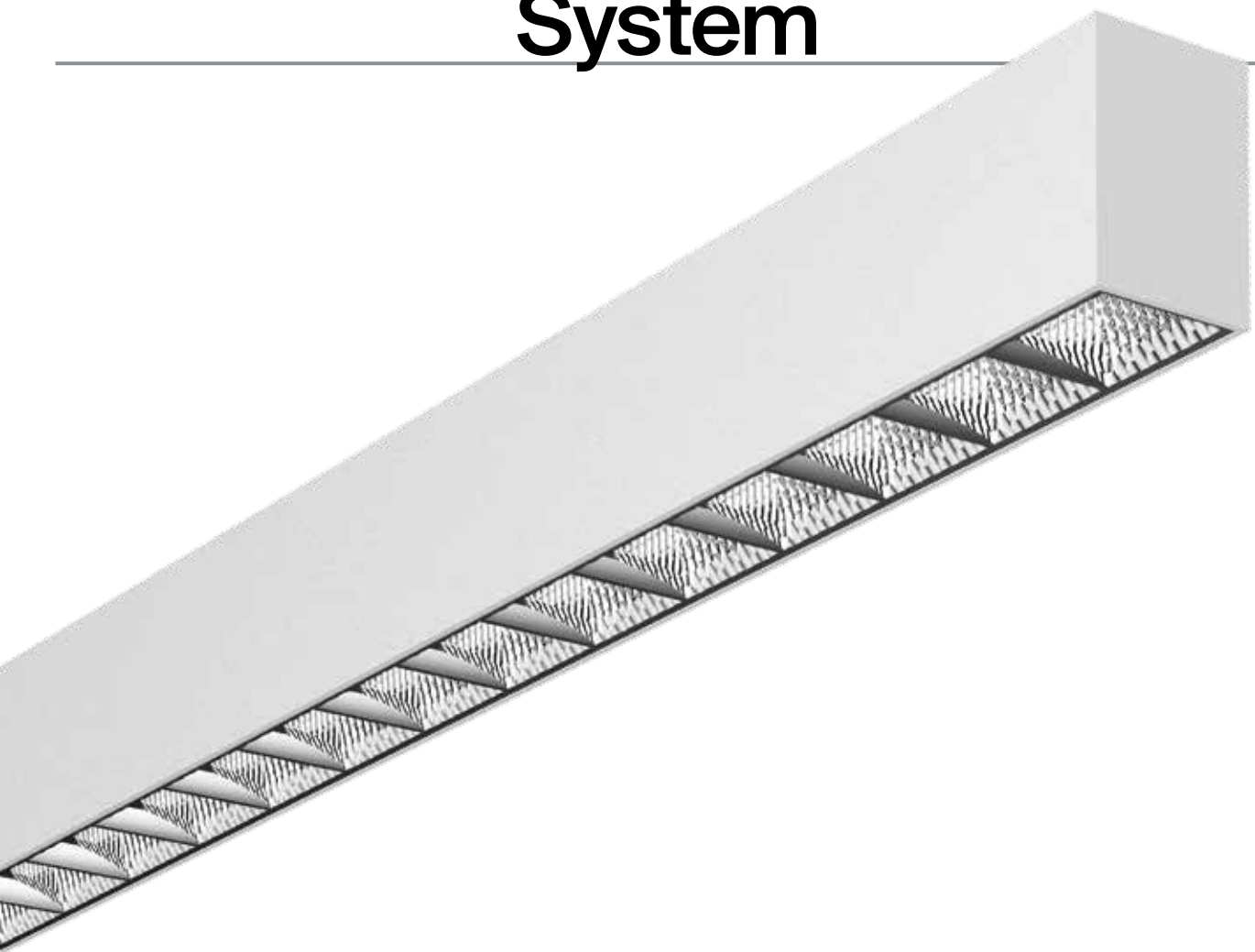

Profilo LED integrato bi-emissione in alluminio estruso
Ottiche anti-glare UGR<19 per luce diretta e schermo in PC per luce indiretta
Driver integrato. Versioni ON/OFF, 1-10V o Dalì

*Extruded aluminium profile equipped with integrated LED for direct and indirect lighting
Anti-glare UGR<19 optical reflectors for direct lighting and PC diffuser for indirect lighting
Integrated Driver. ON/OFF, 1-10V or DALI version*

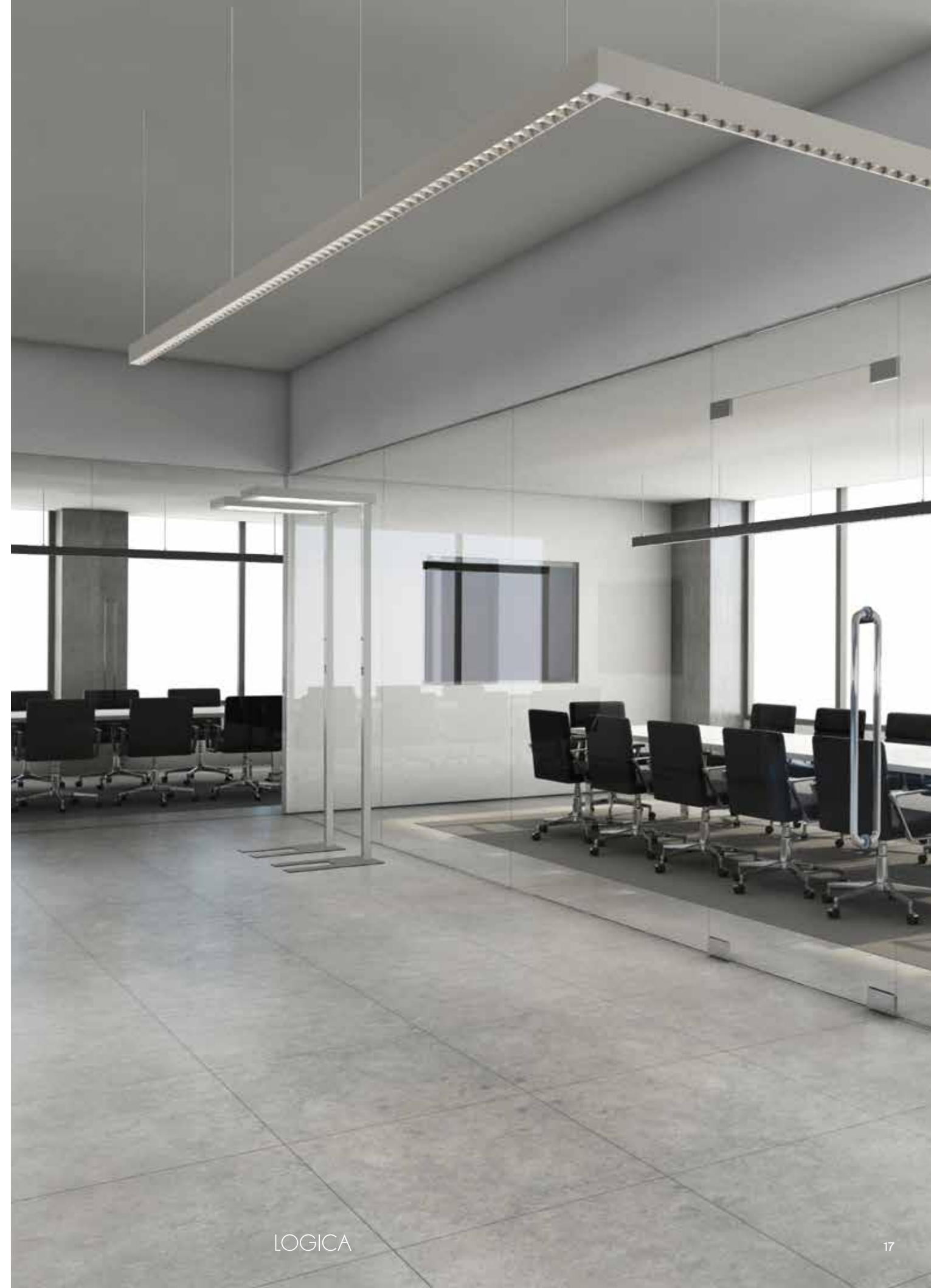

Comfort visivo *Visual comfort*

Il componente riflettente del sistema Streamlight_System è progettato appositamente per evitare fastidiosi riflessi. Quando combinato con l'opzione di illuminazione indiretta, contribuisce a ridurre l'affaticamento visivo, promuovendo un indispensabile benessere negli ambienti lavorativi.

The reflective component of the Streamlight_System is designed to avoid bothersome glares. When paired with the indirect lighting option, it helps reduce visual strain, fostering essential well-being in the workplace.



L90B10_42000hrs

STREAMLIGHT_SYSTEM offre flessibilità di installazione, consentendo sia il montaggio a sospensione che a soffitto. Grazie ai giunti integrati, può essere facilmente adattato e collegato in modo versatile, garantendo la sua adattabilità in diversi ambienti.

STREAMLIGHT_SYSTEM offers versatility in installation, allowing both suspension and surface mounting. Moreover, with integrated joints, it can be easily adapted and interconnected flexibly in various settings, ensuring its versatility across different environments.

Possibilità di applicazione:
Variety of applications:

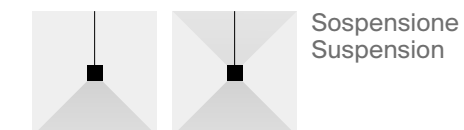
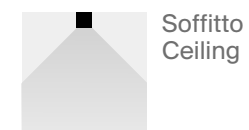

STREAMLIGHT SYSTEM

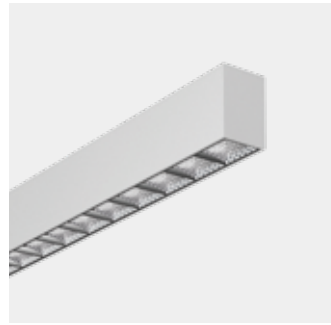

LED SAMSUNG
CRI >82
PF 0,9

CODE	FINISHING	WATT	LUMEN	WATT LIGHT SOURCE	LUMEN LIGHT SOURCE	BEAM	KELVIN	DRIVER	KG
42654	Bianco/ White	27W+3W	2700 +300	22.5W+2.5W	3375+375	85**85°	3000K	ON-OFF 36V-750mA	1,80
42655	Nero/Black	27W+3W	2700 +300	22.5W+2.5W	3375+375	85**85°	3000K	ON-OFF 36V-750mA	1,80
42656	Bianco/ White	27W+3W	2800 +400	22.5W+2.5W	3600+400	85**85°	4000K	ON-OFF 36V-750mA	1,80
42657	Nero/Black	27W+3W	2800 +400	22.5W+2.5W	3600+400	85**85°	4000K	ON-OFF 36V-750mA	1,80
42662	Bianco/ White	41W+4W	4300 +400	34.2W+3.8W	5310+590	85**85°	3000K	ON-OFF 36V-1250mA	3,50
42663	Nero/Black	41W+4W	4300 +400	34.2W+3.8W	5310+590	85**85°	3000K	ON-OFF 36V-1250mA	3,50
42664	Bianco/ White	41W+4W	4500 +500	34.2W+3.8W	5625+625	85**85°	4000K	ON-OFF 36V-1250mA	3,50
42665	Nero/Black	41W+4W	4500 +500	34.2W+3.8W	5625+625	85**85°	4000K	ON-OFF 36V-1250mA	3,50
42776	Bianco/ White	27W+3W	2700 +300	22.5W+2.5W	3375+375	85**85°	3000K	1-10V 36V-750mA	1,80
42777	Nero/Black	27W+3W	2700 +300	22.5W+2.5W	3375+375	85**85°	3000K	1-10V 36V-750mA	1,80
42778	Bianco/ White	27W+3W	2800 +400	22.5W+2.5W	3600+400	85**85°	4000K	1-10V 36V-750mA	1,80
42779	Nero/Black	27W+3W	2800 +400	22.5W+2.5W	3600+400	85**85°	4000K	1-10V 36V-750mA	1,80
42780	Bianco/ White	41W+4W	4300 +400	34.2W+3.8W	5310+590	85**85°	3000K	1-10V 36V-1250mA	3,50
42781	Nero/Black	41W+4W	4300 +400	34.2W+3.8W	5310+590	85**85°	3000K	1-10V 36V-1250mA	3,50
42782	Bianco/ White	41W+4W	4500 +500	34.2W+3.8W	5625+625	85**85°	4000K	1-10V 36V-1250mA	3,50
42783	Nero/Black	41W+4W	4500 +500	34.2W+3.8W	5625+625	85**85°	4000K	1-10V 36V-1250mA	3,50
42658	Bianco/ White	27W+3W	2700 +300	22.5W+2.5W	3375+375	85**85°	3000K	DALI-PUSH 36V-750mA	1,80
42659	Nero/Black	27W+3W	2700 +300	22.5W+2.5W	3375+375	85**85°	3000K	DALI-PUSH 36V-750mA	1,80
42660	Bianco/ White	27W+3W	2800 +400	22.5W+2.5W	3600+400	85**85°	4000K	DALI-PUSH 36V-750mA	1,80
42661	Nero/Black	27W+3W	2800 +400	22.5W+2.5W	3600+400	85**85°	4000K	DALI-PUSH 36V-750mA	1,80
42666	Bianco/ White	41W+4W	4300 +400	34.2W+3.8W	5310+590	85**85°	3000K	DALI-PUSH 36V-1250mA	3,50
42667	Nero/Black	41W+4W	4300 +400	34.2W+3.8W	5310+590	85**85°	3000K	DALI-PUSH 36V-1250mA	3,50
42668	Bianco/ White	41W+4W	4500 +500	34.2W+3.8W	5625+625	85**85°	4000K	DALI-PUSH 36V-1250mA	3,50
42669	Nero/Black	41W+4W	4500 +500	34.2W+3.8W	5625+625	85**85°	4000K	DALI-PUSH 36V-1250mA	3,50

INSTALLAZIONE APPLICATION

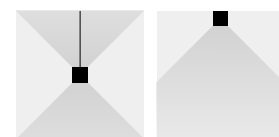

Sospensione/ Suspension
Soffitto/Ceiling

DISEGNI TECNICI TECHNICAL DRAWINGS

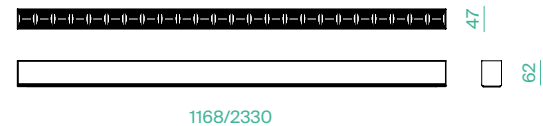

ACCESSORI ACCESSORIES



42672

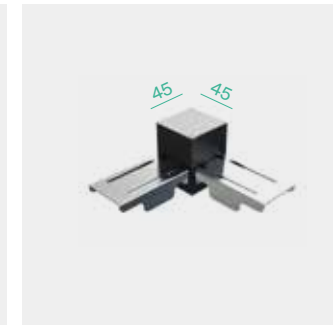

42673 - 42674

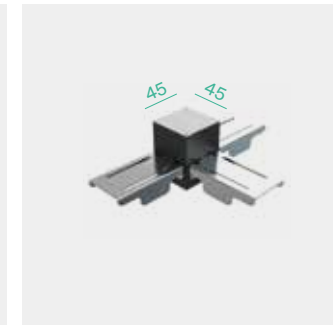

42677 - 42678



42675 - 42676

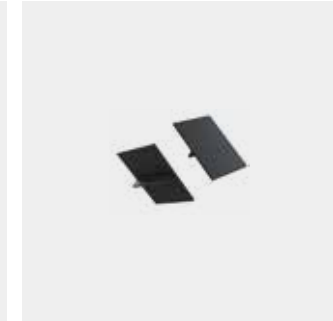

42679 - 42680



42681 - 42682 - 42685

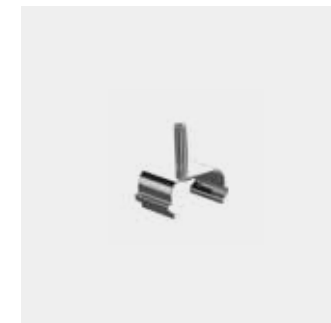

42728

CODE	DESCRIPTION	FINISHING
42672	Congiunzione Lineare / Linear Connector	Alluminio/Aluminium
42673	Giunto "L"/"L"-Connector	Nero / Black
42674	Giunto "L"/"L"-Connector	Bianco / White
42675	Giunto "X"/"X"-Connector	Nero / Black
42676	Giunto "X"/"X"-Connector	Bianco / White
42677	Giunto "T"/"T"-Connector	Nero / Black
42678	Giunto "T"/"T"-Connector	Bianco / White
42679	Testate (2 Pcs.)/End-Caps	Nero / Black
42680	Testate (2 Pcs.)/End-Caps	Bianco / White
42681	Sospensione acciaio 2 mt (1 pz) / Steel cable 2 mt (1 pc)	n/a
42682	Sospensione e rosone ø115mm 2 mt (1 pz) / Suspension and canopy ø115mm 2 mt (1 pc)	Nero/Black
42685	Sospensione e rosone ø115mm 2 mt (1 pz) / Suspension and canopy ø115mm 2 mt (1 pc)	Bianco / White
42728	Attacco a soffitto/Ceiling bracket	n/a

STREAMLIGHT INCASSO



LED SAMSUNG
CRI >82
PF 0,9

CODE	FINISHING	WATT	LUMEN	BEAM	KELVIN	KG
42730	Bianco/White	24W	2200	85°*85°	3000K	0,40
42731	Bianco/White	24W	2400	85°*85°	4000K	0,40

INSTALLAZIONE APPLICATION



Incasso/Recessed

DISEGNI TECNICI TECHNICAL DRAWINGS

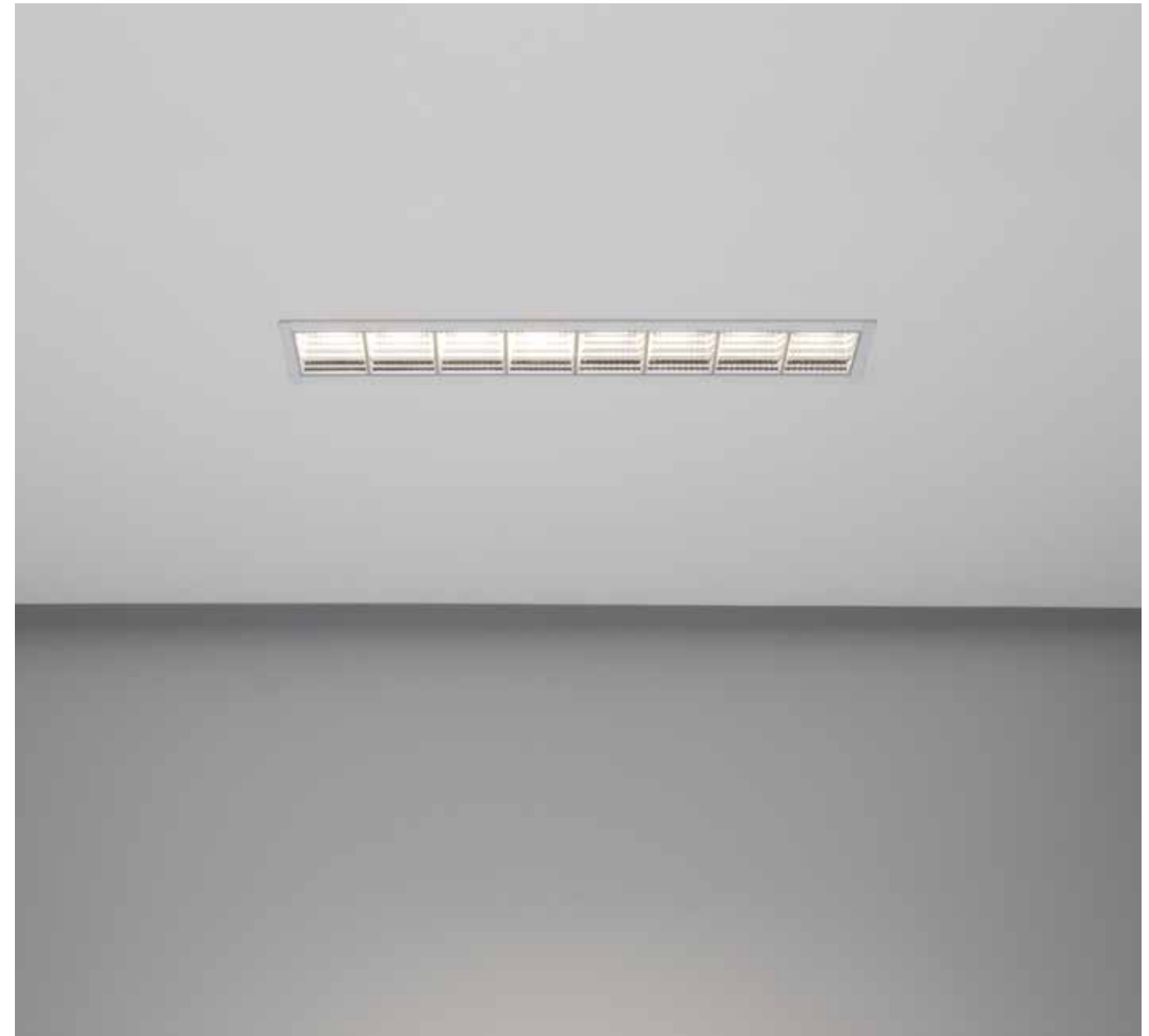

DRIVER

CODE	VOLT	CURRENT	PF	SIZE	MODE
42732	24-42V	650mA	0,9	120x45x30	ON-OFF

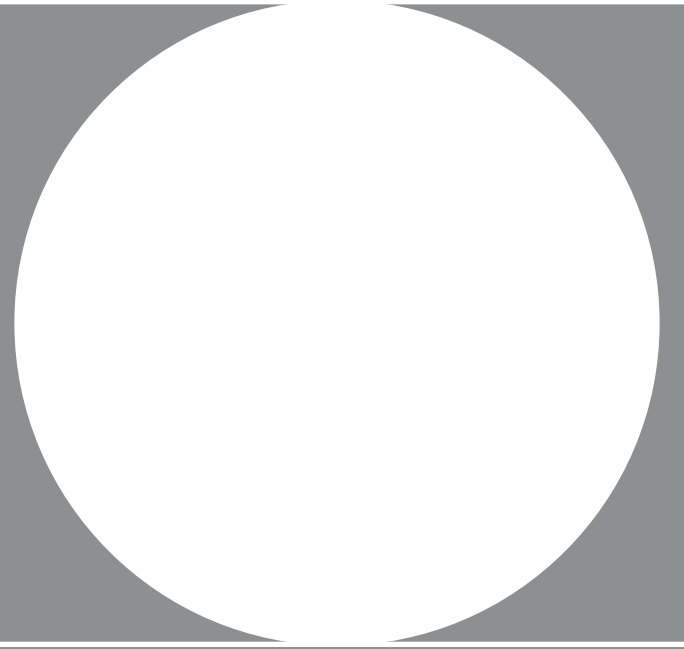
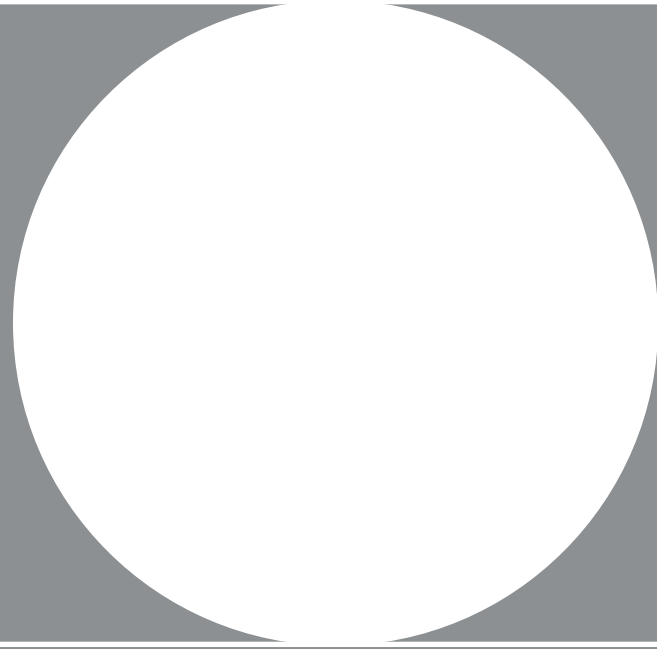
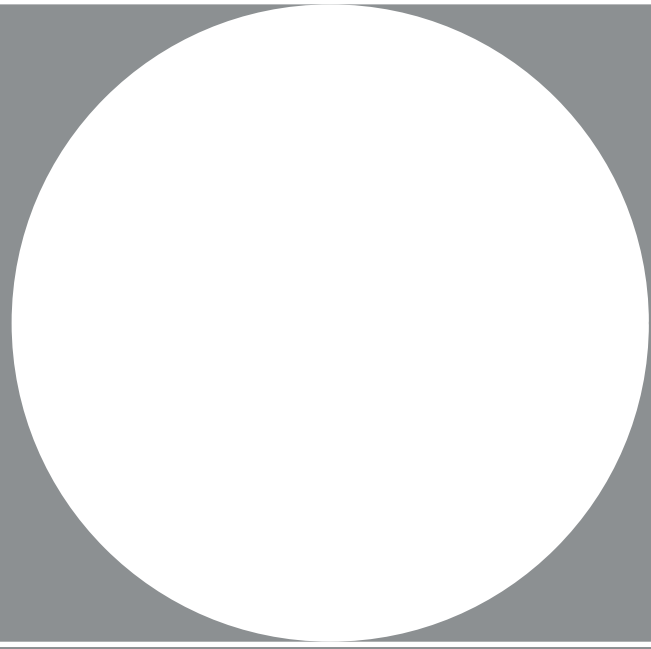
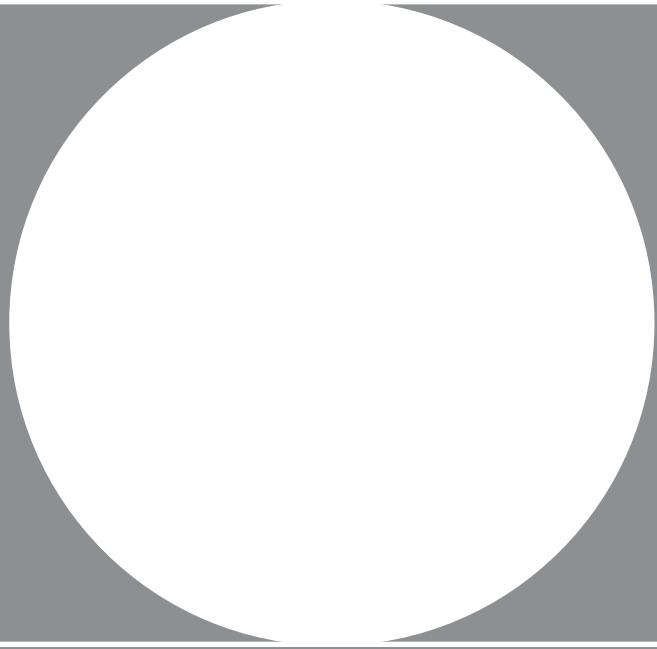

Klik Klak

KLIK_KLAK è un sistema completo declinabile in diverse tipologie di installazione: incasso a raso, a soffitto e a sospensione. I raccordi disponibili permettono di adattarlo a qualsiasi superficie e di introdurre dei cambi di piano: in questo modo si può inserire in maniera minimale negli spazi abitativi e commerciali rendendo la luce parte integrante del progetto di design.

KLIK_KLAK is a complete system suitable for recessed, ceiling-mounted or suspended installation. The many accessories available allow different solutions including multilevel combinations; it's the ideal choice for a discreet and minimal lighting solution both in residential and commercial areas making light an integral part of the whole project.

Possibilità di applicazione:
Variety of applications:

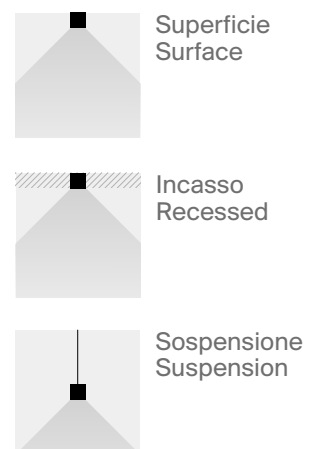

Dimensioni a confronto *Comparing dimensions*

KLIK_KLAK offre la possibilità di scegliere tra tre dimensioni differenti, trovando nelle varianti più ridotte una collocazione ancora più minimale nell'ambito della progettazione.

L'espansione della famiglia, STD, MINI e MICRO, riesce definitivamente ad incontrare le molteplici soluzioni illuminotecniche e d'arredamento.

KLIK_KLAK offers the possibility to choose from three different sizes, with the smaller variants allowing for an even more minimal placement within the scope of design.

The whole range, STD, MINI and MICRO, is definitely able to meet all lighting and interior design requirements.

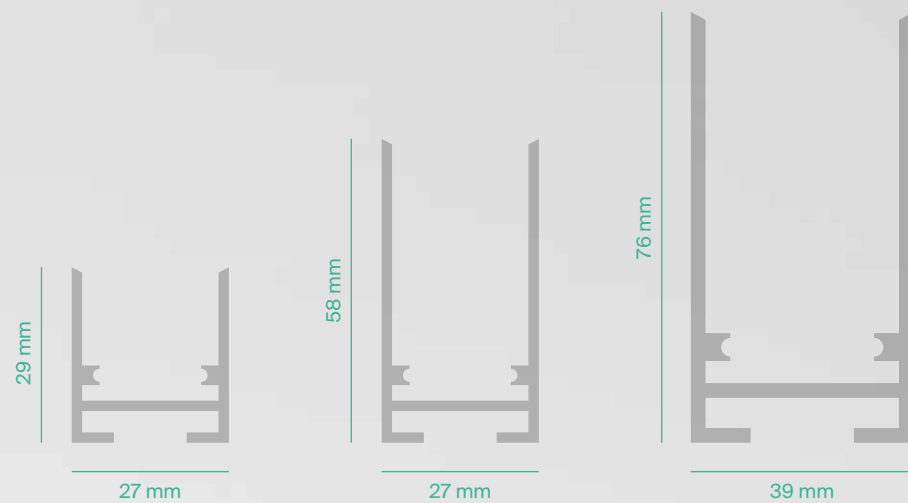



Attrazione magnetica

Magnetic attraction

Il sistema KLIK_KLAK sfrutta la potenza del magnete permanente NdFeB, il più potente del mondo. L'inserimento e lo spostamento dei corpi illuminanti con fissaggio magnetico risulta estremamente semplice e sicuro da maneggiare grazie all'alimentazione a 24V. L'ampliamento degli accessori completa un'offerta in grado di "giocare" con la luce.

Tutti gli apparecchi KLIK_KLAK sono dimmerabili 0/1-10V solamente utilizzando i drivers da noi forniti. Massimo wattaggio in serie 150W per una lunghezza massima di 10m.

KLIK_KLAK magnetic system counts on the power of NdFeb permanent magnet, the most powerful in the world. The installation and the eventual shifting of the fittings from one place to another on the low voltage 24V profile is extremely simple and safe. The wider range of accessories completes an offer which allows to "play" with light.

All KLIK_KLAK fittings are 0/1-10V dimmable only using the drivers provided by us. Max series wattage 150W for a maximum length of 10m.



Klik_Klak

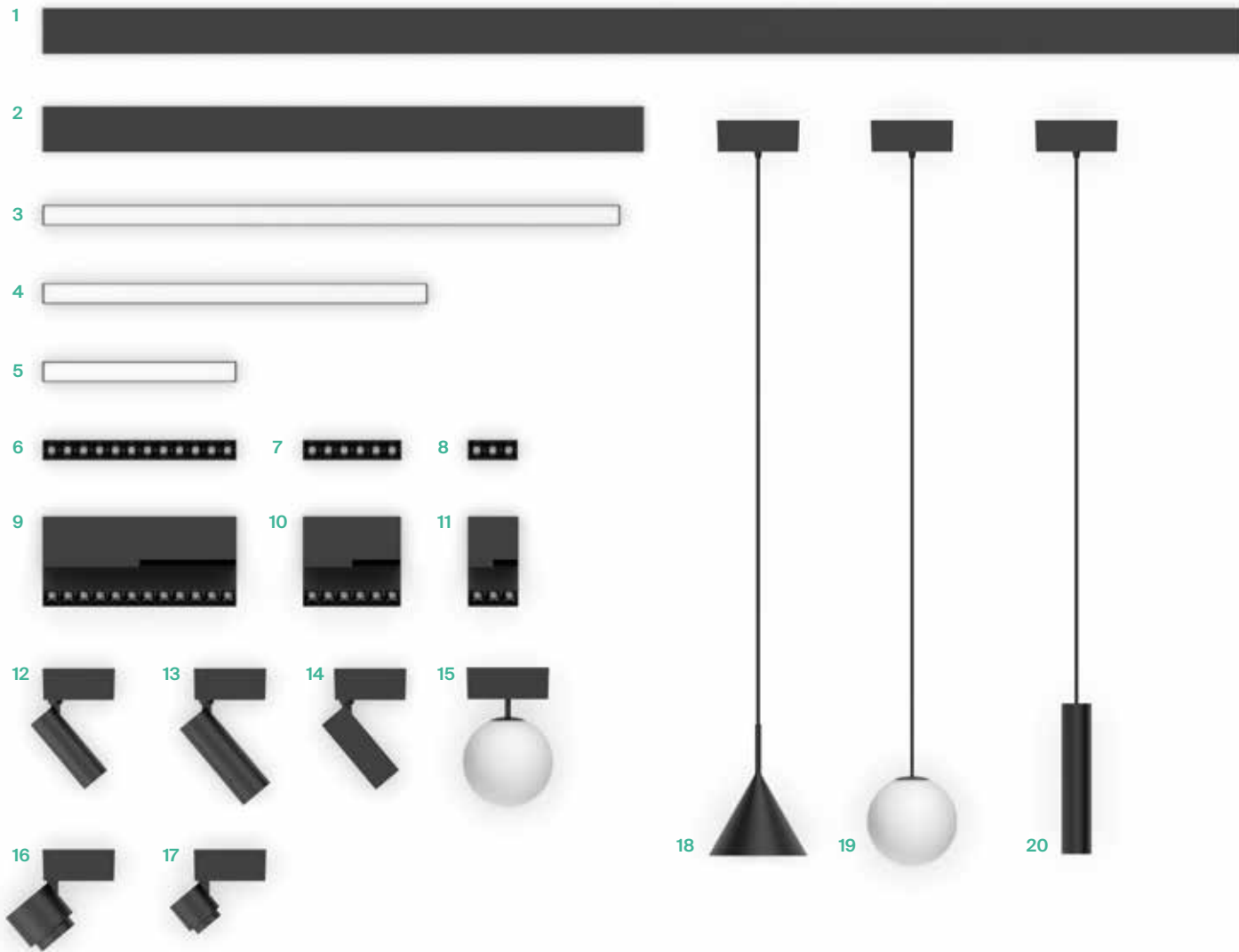

- 1 Binario 2mt
2m profile
- 2 Binario 1mt
1m profile
- 3 Luce diffusa 39W
Wide beam general lighting 39W
- 4 Luce diffusa 26W
Wide beam general lighting 26W
- 5 Luce diffusa 13W
Wide beam general lighting 13W
- 6 Luce puntiforme x12
Dots light x12
- 7 Luce puntiforme x6
Dots light x6
- 8 Luce puntiforme x3
Dots light x3
- 9 Luce puntiforme orientabile x12
Adjustable dots light x12
- 10 Luce puntiforme orientabile x6
Adjustable dots light x6
- 11 Luce puntiforme orientabile x3
Adjustable dots light x3
- 12 Proiettore 10W
Spotlight 10W
- 13 Proiettore 20W
Spotlight 20W
- 14 Proiettore Q 10W
Spotlight Q 10W
- 15 Globo
Globe
- 16 Proiettore 15W
Spotlight 15W
- 17 Proiettore 8W
Spotlight 8W
- 18 Sospensione bell
Suspension bell
- 19 Sospensione globo
Suspension globe
- 20 Sospensione cilindro
Suspension cylinder

KLIK_KLAK PROIETTORE

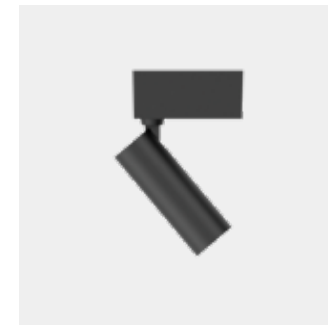

LED CREE
CRI >90
PF >0,7
SDCM <3

CODE	FINISHING	WATT	LUMEN	WATT LIGHT SOURCE	LUMEN LIGHT SOURCE	BEAM	KELVIN	KG
41111	Nero/Black	10W	749	8W	900	36°	3000K	0,35
41112	Bianco/White	10W	749	8W	900	36°	3000K	0,35
41179	Nero/Black	10W	870	8W	1100	36°	4000K	0,35
41192	Bianco/White	10W	870	8W	1100	36°	4000K	0,35
41772	Nero/Black	20W	1450	16W	1870	36°	3000K	0,78
41773	Bianco/White	20W	1450	16W	1870	36°	3000K	0,78

INSTALLAZIONE
APPLICATION

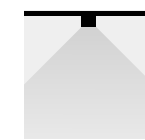

Binario magnetico/
Magnetic track

DISEGNI TECNICI
TECHNICAL DRAWINGS

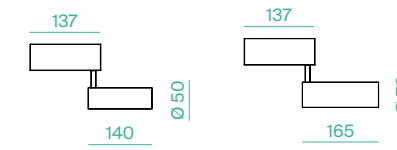

41111 41179 41772
41112 41192 41773

REGOLAZIONI
ADJUSTABILITY



KLIK_KLAK PROIETTORE

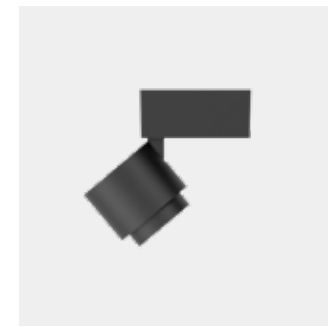

LED CREE
CRI >90
PF >0,7
SDCM <3

CODE	FINISHING	WATT	LUMEN	WATT LIGHT SOURCE	LUMEN LIGHT SOURCE	BEAM	KELVIN	KG
41176	Nero/Black	8W	404	6W	755	36°	3000K	0,42
41175	Bianco/White	8W	404	6W	755	36°	3000K	0,42
41178	Nero/Black	15W	904	12W	1395	36°	3000K	0,57
41177	Bianco/White	15W	904	12W	1395	36°	3000K	0,57
41214	Nero/Black	8W	483	6W	816	36°	4000K	0,42
41213	Bianco/White	8W	483	6W	816	36°	4000K	0,42
41216	Nero/Black	15W	957	12W	1477	36°	4000K	0,57
41215	Bianco/White	15W	957	12W	1477	36°	4000K	0,57

INSTALLAZIONE
APPLICATION



Binario magnetico/
Magnetic track

DISEGNI TECNICI
TECHNICAL DRAWINGS

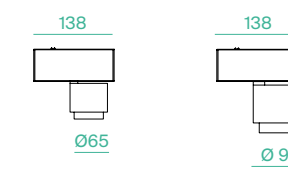

41175 41213 41177 41215
41176 41214 41178 41216

REGOLAZIONI
ADJUSTABILITY



KLIK_KLAK PROIETTORE Q

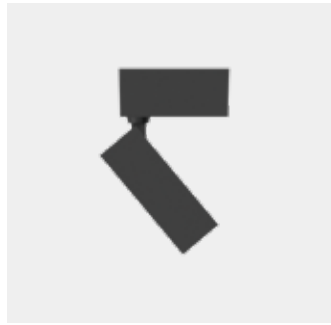

LED CREE
CRI >90
PF >0,5
SDCM <3

CODE	FINISHING	WATT	LUMEN	WATT LIGHT SOURCE	LUMEN LIGHT SOURCE	BEAM	KELVIN	KG
41770	Nero/Black	10W	749	8W	900	36°	3000K	0,52
41771	Bianco/White	10W	749	8W	900	36°	3000K	0,52

INSTALLAZIONE APPLICATION

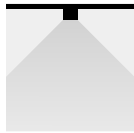

Binario magnetico/
Magnetic track

DISEGNI TECNICI TECHNICAL DRAWINGS

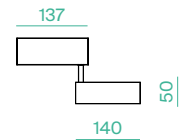

REGOLAZIONI ADJUSTABILITY



KLIK_KLAK GLOBO

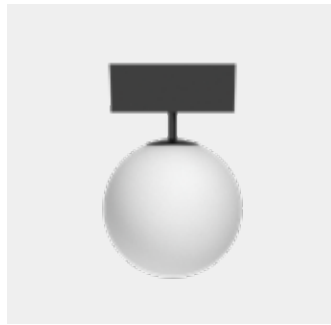

LED CREE
CRI >90
PF >0,5
SDCM <3

CODE	FINISHING	WATT	LUMEN	WATT LIGHT SOURCE	LUMEN LIGHT SOURCE	BEAM	KELVIN	KG
41778	Nero/Black	10W	680	8W	1105	DIFF.	3000K	0,46
41779	Bianco/White	10W	680	8W	1105	DIFF.	3000K	0,46

INSTALLAZIONE APPLICATION

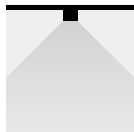

Binario magnetico/
Magnetic track

DISEGNI TECNICI TECHNICAL DRAWINGS

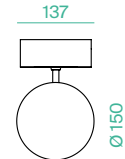

KLIK_KLAK PUNTIFORME

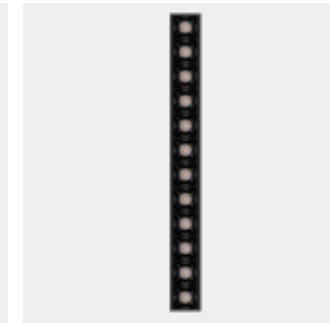
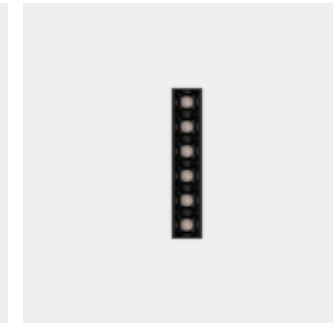
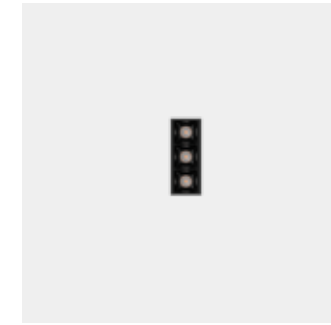

LED CREE
CRI >90
PF >0,7
SDCM <3

CODE	FINISHING	WATT	LUMEN	WATT LIGHT SOURCE	LUMEN LIGHT SOURCE	BEAM	KELVIN	KG
41119	Nero/Black	4W	375	3W	429	34°	3000K	0,16
41122	Bianco/White	4W	375	3W	429	34°	3000K	0,16
41120	Nero/Black	8W	788	6W	819	34°	3000K	0,28
41123	Bianco/White	8W	788	6W	819	34°	3000K	0,28
41121	Nero/Black	16W	1519	12W	1647	34°	3000K	0,40
41124	Bianco/White	16W	1519	12W	1647	34°	3000K	0,40
41199	Nero/Black	4W	381	3W	438	34°	4000K	0,16
41202	Bianco/White	4W	381	3W	438	34°	4000K	0,16
41200	Nero/Black	8W	741	6W	832	34°	4000K	0,28
41203	Bianco/White	8W	741	6W	832	34°	4000K	0,28
41201	Nero/Black	16W	1530	12W	1729	34°	4000K	0,40
41204	Bianco/White	16W	1530	12W	1729	34°	4000K	0,40

INSTALLAZIONE APPLICATION



Binario magnetico/
Magnetic track

DISEGNI TECNICI TECHNICAL DRAWINGS

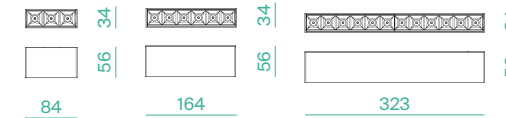

41199 41200 41201
41202 41203 41204
41119 41120 41121
41122 41123 41124



KLIK_KLAK PUNIFORME ORIENTABILE



LED CREE
CRI >90
PF >0,7
SDCM <3

CODE	FINISHING	WATT	LUMEN	WATT LIGHT SOURCE	LUMEN LIGHT SOURCE	BEAM	KELVIN	KG
41125	Nero/Black	4W	375	3W	429	34°	3000K	0,49
41128	Bianco/White	4W	375	3W	429	34°	3000K	0,49
41126	Nero/Black	8W	788	6W	819	34°	3000K	0,88
41129	Bianco/White	8W	788	6W	819	34°	3000K	0,88
41127	Nero/Black	16W	1519	12W	1647	34°	3000K	1,30
41130	Bianco/White	16W	1519	12W	1647	34°	3000K	1,30
41205	Nero/Black	4W	381	3W	438	34°	4000K	0,49
41208	Bianco/White	4W	381	3W	438	34°	4000K	0,49
41206	Nero/Black	8W	741	6W	832	34°	4000K	0,88
41209	Bianco/White	8W	741	6W	832	34°	4000K	0,88
41207	Nero/Black	16W	1530	12W	1729	34°	4000K	1,30
41210	Bianco/White	16W	1530	12W	1729	34°	4000K	1,30

INSTALLAZIONE APPLICATION

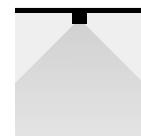

Binario magnetico/
Magnetic track

DISEGNI TECNICI TECHNICAL DRAWINGS

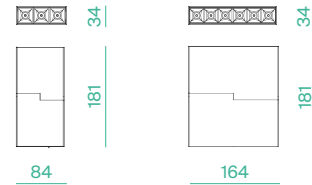

41205 41206
41208 41209
41125 41126
41128 41129

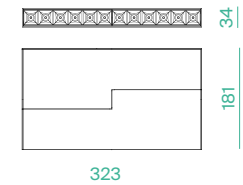

41207
41210
41127
41130

REGOLAZIONI ADJUSTABILITY



±90°



KLIK_KLAK LUCÈ DIFFUSA

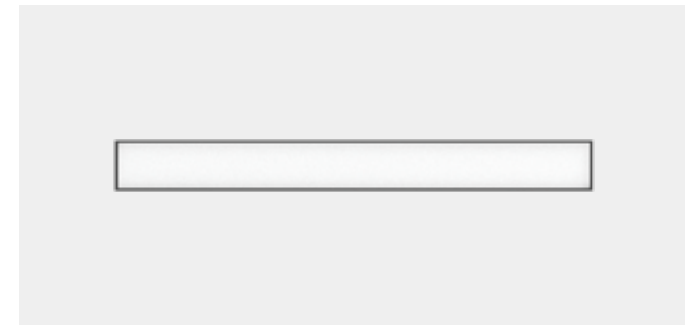

LED CREE
CRI >90
PF >0,7
SDCM <3

CODE	FINISHING	WATT	LUMEN	WATT LIGHT SOURCE	LUMEN LIGHT SOURCE	BEAM	KELVIN	KG
41113	Nero/Black	13W	962	10W	1560	105°	3000K	0,48
41116	Bianco/White	13W	962	10W	1560	105°	3000K	0,48
41114	Nero/Black	26W	1858	20W	3052	105°	3000K	0,96
41117	Bianco/White	26W	1858	20W	3052	105°	3000K	0,96
41115	Nero/Black	39W	2729	30W	4368	105°	3000K	1,44
41118	Bianco/White	39W	2729	30W	4368	105°	3000K	1,44
41193	Nero/Black	13W	965	10W	1638	105°	4000K	0,48
41196	Bianco/White	13W	965	10W	1638	105°	4000K	0,48
41194	Nero/Black	26W	2030	20W	3113	105°	4000K	0,96
41197	Bianco/White	26W	2030	20W	3113	105°	4000K	0,96
41195	Nero/Black	39W	2945	30W	4543	105°	4000K	1,44
41198	Bianco/White	39W	2945	30W	4543	105°	4000K	1,44

INSTALLAZIONE APPLICATION

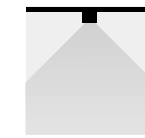

Binario magnetico/
Magnetic track

DISEGNI TECNICI TECHNICAL DRAWINGS



41113 41193 41114 41194
41116 41196 41117 41197



41115 41195
41118 41198



KLIK_KLAK SOSPENSIONE



LED CREE
CRI >90
PF >0,5
SDCM <3

CODE	FINISHING	WATT	LUMEN	WATT LIGHT SOURCE	LUMEN LIGHT SOURCE	BEAM	KELVIN	KG
41174	Nero/Black	10W	749	8W	900	36°	3000K	0,56
41173	Bianco/White	10W	749	8W	900	36°	3000K	0,56
41212	Nero/Black	10W	870	8W	1100	36°	4000K	0,56
41211	Bianco/White	10W	870	8W	1100	36°	4000K	0,56

INSTALLAZIONE
APPLICATION

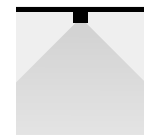

Binario magnetico/
Magnetic track

DISEGNI TECNICI
TECHNICAL DRAWINGS

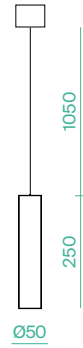

KLIK_KLAK SOSPENSIONE BELL



LED CREE
CRI >90
PF >0,5
SDCM <3

CODE	FINISHING	WATT	LUMEN	WATT LIGHT SOURCE	LUMEN LIGHT SOURCE	BEAM	KELVIN	KG
41776	Nero/Black	10W	415,8	8W	900	65°	3000K	0,44
41777	Bianco/White	10W	571,9	8W	900	65°	3000K	0,44

INSTALLAZIONE
APPLICATION

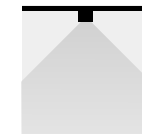

Binario magnetico/
Magnetic track

DISEGNI TECNICI
TECHNICAL DRAWINGS

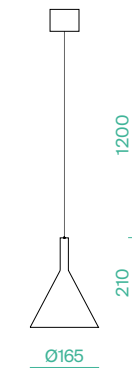

KLIK_KLAK SOSPENSIONE GLOBO



LED CREE
CRI >90
PF 0,5
SDCM <3

CODE	FINISHING	WATT	LUMEN	WATT LIGHT SOURCE	LUMEN LIGHT SOURCE	BEAM	KELVIN	KG
41774	Nero/Black	10W	680	8W	1105	DIFF.	3000K	0,50
41775	Bianco/White	10W	680	8W	1105	DIFF.	3000K	0,50

INSTALLAZIONE
APPLICATION

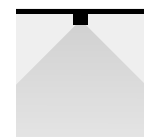

Binario magnetico/
Magnetic track

DISEGNI TECNICI
TECHNICAL DRAWINGS



KLIK_KLAK
ACCESSORI
ACCESSORIES

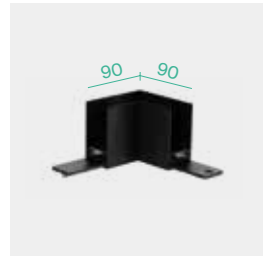

41136 - 41137

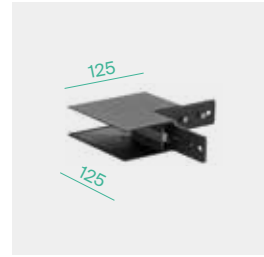

41138 - 41139

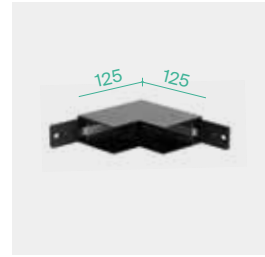

41140 - 41141

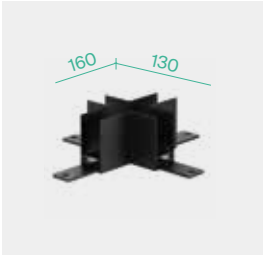

41257 - 41258

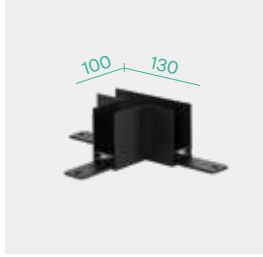

41259 - 41260



41142 - 41143

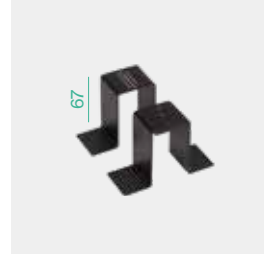

41131

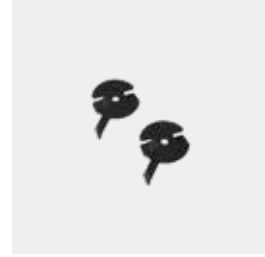

41222 - 41223



41132/A - 41133/A



41134 - 41135



41240 - 41241



42787 - 42784 - 42788 - 42785



42789 - 42786

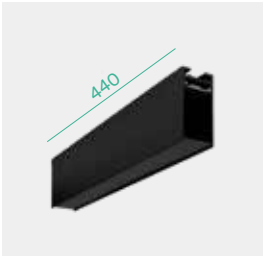

42811 - 42808 - 42812 - 42809



42813 - 42810

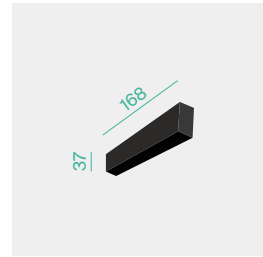

41782 - 41783

CODE	FINISHING	DESCRIPTION	KG
41109	Nero / Black	Struttura 1mt in alluminio estruso con testate / 1mt extruded aluminium profile with end-caps	1,50
41110	Bianco / White	Struttura 1mt in alluminio estruso con testate / 1mt extruded aluminium profile with end-caps	1,50
41144	Nero / Black	Struttura 2mt in alluminio estruso con testate / 2mt extruded aluminium profile with end-caps	3,00
41145	Bianco / White	Struttura 2mt in alluminio estruso con testate / 2mt extruded aluminium profile with end-caps	3,00
41146	Nero / Black	Copertura per rasatura 1 mt / 1 mt mask for plasterboard thinning	
41136	Nero / Black	Angolo 90° e accessori / 90° corner with accessories	
41137	Bianco / White	Angolo 90° e accessori / 90° corner with accessories	
41138	Nero / Black	Angolo 90° esterno e accessori/ Outer 90° corner with accessories	
41139	Bianco / White	Angolo 90° esterno e accessori/ Outer 90° corner with accessories	
41140	Nero / Black	Angolo 90° interno e accessori/ Inner 90° corner with accessories	
41141	Bianco / White	Angolo 90° interno e accessori/ Inner 90° corner with accessories	

KLIK_KLAK
ACCESSORI
ACCESSORIES

CODE	FINISHING	DESCRIPTION	KG
41142	Nero / Black	Congiunzione elettrica con spinotti/ Linear 65mm electric connection with relative 3-pins connector	
41143	Bianco / White	Congiunzione elettrica con spinotti/ Linear 65mm electric connection with relative 3-pins connector	
41131	Nero / Black	Kit staffe incasso (2 pz) / Brackets for recessed installation (2 pcs)	
41222	Nero / Black	Staffe attacco soffitto kit 2pz /Brackets for ceiling installation 2 pcs	
41223	Bianco / White	Staffe attacco soffitto kit 2pz /Brackets for ceiling installation 2 pcs	
41132	Acciaio/Steel	Sospensione 2mt (1 pz) / Suspension 2mt (1 pc)	
41132/A	Nero / Black	Sospensione con cavo alimentazione 2mt (1 pz) / Suspension 2mt with electrical wire (1 pc)	
41133/A	Bianco / White	Sospensione con cavo alimentazione 2mt (1 pz) / Suspension 2mt with electrical wire (1 pc)	
41134	Nero / Black	Staffa connessione (1 pz) /Linear connection plate (1 pc)	
41135	Bianco / White	Staffa connessione (1 pz) /Linear connection plate (1 pc)	
41258	Nero / Black	Giunto a "X"/"X" connector	
41257	Bianco / White	Giunto a "X"/"X" connector	
41260	Nero / Black	Giunto a "T"/"T" connector	
41259	Bianco / White	Giunto a "T"/"T" connector	
41241	Nero / Black	Testata per alimentazione 24V/Front feed 24V	
41240	Bianco / White	Testata per alimentazione 24V/Front feed 24V	
41782	Nero / Black	Ponte di giunzione elettrica 168mm H.37mm/Electric bridge connector 168mm H.37mm	
41783	Bianco / White	Ponte di giunzione elettrica 168mm H.37mm/Electric bridge connector 168mm H.37mm	
42787	Nero / Black	Testata c/ driver 75W 230V dimm./Front feed w/ driver 75W 230V dimm.	0,70
42784	Bianco / White	Testata c/ driver 75W 230V dimm./Front feed w/ driver 75W 230V dimm.	0,70
42788	Nero / Black	Testata c/ driver 100W 230V dimm./Front feed w/ driver 100W 230V dimm.	0,70
42785	Bianco / White	Testata c/ driver 100W 230V dimm./Front feed w/ driver 100W 230V dimm.	0,70
42789	Nero / Black	Testata c/ driver 150W 230V dimm./Front feed w/ driver 150W 230V dimm.	0,80
42786	Bianco / White	Testata c/ driver 150W 230V dimm./Front feed w/ driver 150W 230V dimm.	0,80
42811	Nero / Black	Centrale c/ driver 75W 230V dimm./Central feed w/ driver 75W 230V dimm.	0,72
42808	Bianco / White	Centrale c/ driver 75W 230V dimm./Central feed w/ driver 75W 230V dimm.	0,72
42812	Nero / Black	Centrale c/ driver 100W 230V dimm./Central feed w/ driver 100W 230V dimm.	0,72
42809	Bianco / White	Centrale c/ driver 100W 230V dimm./Central feed w/ driver 100W 230V dimm.	0,72
42813	Nero / Black	Centrale c/ driver 150W 230V dimm./Central feed w/ driver 150W 230V dimm.	0,82
42810	Bianco / White	Centrale c/ driver 150W 230V dimm./Central feed w/ driver 150W 230V dimm.	0,82

DRIVER

CODE	WATT	VOLT	DESCRIPTION	MODE	SIZE
22015	50W	24V DC	Driver MW	ON-OFF	99x82x30mm
22031	60W	24V DC	Driver EAGLERISE TRP	ON-OFF	187x45x31mm
22032	75W	24V DC	Driver EAGLERISE TRP	ON-OFF	187x45x31mm
22016	100W	24V DC	Driver MW	ON-OFF	129x97x30mm
22033	120W	24V DC	Driver EAGLERISE TRP	ON-OFF	268x45x31mm
22034	150W	24V DC	Driver EAGLERISE TRP	ON-OFF	268x45x31mm
22025	150W	24V DC	Driver MW	ON-OFF	160x95x30mm
22017	200W	24V DC	Driver MW	ON-OFF	215x115x30mm
41217	75W	24V DC	Driver dimmerabile LTECH	0-10V	294x43x30mm
41218	100W	24V DC	Driver dimmerabile LTECH	0-10V	240x70x36mm
41219	150W	24V DC	Driver dimmerabile LTECH	0-10V	354x43x30mm
11044	75W	24V DC	Driver LTECH	DALI	290x45x30mm
11045	150W	24V DC	Driver LTECH	DALI	290x45x30mm
11043	240W	24V DC	Driver LTECH	DALI	380x50x30mm

Klik_Klak Mini

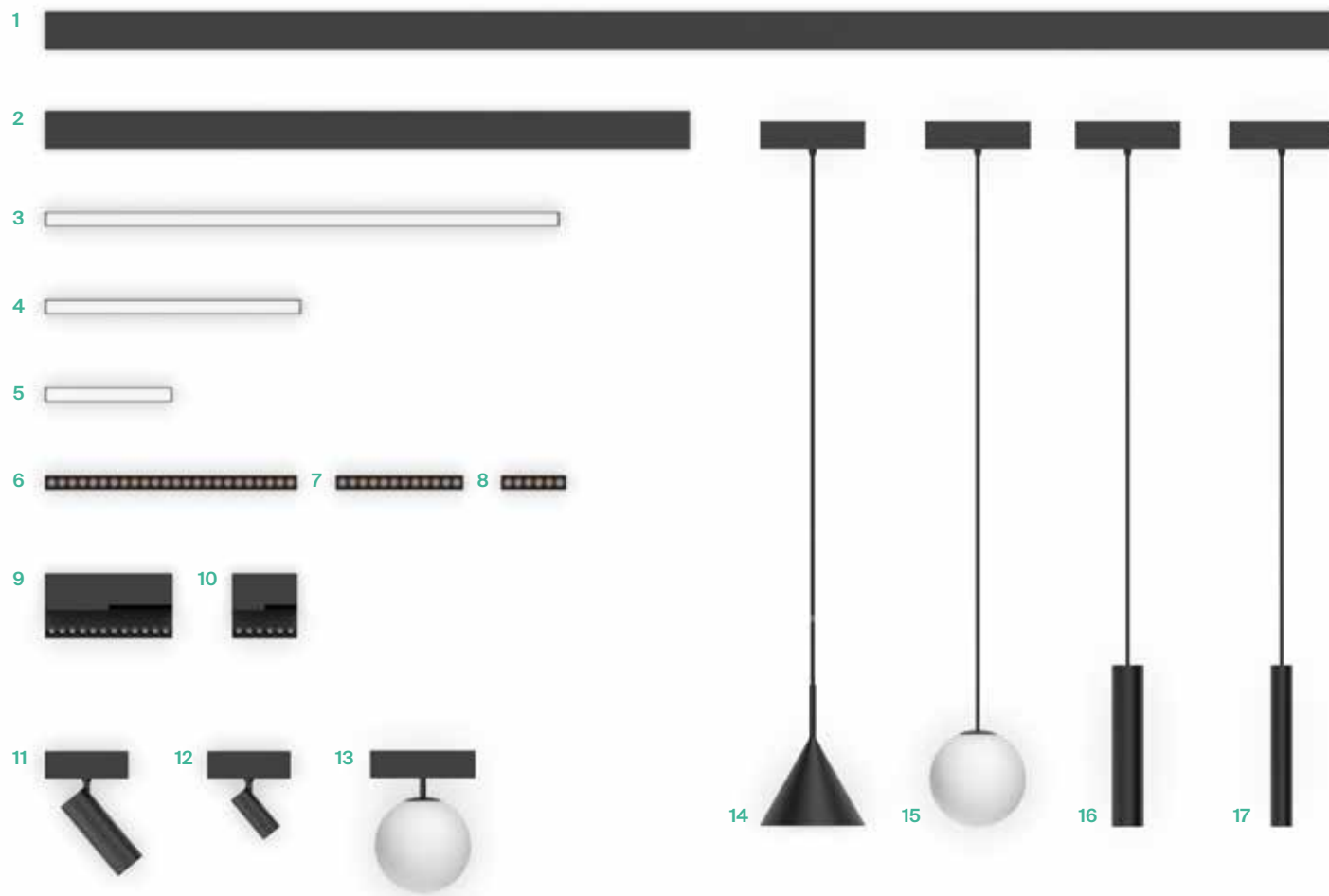

- 1 Binario 2mt
2m profile
- 2 Binario 1mt
1m profile
- 3 Luce diffusa 30W
Wide beam general lighting 30W
- 4 Luce diffusa 15W
Wide beam general lighting 15W
- 5 Luce diffusa 8W
Wide beam general lighting 8W
- 6 Luce puntiforme x24
Dots light x24
- 7 Luce puntiforme x12
Dots light x12
- 8 Luce puntiforme x6
Dots light x6
- 9 Luce puntiforme orientabile x12
Adjustable dots light x12
- 10 Luce puntiforme orientabile x6
Adjustable dots light x6
- 11 Proiettore 10W
Spotlight 10W
- 12 Proiettore 6W
Spotlight 6W
- 13 Globo
Globe
- 14 Sospensione bell
Suspension bell
- 15 Sospensione globo
Suspension globe
- 16 Sospensione cilindro 10W
Suspension cylinder 10W
- 17 Sospensione cilindro 6W
Suspension cylinder 6W

KLICK_KLAK MINI PROIETTORE

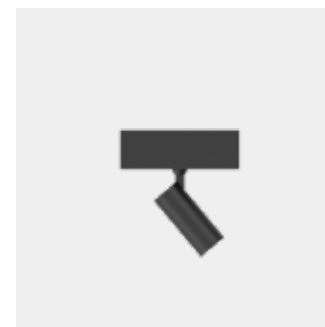

LED CREE
CRI >90
PF >0,5
SDCM <3

CODE	FINISHING	WATT	LUMEN	WATT LIGHT SOURCE	LUMEN LIGHT SOURCE	BEAM	KELVIN	KG
41733	Nero/Black	6W	423	5W	630	30°	3000K	0,26
41734	Bianco/White	6W	423	5W	630	30°	3000K	0,26

INSTALLAZIONE
APPLICATION

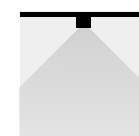

Binario magnetico/
Magnetic track

DISEGNI TECNICI
TECHNICAL DRAWINGS

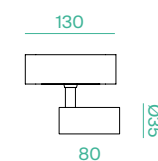

REGOLAZIONI
ADJUSTABILITY



KLICK_KLAK MINI PROIETTORE

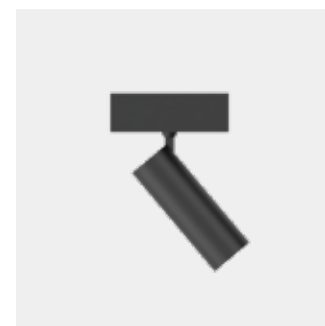

LED CREE
CRI >90
PF >0,5
SDCM <3

CODE	FINISHING	WATT	LUMEN	WATT LIGHT SOURCE	LUMEN LIGHT SOURCE	BEAM	KELVIN	KG
41735	Nero/Black	10W	749	8W	900	36°	3000K	0,35
41736	Bianco/White	10W	749	8W	900	36°	3000K	0,35

INSTALLAZIONE
APPLICATION

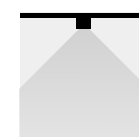

Binario magnetico/
Magnetic track

DISEGNI TECNICI
TECHNICAL DRAWINGS

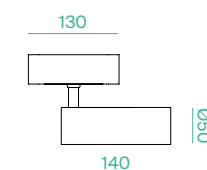

REGOLAZIONI
ADJUSTABILITY



KLIK_KLAK MINI GLOBO

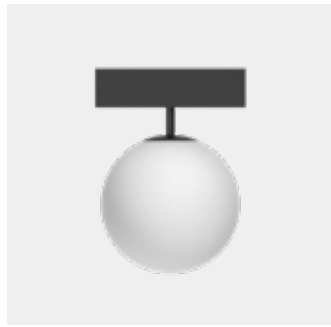

LED CREE
CRI >90
PF >0,5
SDCM <3

CODE	FINISHING	WATT	LUMEN	WATT LIGHT SOURCE	LUMEN LIGHT SOURCE	BEAM	KELVIN	KG
41745	Nero/Black	10W	680	8W	1105	DIFF.	3000K	0,46
41746	Bianco/White	10W	680	8W	1105	DIFF.	3000K	0,46

INSTALLAZIONE APPLICATION

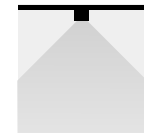

Binario magnetico/
Magnetic track

DISEGNI TECNICI TECHNICAL DRAWINGS

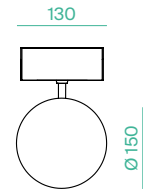

KLIK_KLAK MINI PUNTIFORME



LED CREE
CRI >90
PF >0,7
SDCM <3

CODE	FINISHING	WATT	LUMEN	WATT LIGHT SOURCE	LUMEN LIGHT SOURCE	BEAM	KELVIN	KG
41717	Nero/Black	6W	509	5W	693	30°	3000K	0,12
41718	Bianco/White	6W	509	5W	693	30°	3000K	0,12
41719	Nero/Black	12W	1011	10W	1410	30°	3000K	0,18
41720	Bianco/White	12W	1011	10W	1410	30°	3000K	0,18
41721	Nero/Black	24W	2041	20W	2750	30°	3000K	0,36
41722	Bianco/White	24W	2041	20W	2750	30°	3000K	0,36

INSTALLAZIONE APPLICATION

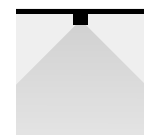

Binario magnetico/
Magnetic track

DISEGNI TECNICI TECHNICAL DRAWINGS

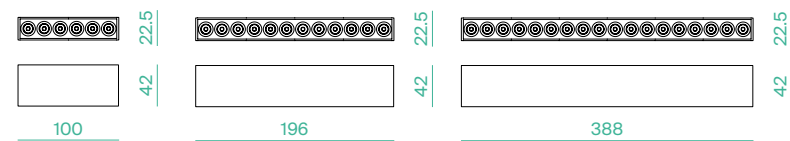

41717
41718

41719
41720

41721
41722



KLIK_KLAK MINI PUNTIFORME ORIENTABILE

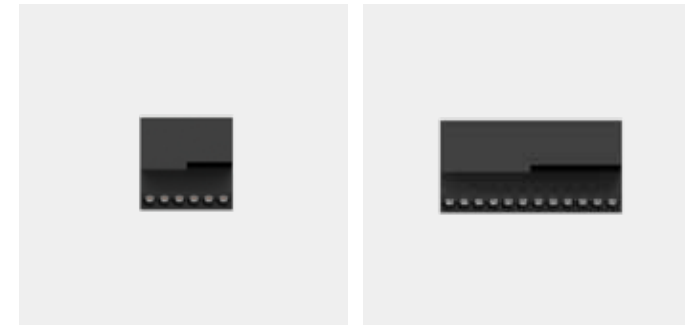

LED CREE
CRI >90
PF >0,7
SDCM <3

CODE	FINISHING	WATT	LUMEN	WATT LIGHT SOURCE	LUMEN LIGHT SOURCE	BEAM	KELVIN	KG
41729	Nero/Black	8W	681	6W	819	30°	3000K	0,24
41730	Bianco/White	8W	681	6W	819	30°	3000K	0,24
41731	Nero/Black	16W	1198	12W	1647	30°	3000K	0,48
41732	Bianco/White	16W	1198	12W	1647	30°	3000K	0,48

INSTALLAZIONE APPLICATION

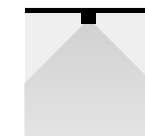

Binario magnetico/
Magnetic track

DISEGNI TECNICI TECHNICAL DRAWINGS

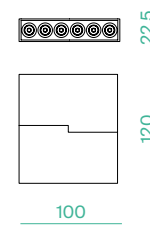

41729
41730

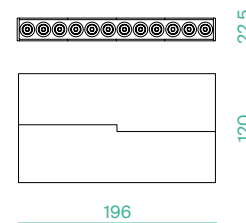

41731
41732

REGOLAZIONI ADJUSTABILITY



KLIK_KLAK MINI LUCÉ DIFFUSA

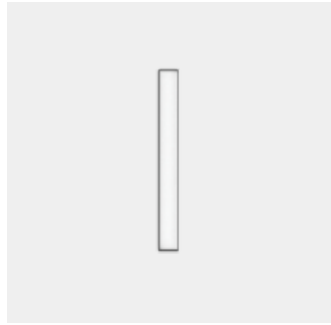

LED CREE
CRI >90
PF >0,7
SDCM <3

CODE	FINISHING	WATT	LUMEN	WATT LIGHT SOURCE	LUMEN LIGHT SOURCE	BEAM	KELVIN	KG
41723	Nero/Black	8W	605	6W	950	105°	3000K	0,19
41724	Bianco/White	8W	605	6W	950	105°	3000K	0,19
41725	Nero/Black	15W	1013	12W	1900	105°	3000K	0,32
41726	Bianco/White	15W	1013	12W	1900	105°	3000K	0,32
41727	Nero/Black	30W	1970	23W	3420	105°	3000K	0,66
41728	Bianco/White	30W	1970	23W	3420	105°	3000K	0,66

INSTALLAZIONE APPLICATION

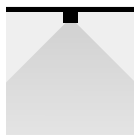

Binario magnetico/
Magnetic track

DISEGNI TECNICI TECHNICAL DRAWINGS

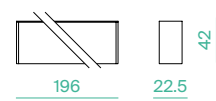

41723
41724



41725
41726

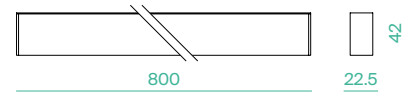

41727
41728



KLIK_KLAK MINI SOSPENSIONE

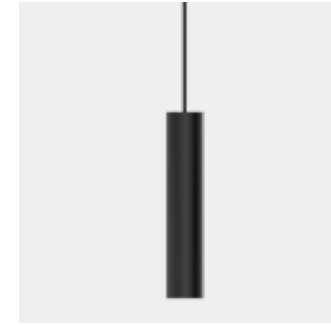

LED CREE
CRI >90
PF >0,5
SDCM <3

CODE	FINISHING	WATT	LUMEN	WATT LIGHT SOURCE	LUMEN LIGHT SOURCE	BEAM	KELVIN	KG
41739	Nero/Black	6W	423	5W	630	30°	3000K	0,48
41740	Bianco/White	6W	423	5W	630	30°	3000K	0,48
41737	Nero/Black	10W	749	8W	900	36°	3000K	0,56
41738	Bianco/White	10W	749	8W	900	36°	3000K	0,56

INSTALLAZIONE APPLICATION

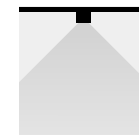

Binario magnetico/
Magnetic track

DISEGNI TECNICI TECHNICAL DRAWINGS

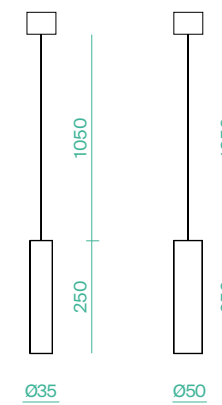

41739
41740

41737
41738



KLIK_KLAK MINI
SOSPENSIONE
GLOBO



LED CREE
CRI >90
PF >0,5
SDCM <3

CODE	FINISHING	WATT	LUMEN	WATT LIGHT SOURCE	LUMEN LIGHT SOURCE	BEAM	KELVIN	KG
41741	Nero/Black	10W	680	8W	1105	DIFF.	3000K	0,50
41742	Bianco/White	10W	680	8W	1105	DIFF.	3000K	0,50

INSTALLAZIONE
APPLICATION

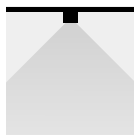

Binario magnetico/
Magnetic track

DISEGNI TECNICI
TECHNICAL DRAWINGS



KLIK_KLAK MINI
SOSPENSIONE
BELL



LED CREE
CRI >90
PF >0,5
SDCM <3

CODE	FINISHING	WATT	LUMEN	WATT LIGHT SOURCE	LUMEN LIGHT SOURCE	BEAM	KELVIN	KG
41743	Nero/Black	10W	415	8W	900	65°	3000K	0,44
41744	Bianco/White	10W	571	8W	900	65°	3000K	0,44

INSTALLAZIONE
APPLICATION



Binario magnetico/
Magnetic track

DISEGNI TECNICI
TECHNICAL DRAWINGS

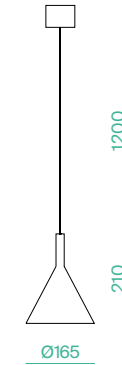

KLIK_KLAK MINI ACCESSORI ACCESSORIES

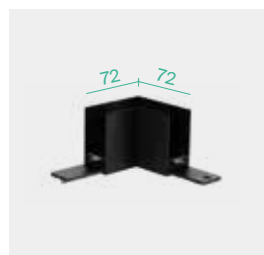

41747 - 41748

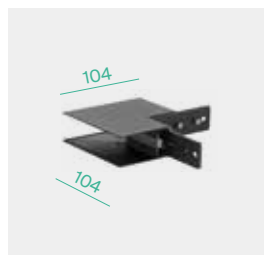

41751 - 41752



41749 - 41750

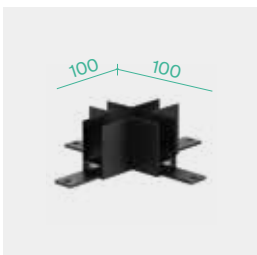

41753 - 41754

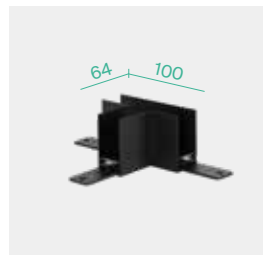

41755 - 41756



41759 - 41760

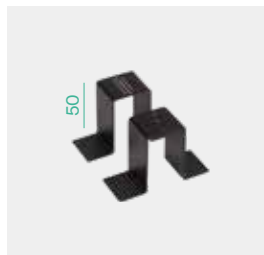

41763

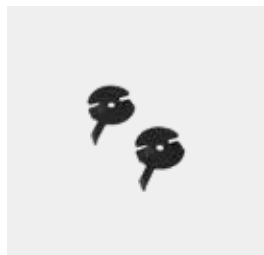

41761 - 41762

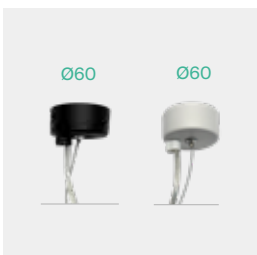

41132/A - 41133/A



41757 - 41758



41765 - 41766

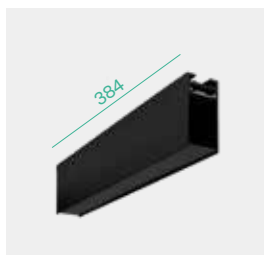

41784 - 41788



41785 - 41789 - 41786 - 41790



42817 - 42814



42818 - 42815 - 42819 - 42816

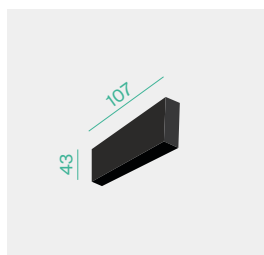

41780 - 41781

CODE	FINISHING	DESCRIPTION	KG
41713	Nero / Black	Struttura 1mt in alluminio estruso con testate / 1mt extruded aluminium profile with end-caps	1,14
41714	Bianco / White	Struttura 1mt in alluminio estruso con testate / 1mt extruded aluminium profile with end-caps	1,14
41715	Nero / Black	Struttura 2mt in alluminio estruso con testate / 2mt extruded aluminium profile with end-caps	2,28
41716	Bianco / White	Struttura 2mt in alluminio estruso con testate / 2mt extruded aluminium profile with end-caps	2,28

KLIK_KLAK MINI ACCESSORI ACCESSORIES

CODE	FINISHING	DESCRIPTION	KG
41764	Nero / Black	Copertura per rasatura 1 mt / 1mt mask for plasterboard thinning	
41747	Nero / Black	Angolo 90° con spinotti e accessori / 90° corner with accessories	
41748	Bianco / White	Angolo 90° con spinotti e accessori / 90° corner with accessories	
41751	Nero / Black	Angolo 90° esterno e accessori / Outer 90° corner with accessories	
41752	Bianco / White	Angolo 90° esterno e accessori / Outer 90° corner with accessories	
41749	Nero / Black	Angolo 90° interno e accessori / Inner 90° corner with accessories	
41750	Bianco / White	Angolo 90° interno e accessori / Inner 90° corner with accessories	
41759	Nero / Black	Congiunzione elettrica con spinotti / Linear electric connection with relative 3-pins connector	
41760	Bianco / White	Congiunzione elettrica con spinotti / Linear electric connection with relative 3-pins connector	
41763	Nero / Black	Kit staffe incasso (2 pz) / Brackets for recessed installation (2 pcs)	
41761	Nero / Black	Staffe attacco soffitto kit 2pz / Brackets for ceiling installation 2 pcs	
41762	Bianco / White	Staffe attacco soffitto kit 2pz / Brackets for ceiling installation 2 pcs	
41132	Acciaio/Steel	Sospensione 2mt (1 pz) / Suspension 2mt (1 pc)	
41132/A	Nero / Black	Sospensione con cavo alimentazione 2mt (1 pz) / Suspension 2mt with electrical wire (1 pc)	
41133/A	Bianco / White	Sospensione con cavo alimentazione 2mt (1 pz) / Suspension 2mt with electrical wire (1 pc)	
41757	Nero / Black	Staffa connessione (1 pz) / Linear connection plate (1 pc)	
41758	Bianco / White	Staffa connessione (1 pz) / Linear connection plate (1 pc)	
41753	Nero / Black	Giunto a "X"/"X" connector	
41754	Bianco / White	Giunto a "X"/"X" connector	
41755	Nero / Black	Giunto a "T"/"T" connector	
41756	Bianco / White	Giunto a "T"/"T" connector	
41765	Nero / Black	Testata per alimentazione 24V / Front feed 24V	
41766	Bianco / White	Testata per alimentazione 24V / Front feed 24V	
41780	Nero / Black	Ponte di giunzione elettrica 107mm H.43mm / Electric bridge connector 107mm H.43mm	
41781	Bianco / White	Ponte di giunzione elettrica 107mm H.43mm / Electric bridge connector 107mm H.43mm	
41784	Nero / Black	Testata c/ driver 60W 230V dimm. / Front feed w/ driver 60W 230V dimm.	0,70
41788	Bianco / White	Testata c/ driver 60W 230V dimm. / Front feed w/ driver 60W 230V dimm.	0,70
41785	Nero / Black	Testata c/ driver 100W 230V dimm. / Front feed w/ driver 100W 230V dimm.	0,80
41789	Bianco / White	Testata c/ driver 100W 230V dimm. / Front feed w/ driver 100W 230V dimm.	0,80
41786	Nero / Black	Testata c/ driver 150W 230V dimm. / Front feed w/ driver 150W 230V dimm.	0,80
41790	Bianco / White	Testata c/ driver 150W 230V dimm. / Front feed w/ driver 150W 230V dimm.	0,80
42817	Nero / Black	Centrale c/ driver 60W 230V dimm. / Central feed w/ driver 60W 230V dimm.	0,72
42814	Bianco / White	Centrale c/ driver 60W 230V dimm. / Central feed w/ driver 60W 230V dimm.	0,72
42818	Nero / Black	Centrale c/ driver 100W 230V dimm. / Central feed w/ driver 100W 230V dimm.	0,82
42815	Bianco / White	Centrale c/ driver 100W 230V dimm. / Central feed w/ driver 100W 230V dimm.	0,82
42819	Nero / Black	Centrale c/ driver 150W 230V dimm. / Central feed w/ driver 150W 230V dimm.	0,82
42816	Bianco / White	Centrale c/ driver 150W 230V dimm. / Central feed w/ driver 150W 230V dimm.	0,82

DRIVER

CODE	WATT	VOLT	DESCRIPTION	MODE	SIZE
22015	50W	24V DC	Driver MW	ON-OFF	99x82x30mm
22031	60W	24V DC	Driver EAGLERISE TRP	ON-OFF	187x45x31mm
22032	75W	24V DC	Driver EAGLERISE TRP	ON-OFF	187x45x31mm
22016	100W	24V DC	Driver MW	ON-OFF	129x97x30mm
22033	120W	24V DC	Driver EAGLERISE TRP	ON-OFF	268x45x31mm
22034	150W	24V DC	Driver EAGLERISE TRP	ON-OFF	268x45x31mm
22025	150W	24V DC	Driver MW	ON-OFF	160x95x30mm
22017	200W	24V DC	Driver MW	ON-OFF	215x115x30mm
41217	75W	24V DC	Driver dimmerabile LTECH	0-10V	294x43x30mm
41218	100W	24V DC	Driver dimmerabile LTECH	0-10V	240x70x36mm
41219	150W	24V DC	Driver dimmerabile LTECH	0-10V	354x43x30mm
11044	75W	24V DC	Driver LTECH	DALI	290x45x30mm
11045	150W	24V DC	Driver LTECH	DALI	290x45x30mm
11043	240W	24V DC	Driver LTECH	DALI	380x50x30mm

Klik_Klak Micro

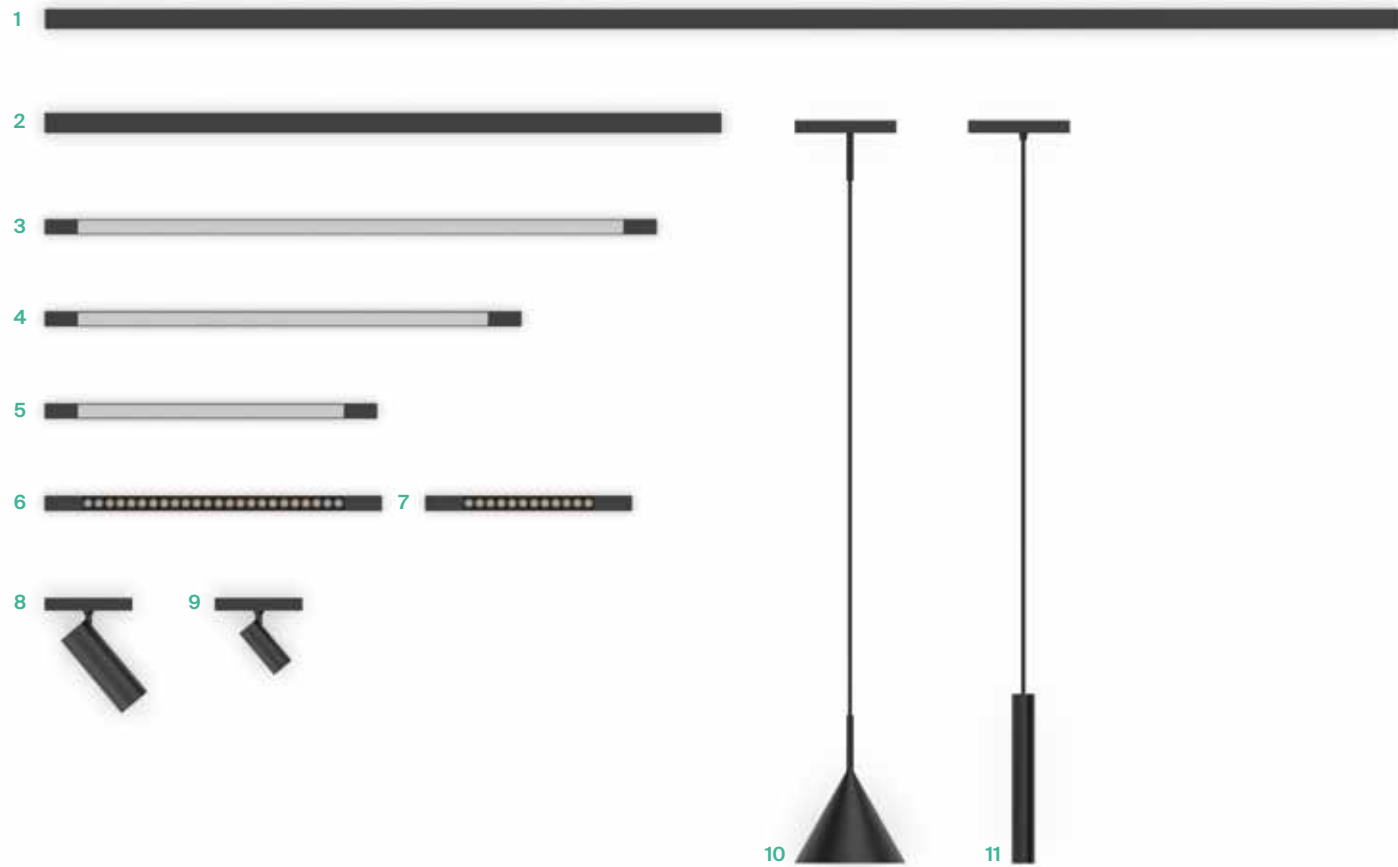

- 1 Binario 2mt
2m profile
- 2 Binario 1mt
1m profile
- 3 Luce diffusa 24W
Wide beam general lighting 24W
- 4 Luce diffusa 18W
Wide beam general lighting 18W

- 5 Luce diffusa 12W
Wide beam general lighting 12W
- 6 Luce puntiforme x24
Dots light x24
- 7 Luce puntiforme x12
Dots light x12
- 8 Proiettore 10W
Spotlight 10W

- 9 Proiettore 6W
Spotlight 6W
- 10 Sospensione bell
Suspension bell
- 11 Sospensione cilindro
Suspension cylinder



KLIK_KLAK MICRO PROIETTORE



LED CREE
CRI >90
PF >0,5
SDCM <3

CODE	FINISHING	WATT	LUMEN	WATT LIGHT SOURCE	LUMEN LIGHT SOURCE	BEAM	KELVIN	KG
42835	Nero/Black	6W	423	5W	630	30°	3000K	0,20
42836	Bianco/White	6W	423	5W	630	30°	3000K	0,20
42837	Nero/Black	10W	749	8W	900	36°	3000K	0,20
42838	Bianco/White	10W	749	8W	900	36°	3000K	0,20

INSTALLAZIONE APPLICATION

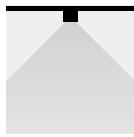

Binario magnetico/
Magnetic track

DISEGNI TECNICI TECHNICAL DRAWINGS

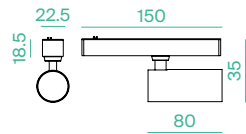

42835
42836

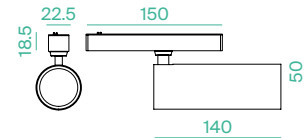

42837
42838

REGOLAZIONI ADJUSTABILITY



KLIK_KLAK MICRO LUCÈ DIFFUSA

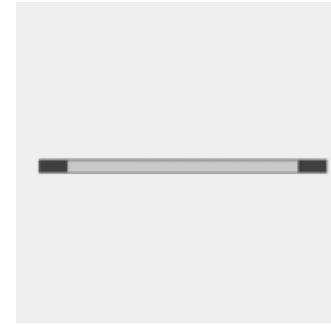

LED CREE
CRI >90
PF >0,7
SDCM <3

CODE	FINISHING	WATT	LUMEN	WATT LIGHT SOURCE	LUMEN LIGHT SOURCE	BEAM	KELVIN	KG
42829	Nero/Black	12W	862	9W	1393	105°	3000K	0,25
42830	Bianco/White	12W	862	9W	1393	105°	3000K	0,25
42831	Nero/Black	18W	1270	14W	2067	105°	3000K	0,25
42832	Bianco/White	18W	1270	14W	2067	105°	3000K	0,25
42833	Nero/Black	24W	1705	18W	2752	105°	3000K	0,25
42834	Bianco/White	24W	1705	18W	2752	105°	3000K	0,25

INSTALLAZIONE APPLICATION

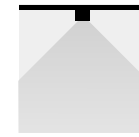

Binario magnetico/
Magnetic track

DISEGNI TECNICI TECHNICAL DRAWINGS

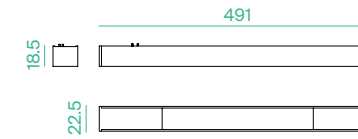

42829
42830



42831
42832

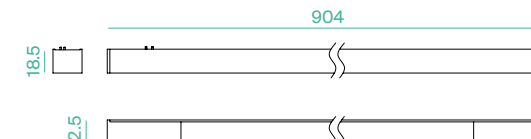

42833
42834

KLIK_KLAK MICRO PUNTIFORME



LED CREE
CRI >90
PF >0,7
SDCM <3

CODE	FINISHING	WATT	LUMEN	WATT LIGHT SOURCE	LUMEN LIGHT SOURCE	BEAM	KELVIN	KG
42825	Nero/Black	12W	1011	10W	1410	30°	3000K	0,15
42826	Bianco/White	12W	1011	10W	1410	30°	3000K	0,15
42827	Nero/Black	24W	2041	20W	2750	30°	3000K	0,15
42828	Bianco/White	24W	2041	20W	2750	30°	3000K	0,15

INSTALLAZIONE APPLICATION

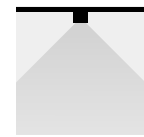

Binario magnetico/
Magnetic track

DISEGNI TECNICI TECHNICAL DRAWINGS

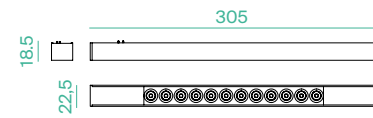

42825
42826

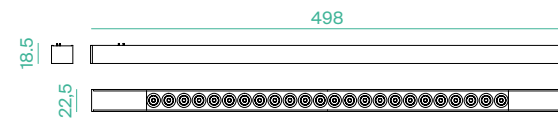

42827
42828

KLIK_KLAK MICRO SOSPENSIONE

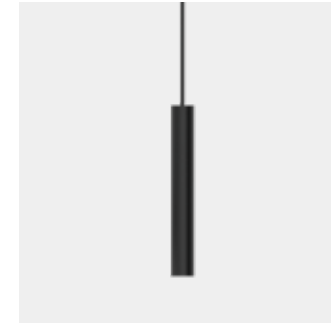

LED CREE
CRI >90
PF >0,5
SDCM <3

CODE	FINISHING	WATT	LUMEN	WATT LIGHT SOURCE	LUMEN LIGHT SOURCE	BEAM	KELVIN	KG
42839	Nero/Black	6W	423	5W	630	30°	3000K	0,45
42840	Bianco/White	6W	423	5W	630	30°	3000K	0,45

INSTALLAZIONE APPLICATION

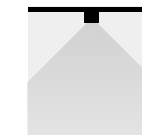

Binario magnetico/
Magnetic track

DISEGNI TECNICI TECHNICAL DRAWINGS

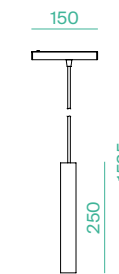

KLIK_KLAK MICRO SOSPENSIONE BELL

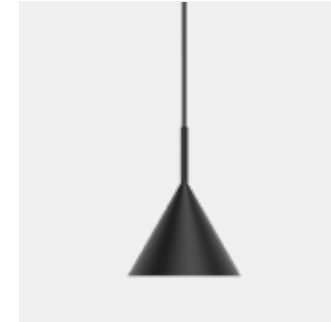

LED CREE
CRI >90
PF >0,5
SDCM <3

CODE	FINISHING	WATT	LUMEN	WATT LIGHT SOURCE	LUMEN LIGHT SOURCE	BEAM	KELVIN	KG
42841	Nero/Black	10W	415	8W	900	65°	3000K	0,40
42842	Bianco/White	10W	571	8W	900	65°	3000K	0,40

INSTALLAZIONE APPLICATION

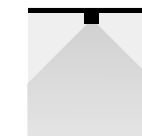

Binario magnetico/
Magnetic track

DISEGNI TECNICI TECHNICAL DRAWINGS

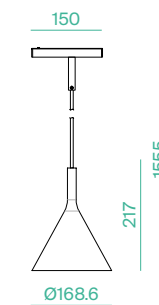

KLIK_KLAK MICRO ACCESSORI ACCESSORIES

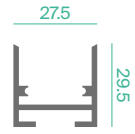

42843 - 42844



42845 - 42846

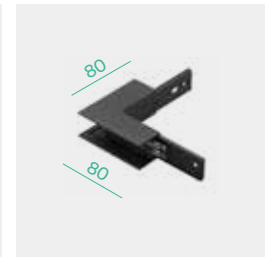

42847 - 42848

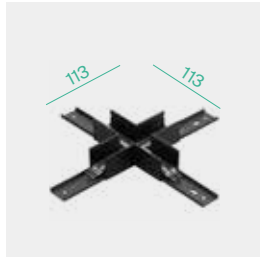

42849 - 42850

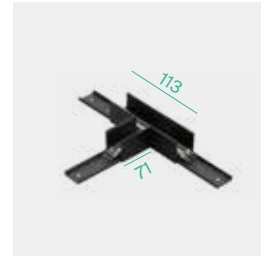

42851 - 42852

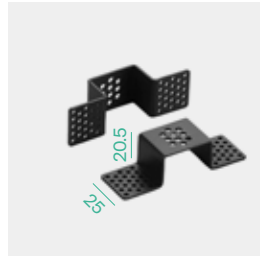

42853

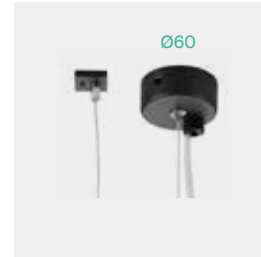

42854 - 42855

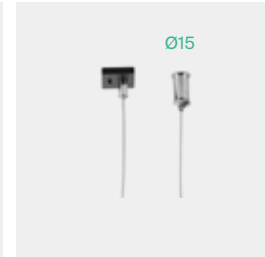

42856 - 42857

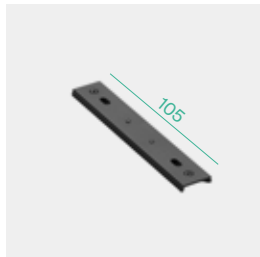

42858-42859



41759 - 41760



42862-42863

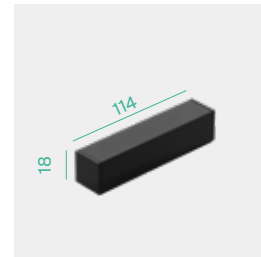

42864-42865

CODE	FINISHING	DESCRIPTION	KG
42821	Nero / Black	Struttura 1mt in alluminio estruso con testate/ 1mt extruded aluminium profile with end-caps	0,80
42822	Bianco / White	Struttura 1mt in alluminio estruso con testate/ 1mt extruded aluminium profile with end-caps	0,80
42823	Nero / Black	Struttura 2mt in alluminio estruso con testate/ 2mt extruded aluminium profile with end-caps	1,55
42824	Bianco / White	Struttura 2mt in alluminio estruso con testate/ 2mt extruded aluminium profile with end-caps	1,55

KLIK_KLAK MICRO ACCESSORI ACCESSORIES

CODE	FINISHING	DESCRIPTION
41764	Nero / Black	Copertura per rasatura 1 mt /1 mt mask for plasterboard thinning
42843	Nero / Black	Angolo 90° con spinotti e accessori/ 90° corner with accessories
42844	Bianco / White	Angolo 90° con spinotti e accessori/ 90° corner with accessories
42845	Nero / Black	Angolo 90° interno e accessori/ Inner 90° corner with accessories
42846	Bianco / White	Angolo 90° interno e accessori/ Inner 90° corner with accessories
42847	Nero / Black	Angolo 90° esterno e accessori/ Outer 90° corner with accessories
42848	Bianco / White	Angolo 90° esterno e accessori/ Outer 90° corner with accessories
42849	Nero / Black	Giunto a "X"/"X" connector
42850	Bianco / White	Giunto a "X"/"X" connector
42851	Nero / Black	Giunto a "T"/"T" connector
42852	Bianco / White	Giunto a "T"/"T" connector
42853	Nero / Black	Kit staffe incasso (2 pz) / Brackets for recessed installation (2 pcs)
42854	Nero / Black	Sospensione con cavo alimentazione 2mt (1 pz) / Suspension 2mt with electrical wire (1 pc)
42855	Bianco / White	Sospensione con cavo alimentazione 2mt (1 pz) / Suspension 2mt with electrical wire (1 pc)
42856	Nero / Black	Sospensione 2mt (1 pz) / Suspension 2mt (1 pc)
42857	Bianco / White	Sospensione 2mt (1 pz) / Suspension 2mt (1 pc)
42858	Nero / Black	Staffa connessione (1 pz) / Linear connection plate (1 pc)
42859	Bianco / White	Staffa connessione (1 pz) / Linear connection plate (1 pc)
41759	Nero / Black	Congiunzione elettrica con spinotti/ Linear electric connection with relative 3-pins connector
41760	Bianco / White	Congiunzione elettrica con spinotti/ Linear electric connection with relative 3-pins connector
42862	Nero / Black	Staffe attacco soffitto kit 2pz / Brackets for ceiling installation 2 pcs
42863	Bianco / White	Staffe attacco soffitto kit 2pz / Brackets for ceiling installation 2 pcs
42864	Nero / Black	Ponte di giunzione elettrica 114mm H.18mm/Electric bridge connector 114mm H.18mm
42865	Bianco / White	Ponte di giunzione elettrica 114mm H.18mm/Electric bridge connector 114mm H.18mm

DRIVER

CODE	WATT	VOLT	DESCRIPTION	MODE	SIZE
22015	50W	24V DC	Driver MW	ON-OFF	99x82x30mm
22031	60W	24V DC	Driver EAGLERISE TRP	ON-OFF	187x45x31mm
22032	75W	24V DC	Driver EAGLERISE TRP	ON-OFF	187x45x31mm
22016	100W	24V DC	Driver MW	ON-OFF	129x97x30mm
22033	120W	24V DC	Driver EAGLERISE TRP	ON-OFF	268x45x31mm
22034	150W	24V DC	Driver EAGLERISE TRP	ON-OFF	268x45x31mm
22025	150W	24V DC	Driver MW	ON-OFF	160x95x30mm
22017	200W	24V DC	Driver MW	ON-OFF	215x115x30mm
41217	75W	24V DC	Driver dimmerabile LTECH	0-10V	294x43x30mm
41218	100W	24V DC	Driver dimmerabile LTECH	0-10V	240x70x36mm
41219	150W	24V DC	Driver dimmerabile LTECH	0-10V	354x43x30mm
11044	75W	24V DC	Driver LTECH	DALI	290x45x30mm
11045	150W	24V DC	Driver LTECH	DALI	290x45x30mm
11043	240W	24V DC	Driver LTECH	DALI	380x50x30mm

TRACK

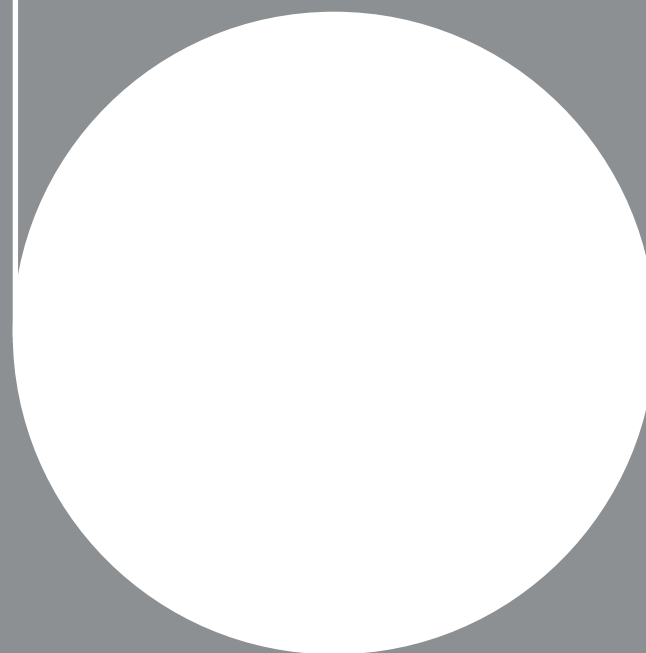
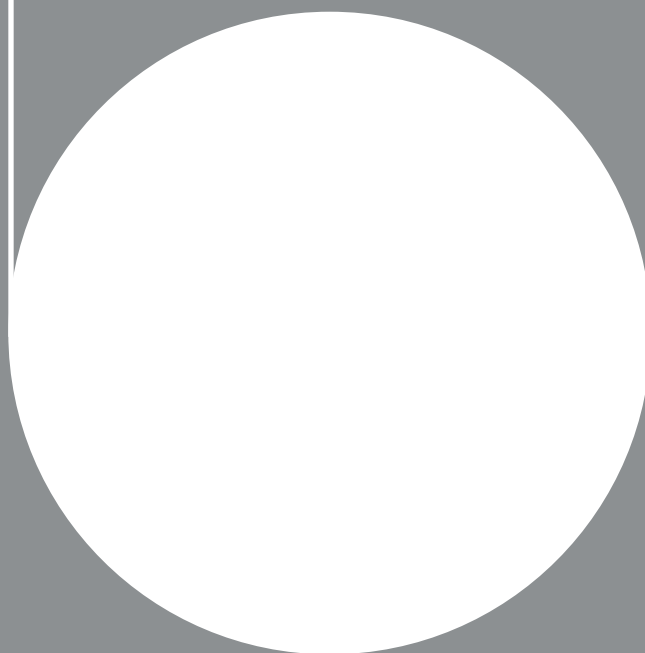
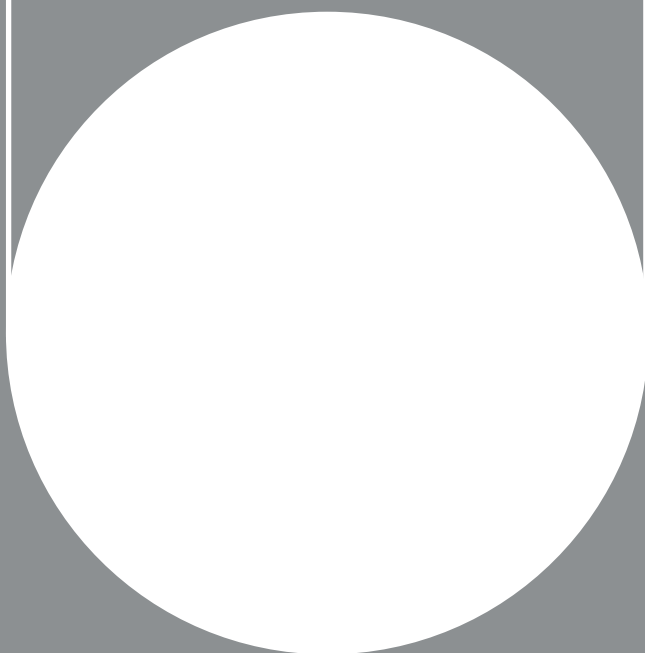
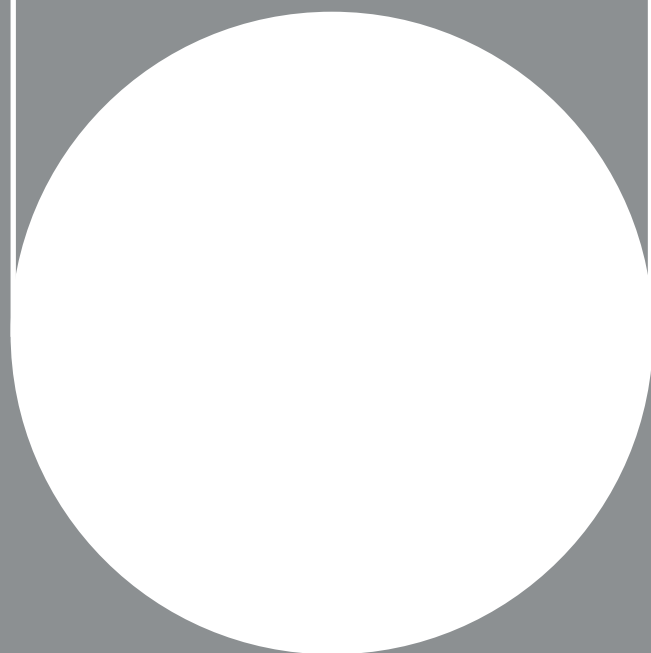

Fulgor



Proiettore LED integrato orientabile
Corpo in alluminio pressofuso verniciato
Driver integrato

*LED adjustable tracklight
Painted die-cast aluminium body
Driver box on track*

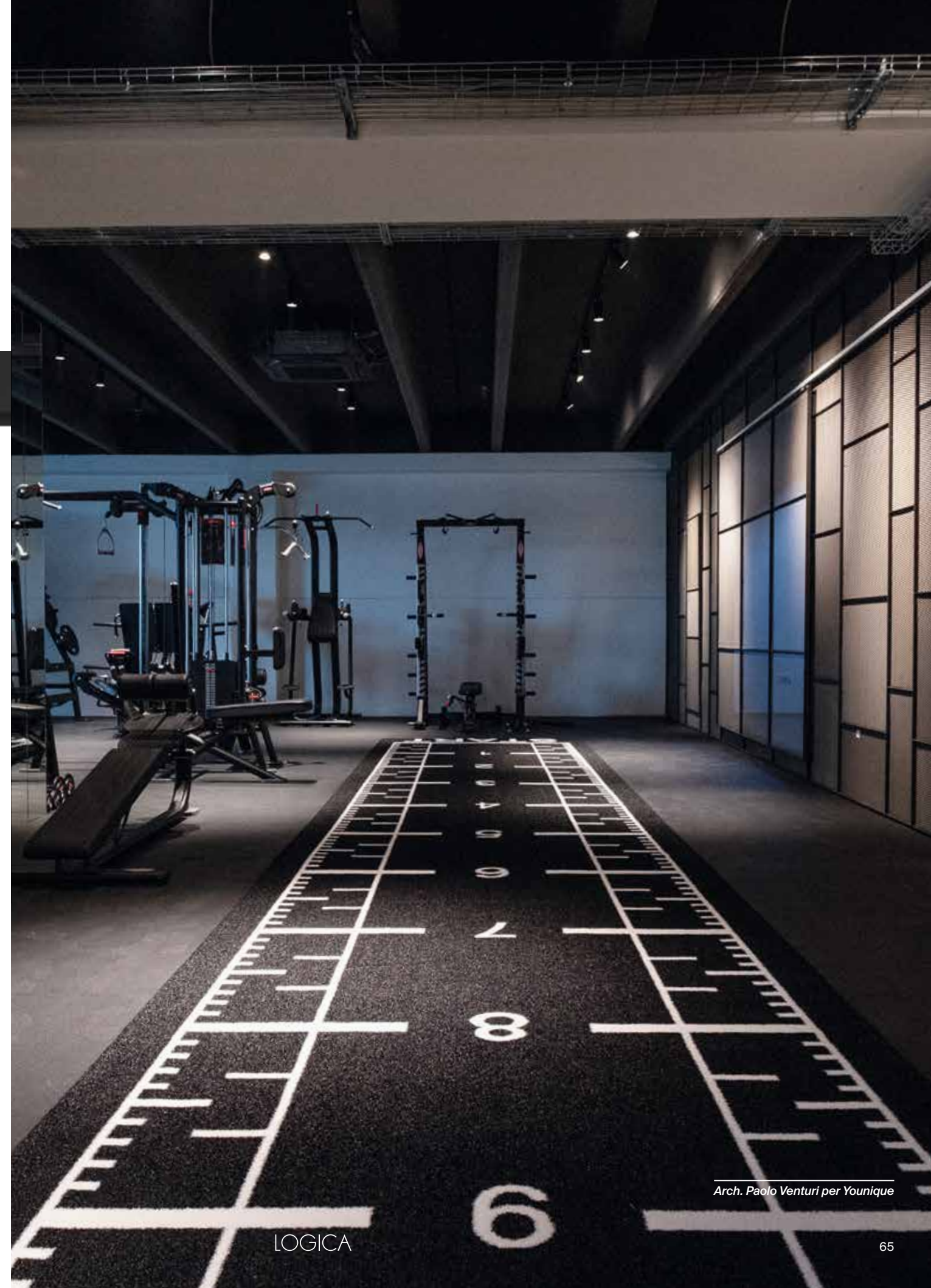

Arch. Paolo Venturi per Younique

LOGICA

Applicazione versatile

Versatile application



La gamma FULGOR consente di costruire il sistema a binario sulle singole esigenze progettuali. Le potenze disponibili di 15W, 24W e 35W - unitamente alla varietà di ottiche (15°, 24°, 38° e 55°) - permettono un controllo preciso del fascio luminoso, garantendo la perfetta messa in risalto di ogni dettaglio.

La gestione dell'alimentazione, disponibile in modalità ON-OFF, taglio di fase o DALI-PUSH, consente una regolazione ottimale delle intensità luminose e la creazione di ambienti di luce funzionali.

The FULGOR range allows building the track system tailored to the design needs of spaces. The available powers of 15W, 24W, and 35W - along with the variety of optics (15°, 24°, 38°, and 55°) - enable precise control of the light beam, ensuring perfect highlighting of every detail.

The advanced power management, available ON-OFF, phase cut or DALI-PUSH, offers unparalleled control, allowing optimal adjustment of light intensities and the creation of functional lighting environments.

Realizzati con precisione in alluminio per pressofusione, la famiglia di prodotti FULGOR combina eleganza e funzionalità, offrendo soluzioni adatte a ogni necessità architettonica.

Crafted precisely in die-cast aluminum, the FULGOR product family blends elegance and functionality, providing solutions suitable for every architectural need.



Da sinistra a destra:
FULGOR con basetta
FULGOR_IN
FULGOR a binario

*From left to right:
FULGOR with base
FULGOR_IN
FULGOR track*

FULGOR 15W



LED BRIDGELUX
CRI >90
PF >0,9
SDCM ≥3

CODE	FINISHING	WATT	LUMEN	WATT LIGHT SOURCE	LUMEN LIGHT SOURCE	BEAM	KELVIN	VOLT	KG
41797	Bianco/ White	15W	1560	14,8W	1710	15°	3000K	36-38V 350mA	0,40
41811	Nero/Black	15W	1560	14,8W	1710	15°	3000K	36-38V 350mA	0,40
41804	Bianco/ White	15W	1557	14,8W	1834	15°	4000K	36-38V 350mA	0,40
41818	Nero/Black	15W	1557	14,8W	1834	15°	4000K	36-38V 350mA	0,40
41798	Bianco/ White	15W	1574	14,8W	1710	24°	3000K	36-38V 350mA	0,40
41812	Nero/Black	15W	1574	14,8W	1710	24°	3000K	36-38V 350mA	0,40
41805	Bianco/ White	15W	1584	14,8W	1834	24°	4000K	36-38V 350mA	0,40
41819	Nero/Black	15W	1584	14,8W	1834	24°	4000K	36-38V 350mA	0,40
41799	Bianco/ White	15W	1591	14,8W	1710	38°	3000K	36-38V 350mA	0,40
41813	Nero/Black	15W	1591	14,8W	1710	38°	3000K	36-38V 350mA	0,40
41806	Bianco/ White	15W	1585	14,8W	1834	38°	4000K	36-38V 350mA	0,40
41820	Nero/Black	15W	1585	14,8W	1834	38°	4000K	36-38V 350mA	0,40
41800	Bianco/ White	15W	1509	14,8W	1710	55°	3000K	36-38V 350mA	0,40
41814	Nero/Black	15W	1509	14,8W	1710	55°	3000K	36-38V 350mA	0,40
41807	Bianco/ White	15W	1531	14,8W	1834	55°	4000K	36-38V 350mA	0,40
41821	Nero/Black	15W	1531	14,8W	1834	55°	4000K	36-38V 350mA	0,40

INSTALLAZIONE APPLICATION

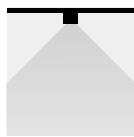

Binario/Track

DISEGNI TECNICI TECHNICAL DRAWINGS

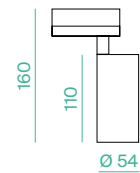

REGOLAZIONI ADJUSTABILITY



ACCESSORI ACCESSORIES

CODE	DESCRIPTION
71575	Filtro honeycomb 15W/Honeycomb filter 15W

FULGOR 15W DALI-PUSH



LED BRIDGELUX
CRI >90
PF >0,9
SDCM ≥3

CODE	FINISHING	WATT	LUMEN	WATT LIGHT SOURCE	LUMEN LIGHT SOURCE	BEAM	KELVIN	VOLT	KG
41825	Bianco/ White	15W	1560	14,8W	1710	15°	3000K	36-38V 350mA	0,40
41847	Nero/Black	15W	1560	14,8W	1710	15°	3000K	36-38V 350mA	0,40
41836	Bianco/ White	15W	1557	14,8W	1834	15°	4000K	36-38V 350mA	0,40
41858	Nero/Black	15W	1557	14,8W	1834	15°	4000K	36-38V 350mA	0,40
41826	Bianco/ White	15W	1574	14,8W	1710	24°	3000K	36-38V 350mA	0,40
41848	Nero/Black	15W	1574	14,8W	1710	24°	3000K	36-38V 350mA	0,40
41837	Bianco/ White	15W	1584	14,8W	1834	24°	4000K	36-38V 350mA	0,40
41859	Nero/Black	15W	1584	14,8W	1834	24°	4000K	36-38V 350mA	0,40
41827	Bianco/ White	15W	1591	14,8W	1710	38°	3000K	36-38V 350mA	0,40
41849	Nero/Black	15W	1591	14,8W	1710	38°	3000K	36-38V 350mA	0,40
41838	Bianco/ White	15W	1585	14,8W	1834	38°	4000K	36-38V 350mA	0,40
41860	Nero/Black	15W	1585	14,8W	1834	38°	4000K	36-38V 350mA	0,40
41828	Bianco/ White	15W	1509	14,8W	1710	55°	3000K	36-38V 350mA	0,40
41850	Nero/Black	15W	1509	14,8W	1710	55°	3000K	36-38V 350mA	0,40
41839	Bianco/ White	15W	1531	14,8W	1834	55°	4000K	36-38V 350mA	0,40
41861	Nero/Black	15W	1531	14,8W	1834	55°	4000K	36-38V 350mA	0,40

INSTALLAZIONE APPLICATION

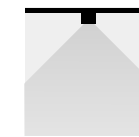

Binario/Track

DISEGNI TECNICI TECHNICAL DRAWINGS

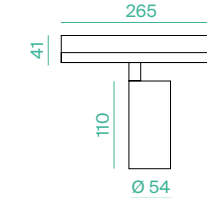

REGOLAZIONI ADJUSTABILITY



ACCESSORI ACCESSORIES

CODE	DESCRIPTION
71575	Filtro honeycomb 15W/Honeycomb filter 15W

FULGOR 24W



LED BRIDGELUX
CRI >90
PF >0,9
SDCM ≥3

CODE	FINISHING	WATT	LUMEN	WATT LIGHT SOURCE	LUMEN LIGHT SOURCE	BEAM	KELVIN	VOLT	KG
41678	Bianco/ White	24W	2220	24W	2640	15°	3000K	36-38V 600mA	0,60
41679	Nero/Black	24W	2220	24W	2640	15°	3000K	36-38V 600mA	0,60
41680	Bianco/ White	24W	2400	24W	2880	15°	4000K	36-38V 600mA	0,60
41681	Nero/Black	24W	2400	24W	2880	15°	4000K	36-38V 600mA	0,60
41674	Bianco/ White	24W	2280	24W	2640	24°	3000K	36-38V 600mA	0,60
41675	Nero/Black	24W	2280	24W	2640	24°	3000K	36-38V 600mA	0,60
41676	Bianco/ White	24W	2480	24W	2880	24°	4000K	36-38V 600mA	0,60
41677	Nero/Black	24W	2480	24W	2880	24°	4000K	36-38V 600mA	0,60
41670	Bianco/ White	24W	2340	24W	2640	38°	3000K	36-38V 600mA	0,60
41671	Nero/Black	24W	2340	24W	2640	38°	3000K	36-38V 600mA	0,60
41672	Bianco/ White	24W	2550	24W	2880	38°	4000K	36-38V 600mA	0,60
41673	Nero/Black	24W	2550	24W	2880	38°	4000K	36-38V 600mA	0,60
41666	Bianco/ White	24W	2310	24W	2640	55°	3000K	36-38V 600mA	0,60
41668	Nero/Black	24W	2310	24W	2640	55°	3000K	36-38V 600mA	0,60
41667	Bianco/ White	24W	2510	24W	2880	55°	4000K	36-38V 600mA	0,60
41669	Nero/Black	24W	2510	24W	2880	55°	4000K	36-38V 600mA	0,60

INSTALLAZIONE APPLICATION

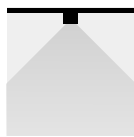

Binario/Track

DISEGNI TECNICI TECHNICAL DRAWINGS

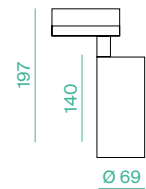

REGOLAZIONI ADJUSTABILITY



ACCESSORI ACCESSORIES

CODE	DESCRIPTION
71663	Filtro honeycomb 24W/Honeycomb filter 24W

FULGOR 24W DALI-PUSH



LED BRIDGELUX
CRI >90
PF >0,9
SDCM ≥3

CODE	FINISHING	WATT	LUMEN	WATT LIGHT SOURCE	LUMEN LIGHT SOURCE	BEAM	KELVIN	VOLT	KG
41829	Bianco/ White	24W	2220	24W	2640	15°	3000K	36-38V 600mA	0,60
41851	Nero/Black	24W	2220	24W	2640	15°	3000K	36-38V 600mA	0,60
41840	Bianco/ White	24W	2400	24W	2880	15°	4000K	36-38V 600mA	0,60
41862	Nero/Black	24W	2400	24W	2880	15°	4000K	36-38V 600mA	0,60
41830	Bianco/ White	24W	2280	24W	2640	24°	3000K	36-38V 600mA	0,60
41852	Nero/Black	24W	2280	24W	2640	24°	3000K	36-38V 600mA	0,60
41841	Bianco/ White	24W	2480	24W	2880	24°	4000K	36-38V 600mA	0,60
41863	Nero/Black	24W	2480	24W	2880	24°	4000K	36-38V 600mA	0,60
41831	Bianco/ White	24W	2340	24W	2640	38°	3000K	36-38V 600mA	0,60
41853	Nero/Black	24W	2340	24W	2640	38°	3000K	36-38V 600mA	0,60
41842	Bianco/ White	24W	2550	24W	2880	38°	4000K	36-38V 600mA	0,60
41864	Nero/Black	24W	2550	24W	2880	38°	4000K	36-38V 600mA	0,60
41832	Bianco/ White	24W	2310	24W	2640	55°	3000K	36-38V 600mA	0,60
41854	Nero/Black	24W	2310	24W	2640	55°	3000K	36-38V 600mA	0,60
41843	Bianco/ White	24W	2510	24W	2880	55°	4000K	36-38V 600mA	0,60
41865	Nero/Black	24W	2510	24W	2880	55°	4000K	36-38V 600mA	0,60

INSTALLAZIONE APPLICATION

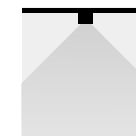

Binario/Track

DISEGNI TECNICI TECHNICAL DRAWINGS

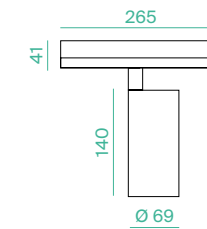

REGOLAZIONI ADJUSTABILITY



ACCESSORI ACCESSORIES

CODE	DESCRIPTION
71663	Filtro honeycomb 24W/Honeycomb filter 24W

FULGOR 35W



LED BRIDGELUX
CRI >90
PF >0,9
SDCM ≥3

CODE	FINISHING	WATT	LUMEN	WATT LIGHT SOURCE	LUMEN LIGHT SOURCE	BEAM	KELVIN	VOLT	KG
41801	Bianco/ White	35W	3267	33,5W	3705	15°	3000K	36-38V 850mA	0,86
41815	Nero/Black	35W	3267	33,5W	3705	15°	3000K	36-38V 850mA	0,86
41808	Bianco/ White	35W	3405	33,5W	3973	15°	4000K	36-38V 850mA	0,86
41822	Nero/Black	35W	3405	33,5W	3973	15°	4000K	36-38V 850mA	0,86
41802	Bianco/ White	35W	3408	33,5W	3705	24°	3000K	36-38V 850mA	0,86
41816	Nero/Black	35W	3408	33,5W	3705	24°	3000K	36-38V 850mA	0,86
41809	Bianco/ White	35W	3462	33,5W	3973	24°	4000K	36-38V 850mA	0,86
41823	Nero/Black	35W	3462	33,5W	3973	24°	4000K	36-38V 850mA	0,86
41803	Bianco/ White	35W	3370	33,5W	3705	38°	3000K	36-38V 850mA	0,86
41817	Nero/Black	35W	3370	33,5W	3705	38°	3000K	36-38V 850mA	0,86
41810	Bianco/ White	35W	3483	33,5W	3973	38°	4000K	36-38V 850mA	0,86
41824	Nero/Black	35W	3483	33,5W	3973	38°	4000K	36-38V 850mA	0,86
41905	Bianco/ White	35W	3410	33,5W	3705	55°	3000K	36-38V 850mA	0,86
41906	Nero/Black	35W	3410	33,5W	3705	55°	3000K	36-38V 850mA	0,86
41907	Bianco/ White	35W	3451	33,5W	3973	55°	4000K	36-38V 850mA	0,86
41908	Nero/Black	35W	3451	33,5W	3973	55°	4000K	36-38V 850mA	0,86

INSTALLAZIONE APPLICATION

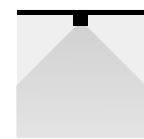

Binario/Track

DISEGNI TECNICI TECHNICAL DRAWINGS

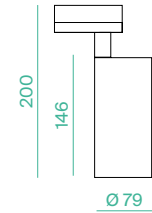

REGOLAZIONI ADJUSTABILITY



ACCESSORI ACCESSORIES

CODE	DESCRIPTION
71664	Filtro honeycomb 35W/Honeycomb filter 35W

FULGOR 35W DALI-PUSH



LED BRIDGELUX
CRI >90
PF >0,9
SDCM ≥3

CODE	FINISHING	WATT	LUMEN	WATT LIGHT SOURCE	LUMEN LIGHT SOURCE	BEAM	KELVIN	VOLT	KG
41833	Bianco/ White	35W	3267	33,5W	3705	15°	3000K	36-38V 850mA	0,86
41855	Nero/Black	35W	3267	33,5W	3705	15°	3000K	36-38V 850mA	0,86
41844	Bianco/ White	35W	3405	33,5W	3973	15°	4000K	36-38V 850mA	0,86
41866	Nero/Black	35W	3405	33,5W	3973	15°	4000K	36-38V 850mA	0,86
41834	Bianco/ White	35W	3408	33,5W	3705	24°	3000K	36-38V 850mA	0,86
41856	Nero/Black	35W	3408	33,5W	3705	24°	3000K	36-38V 850mA	0,86
41845	Bianco/ White	35W	3462	33,5W	3973	24°	4000K	36-38V 850mA	0,86
41867	Nero/Black	35W	3462	33,5W	3973	24°	4000K	36-38V 850mA	0,86
41835	Bianco/ White	35W	3370	33,5W	3705	38°	3000K	36-38V 850mA	0,86
41857	Nero/Black	35W	3370	33,5W	3705	38°	3000K	36-38V 850mA	0,86
41846	Bianco/ White	35W	3483	33,5W	3973	38°	4000K	36-38V 850mA	0,86
41868	Nero/Black	35W	3483	33,5W	3973	38°	4000K	36-38V 850mA	0,86
41909	Bianco/ White	35W	3410	33,5W	3705	55°	3000K	36-38V 850mA	0,86
41910	Nero/Black	35W	3410	33,5W	3705	55°	3000K	36-38V 850mA	0,86
41911	Bianco/ White	35W	3451	33,5W	3973	55°	4000K	36-38V 850mA	0,86
41912	Nero/Black	35W	3451	33,5W	3973	55°	4000K	36-38V 850mA	0,86

INSTALLAZIONE APPLICATION

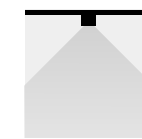

Binario/Track

DISEGNI TECNICI TECHNICAL DRAWINGS

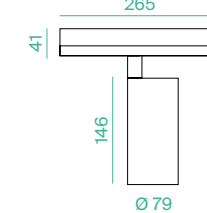

REGOLAZIONI ADJUSTABILITY



ACCESSORI ACCESSORIES

CODE	DESCRIPTION
71664	Filtro honeycomb 35W/Honeycomb filter 35W

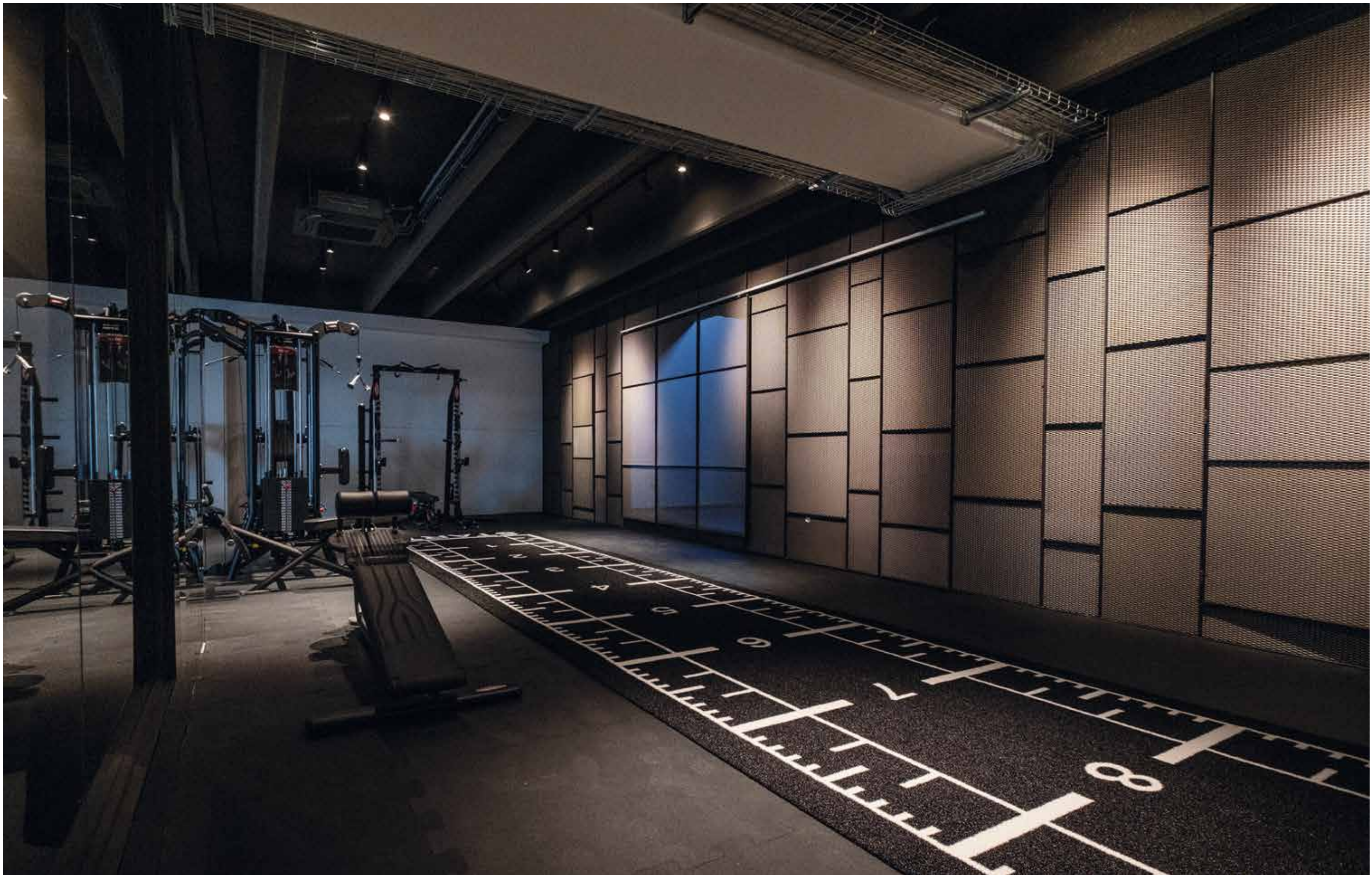

Arch. Paolo Venturi per Younique

Bombo



Proiettore LED integrato orientabile
Corpo in alluminio pressofuso verniciato
Driver integrato

*LED adjustable tracklight
Painted die-cast aluminium body
Driver box on track*

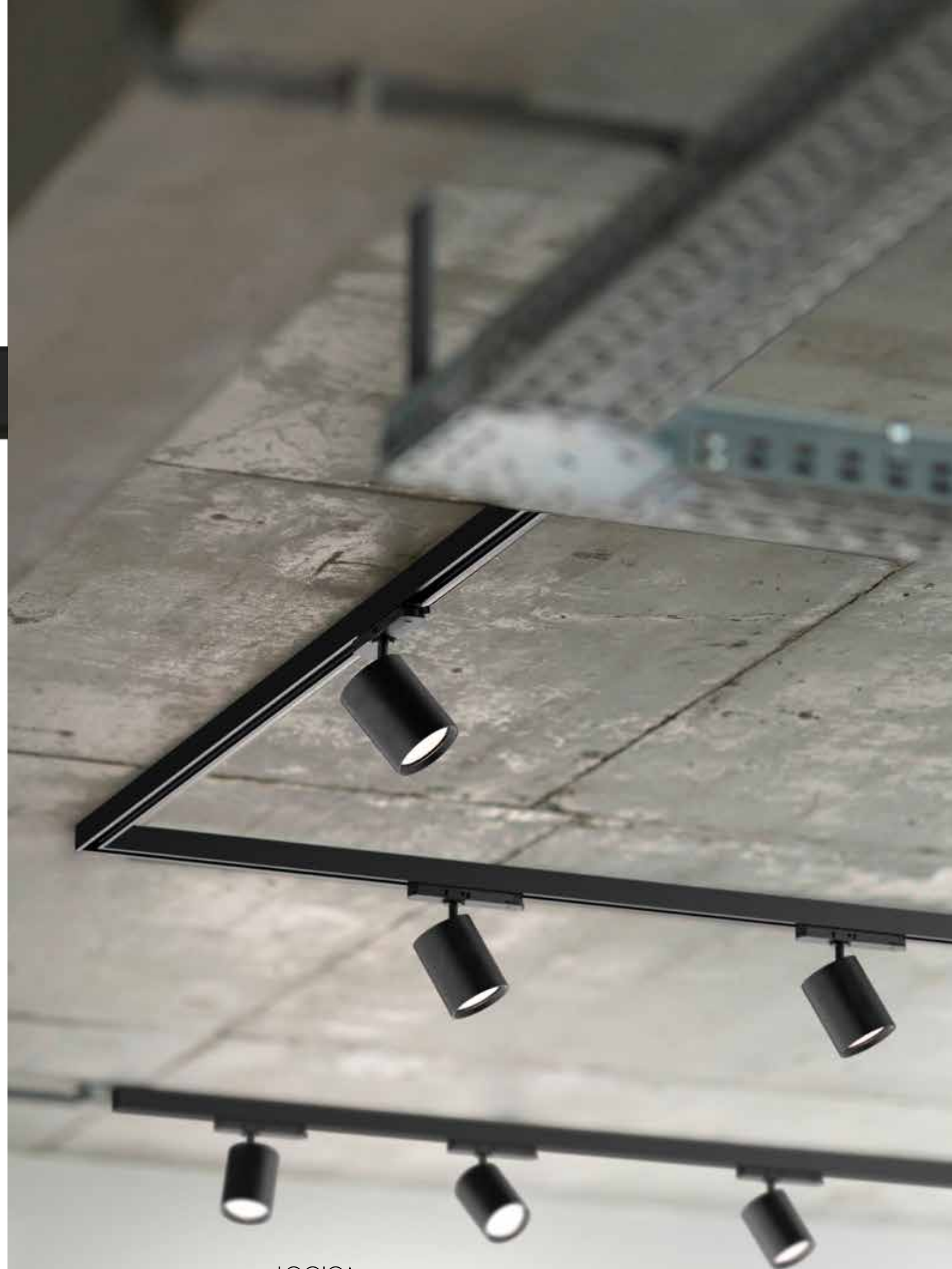

LOGICA

Applicazione versatile

Versatile application

24W

32W

15°

24°

38°

55°

La gamma BOMBO consente di costruire il sistema a binario sulle singole esigenze progettuali. Le potenze disponibili di 15W, 24W e 35W - unitamente alla varietà di ottiche (15°, 24°, 38° e 55°) - permettono un controllo preciso del fascio luminoso, garantendo la perfetta messa in risalto di ogni dettaglio.

The BOMBO range allows building the track system tailored to the design needs of spaces. The available powers of 15W, 24W, and 35W - along with the variety of optics (15°, 24°, 38°, and 55°) - enable precise control of the light beam, ensuring perfect highlighting of every detail.

BOMBO 24W



LED BRIDGELUX
CRI >90
PF 0,9
SDCM ≥3

CODE	FINISHING	WATT	LUMEN	WATT LIGHT SOURCE	LUMEN LIGHT SOURCE	BEAM	KELVIN	VOLT	KG
71974	Bianco/ White	24W	2189	22W	2780	15°	3000K	30-42V/600mA	0,46
71975	Nero/Black	24W	2189	22W	2780	15°	3000K	30-42V/600mA	0,46
71976	Bianco/ White	24W	2238	22W	2838	15°	4000K	30-42V/600mA	0,46
71977	Nero/Black	24W	2238	22W	2838	15°	4000K	30-42V/600mA	0,46
71978	Bianco/ White	24W	2167	22W	2780	24°	3000K	30-42V/600mA	0,46
71979	Nero/Black	24W	2167	22W	2780	24°	3000K	30-42V/600mA	0,46
71980	Bianco/ White	24W	2273	22W	2838	24°	4000K	30-42V/600mA	0,46
71981	Nero/Black	24W	2273	22W	2838	24°	4000K	30-42V/600mA	0,46
71982	Bianco/ White	24W	2125	22W	2780	38°	3000K	30-42V/600mA	0,46
71983	Nero/Black	24W	2125	22W	2780	38°	3000K	30-42V/600mA	0,46
71984	Bianco/ White	24W	2273	22W	2838	38°	4000K	30-42V/600mA	0,46
71985	Nero/Black	24W	2273	22W	2838	38°	4000K	30-42V/600mA	0,46
71986	Bianco/ White	24W	2100	22W	2780	55°	3000K	30-42V/600mA	0,46
71987	Nero/Black	24W	2100	22W	2780	55°	3000K	30-42V/600mA	0,46
71988	Bianco/ White	24W	2210	22W	2838	55°	4000K	30-42V/600mA	0,46
71989	Nero/Black	24W	2210	22W	2838	55°	4000K	30-42V/600mA	0,46

INSTALLAZIONE APPLICATION

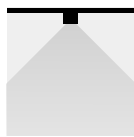

Binario/Track

DISEGNI TECNICI TECHNICAL DRAWINGS

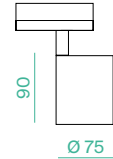

REGOLAZIONI ADJUSTABILITY



BOMBO 32W

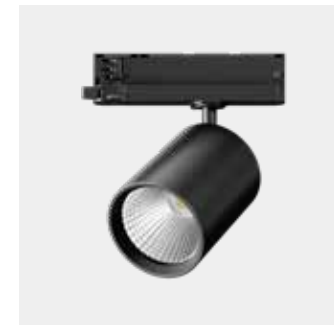

LED BRIDGELUX
CRI >90
PF 0,9
SDCM ≥3

CODE	FINISHING	WATT	LUMEN	WATT LIGHT SOURCE	LUMEN LIGHT SOURCE	BEAM	KELVIN	VOLT	KG
71998	Bianco/ White	32W	3005	29W	3820	15°	3000K	30-42V/800mA	0,59
71999	Nero/Black	32W	3005	29W	3820	15°	3000K	30-42V/800mA	0,59
72000	Bianco/ White	32W	3219	29W	4204	15°	4000K	30-42V/800mA	0,59
72001	Nero/Black	32W	3219	29W	4204	15°	4000K	30-42V/800mA	0,59
72002	Bianco/ White	32W	2895	29W	3820	24°	3000K	30-42V/800mA	0,59
72003	Nero/Black	32W	2895	29W	3820	24°	3000K	30-42V/800mA	0,59
72004	Bianco/ White	32W	3280	29W	4204	24°	4000K	30-42V/800mA	0,59
72005	Nero/Black	32W	3280	29W	4204	24°	4000K	30-42V/800mA	0,59
72006	Bianco/ White	32W	2877	29W	3820	38°	3000K	30-42V/800mA	0,59
72007	Nero/Black	32W	2877	29W	3820	38°	3000K	30-42V/800mA	0,59
72008	Bianco/ White	32W	3222	29W	4204	38°	4000K	30-42V/800mA	0,59
72009	Nero/Black	32W	3222	29W	4204	38°	4000K	30-42V/800mA	0,59
72010	Bianco/ White	32W	2861	29W	3820	55°	3000K	30-42V/800mA	0,59
72011	Nero/Black	32W	2861	29W	3820	55°	3000K	30-42V/800mA	0,59
72012	Bianco/ White	32W	3153	29W	4204	55°	4000K	30-42V/800mA	0,59
72013	Nero/Black	32W	3153	29W	4204	55°	4000K	30-42V/800mA	0,59

INSTALLAZIONE APPLICATION

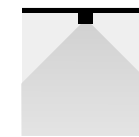

Binario/Track

DISEGNI TECNICI TECHNICAL DRAWINGS

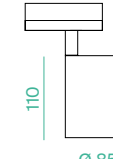

REGOLAZIONI ADJUSTABILITY



Sun_111



Proiettore GU10 per lampade QR111
Corpo in alluminio pressofuso verniciato

*GU10 projector for QR111 lamps
Die-cast painted aluminum body*



SUN_111 permette una illuminazione precisa e puntuale, fungendo da proiettore a binario o a base adattabile per installazioni a soffitto o parete. Realizzato con precisione in alluminio per pressofusione, il suo design minimale garantisce durabilità e fusione negli ambienti espositivi e commerciali.

SUN_111 enables precise and focused lighting, functioning either as a track spotlight or with a base for ceiling and wall installations. Crafted precisely from die-cast aluminum, its minimal design ensures durability and merging with display and commercial spaces.

SUN_111 TRACK



Lampadina esclusa / Bulb not included

CODE	FINISHING	BASE	WATT	VOLTAGE	KG
41913	Bianco/White	AR111 GU10	Max 50W	230V 50/60Hz	0,44
41914	Nero/Black	AR111 GU10	Max 50W	230V 50/60Hz	0,44

INSTALLAZIONE APPLICATION

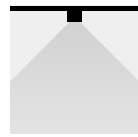

Binario/Track

DISEGNI TECNICI TECHNICAL DRAWINGS

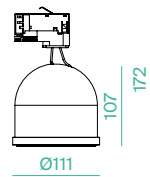

REGOLAZIONI ADJUSTABILITY



QR14LED REAL_COLOUR HIGH_OUTPUT

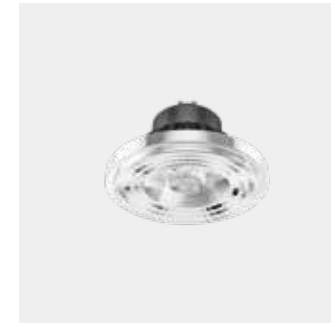

LED BRIDGELUX
PF 0,90
SDCM 3

Dimmer compatibili pag. 342
Compatible dimmers pag. 342

CODE	WATT	LUMEN 360°/CD	LUMEN 90°	BEAM	KELVIN	BASE	VOLT	MODE	CRI	KG
REAL COLOUR										
21773	14	1050/21000	1020	10°	2700°K	GU10	220-240	DIMM.	97	0,244
21774	14	1100/5500	1020	24°	2700°K	GU10	220-240	DIMM.	97	0,244
21775	14	1100/2750	1020	36°	2700°K	GU10	220-240	DIMM.	97	0,244
21776	14	1100/22000	1060	10°	3000°K	GU10	220-240	DIMM.	97	0,244
21777	14	1150/5750	1060	24°	3000°K	GU10	220-240	DIMM.	97	0,244
21778	14	1150/2875	1060	36°	3000°K	GU10	220-240	DIMM.	97	0,244
21779	14	1200/24000	1160	10°	4000°K	GU10	220-240	DIMM.	97	0,244
21780	14	1260/6300	1160	24°	4000°K	GU10	220-240	DIMM.	97	0,244
21781	14	1260/3150	1160	36°	4000°K	GU10	220-240	DIMM.	97	0,244
HIGH OUTPUT										
21782	14	1460/13140	1360	15°	2700°K	GU10	220-240	DIMM.	90	0,244
21783	14	1460/7300	1360	24°	2700°K	GU10	220-240	DIMM.	90	0,244
21784	14	1460/3650	1360	36°	2700°K	GU10	220-240	DIMM.	90	0,244
21785	14	1510/13590	1400	15°	3000°K	GU10	220-240	DIMM.	90	0,244
21786	14	1510/7550	1400	24°	3000°K	GU10	220-240	DIMM.	90	0,244
21787	14	1510/3780	1400	36°	3000°K	GU10	220-240	DIMM.	90	0,244
21788	14	1620/14580	1510	15°	4000°K	GU10	220-240	DIMM.	90	0,244
21789	14	1620/8100	1510	24°	4000°K	GU10	220-240	DIMM.	90	0,244
21790	14	1620/4050	1510	36°	4000°K	GU10	220-240	DIMM.	90	0,244

DISEGNI TECNICI TECHNICAL DRAWING

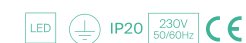
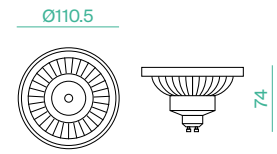

QR18LED

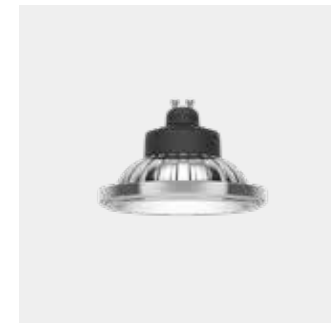

LED EPISTAR
PF 0,90
SDCM 3

Dimmer compatibili pag. 342
Compatible dimmers pag. 342

CODE	WATT	LUMEN 360°/CD	LUMEN 90°	BEAM	KELVIN	BASE	VOLT	MODE	CRI	KG
21698	18	1500/10298	1320	12°	2700°K	GU10	220-240	DIMM.	97	0,170
21700	18	1550/10813	1350	12°	3000°K	GU10	220-240	DIMM.	97	0,170
21702	18	1600/11353	1400	12°	4000°K	GU10	220-240	DIMM.	97	0,170
21699	18	1550/3947	1350	30°	2700°K	GU10	220-240	DIMM.	97	0,170
21701	18	1600/4145	1400	30°	3000°K	GU10	220-240	DIMM.	97	0,170
21703	18	1650/4352	1450	30°	4000°K	GU10	220-240	DIMM.	97	0,170

DISEGNI TECNICI TECHNICAL DRAWING

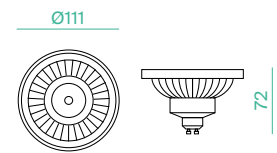

Unico



Proiettore orientabile per lampade LED DICRO e AR111
 Corpo in alluminio verniciato
 Montaggio a binario
 Lampadina non inclusa

*Adjustable tracklight for LED DICRO & AR111 bulbs
 Painted aluminium body
 Track mounting
 Bulb not included*

UNICO DICRO TRACK

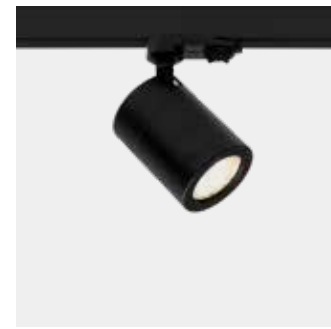

Lampadina esclusa / Bulb not included

CODE	FINISHING	BASE	VOLT	KG
40758	Bianco/White	GU10	230V 50/60HZ	0,30
40759	Nero/Black	GU10	230V 50/60HZ	0,30

INSTALLAZIONE APPLICATION



Binario/Track

DISEGNI TECNICI TECHNICAL DRAWINGS

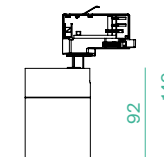

Ø 68

REGOLAZIONI ADJUSTABILITY



UNICO AR111 TRACK

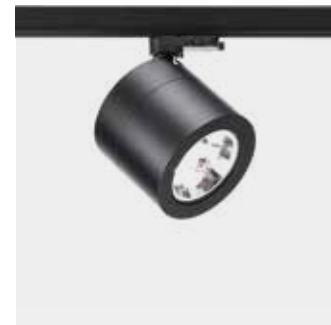

Lampadina esclusa / Bulb not included

CODE	FINISHING	BASE	VOLT	KG
40754	Bianco/White	GU10	230V 50/60HZ	0,50
40755	Nero/Black	GU10	230V 50/60HZ	0,50

INSTALLAZIONE APPLICATION

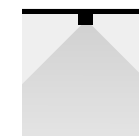

Binario/Track

DISEGNI TECNICI TECHNICAL DRAWINGS

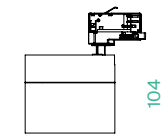

Ø 120

REGOLAZIONI ADJUSTABILITY



Sospensioni Track



Sospensioni LED integrato per binario
Materiali alluminio e vetro
Driver integrato

*Integrated LED suspensions for track
Materials: aluminum and glass
Integrated driver*

CILINDRO TRACK



LED CREE
CRI >90
PF >0.5
SDCM <3

CODE	FINISHING	WATT	LUMEN	WATT LIGHT SOURCE	LUMEN LIGHT SOURCE	BEAM	KELVIN	KG
41927	Nero/Black	10W	749	8W	900	36°	3000K	0,40
41928	Bianco/White	10W	749	8W	900	36°	3000K	0,40

INSTALLAZIONE APPLICATION

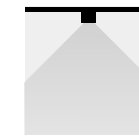

Binario/Track

DISEGNI TECNICI TECHNICAL DRAWINGS

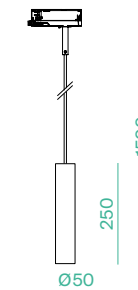

GLOBO TRACK



LED CREE
CRI >90
PF >0.5
SDCM <3

CODE	FINISHING	WATT	LUMEN	WATT LIGHT SOURCE	LUMEN LIGHT SOURCE	BEAM	KELVIN	KG
41923	Nero/Black	10W	680	8W	1105	Diff.	3000K	0,45
41924	Bianco/White	10W	680	8W	1105	Diff.	3000K	0,45

INSTALLAZIONE APPLICATION

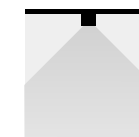

Binario/Track

DISEGNI TECNICI TECHNICAL DRAWINGS

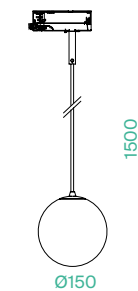

LOGICA

BELL TRACK



LED CREE
CRI >90
PF >0.5
SDCM <3

CODE	FINISHING	WATT	LUMEN	WATT LIGHT SOURCE	LUMEN LIGHT SOURCE	BEAM	KELVIN	KG
41925	Nero/Black	10W	415	8W	900	65°	3000K	0,40
41926	Bianco/White	10W	571	8W	900	65°	3000K	0,40

INSTALLAZIONE APPLICATION

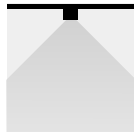

Binario/Track

DISEGNI TECNICI TECHNICAL DRAWINGS

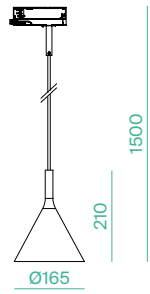

Invisibile In-Track



INVISIBLE IN-TRACK



LED SEOUL
CRI >90
PF >0.95
SDCM <6
UGR <19

CODE	FINISHING	WATT	LUMEN	WATT LIGHT SOURCE	LUMEN LIGHT SOURCE	BEAM	KELVIN	KG
60147	Bianco/White	20W	2400	16,8W	2700	48°	3000K	0,25
60148	Nero/Black	20W	2400	16,8W	2700	48°	3000K	0,25
60149	Bianco/White	20W	2500	16,8W	2800	48°	4000K	0,25
60150	Nero/Black	20W	2500	16,8W	2800	48°	4000K	0,25
60151	Bianco/White	30W	3600	25W	4200	48°	3000K	0,34
60152	Nero/Black	30W	3600	25W	4200	48°	3000K	0,34
60153	Bianco/White	30W	3700	25W	4300	48°	4000K	0,34
60154	Nero/Black	30W	3700	25W	4300	48°	4000K	0,34

INSTALLAZIONE APPLICATION

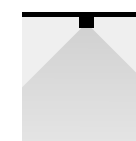

Binario/Track

DISEGNI TECNICI TECHNICAL DRAWINGS

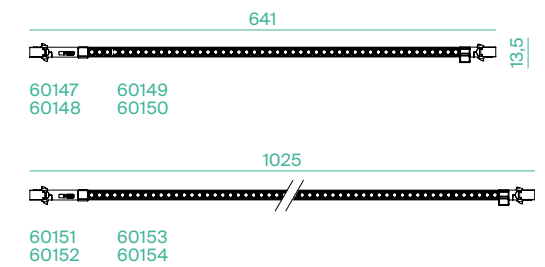

Apparecchio lineare puntiforme per installazione in binario trifase
Le sue dimensioni ridottissime gli consentono di rimanere a filo del binario,
ideale per essere integrato con i proiettori in qualsiasi progetto track.

Linear pinpoint fitting for installation in standard 3-phase track.
Its very compact dimensions allow it to remain completely recessed within the track,
ideal to be combined with spotlights in several lighting solutions.

Streamlight



Apparecchio Led integrato per binario
Corpo in alluminio estruso verniciato
Ottica asimmetrica per "wall washer"
Ottica simmetrica per illuminazione generale Driver incorporato

*Built-in LED track fitting
Painted die-cast aluminium body
Asymmetric reflector for "wall washer" effect
Symmetric reflector for general lighting Built-in driver*

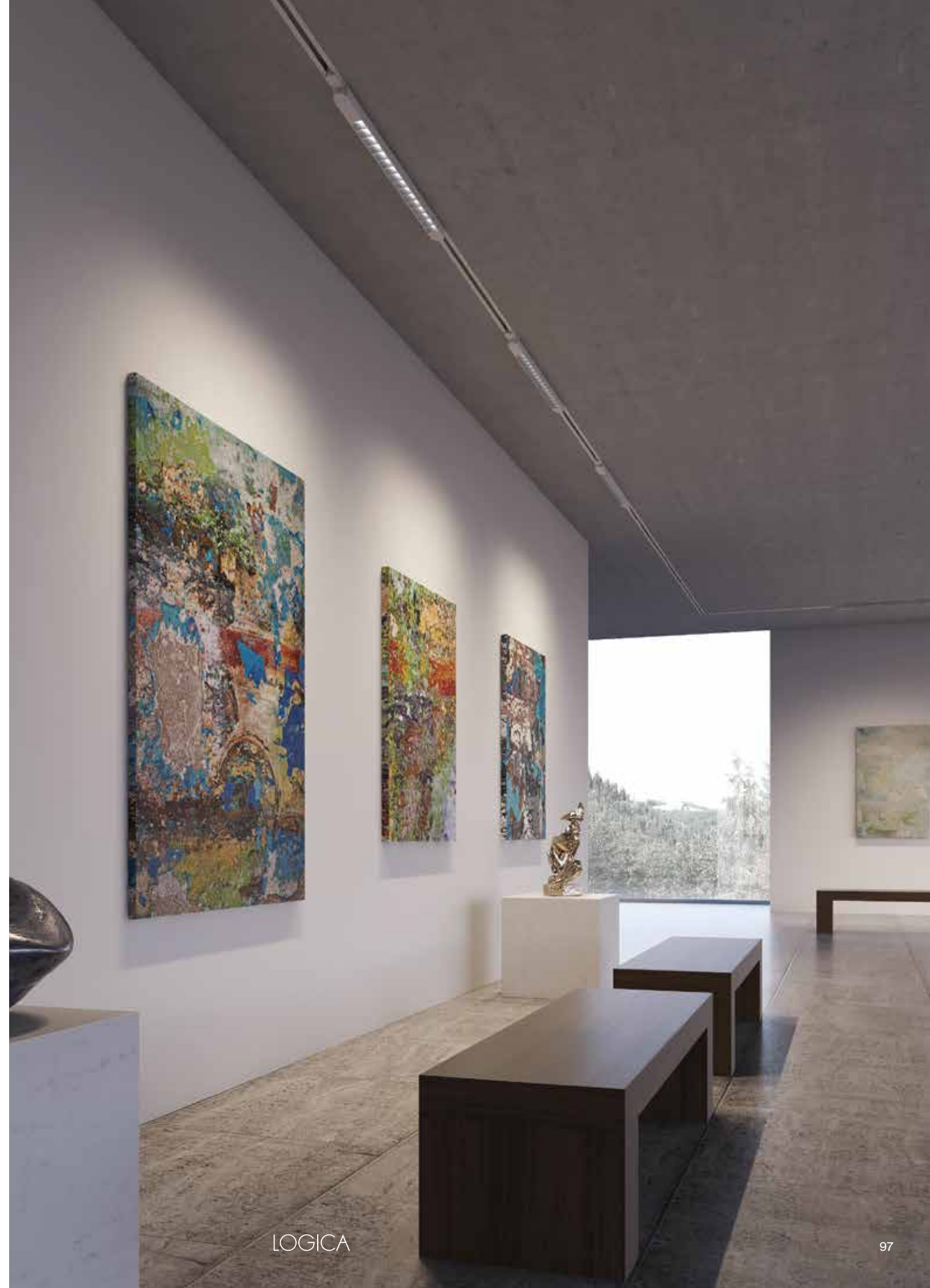

STREAMLIGHT



LED SAMSUNG
CRI >82
PF 0,9

CODE	MODEL	FINISHING	WATT	LUMEN	WATT LIGHT SOURCE	LUMEN LIGHT SOURCE	BEAM	KELVIN	KG
41094	Asymmetric A	Bianco/White	55W	5300	47W	6625	25°	3000K	1,00
41095	Asymmetric A	Bianco/White	55W	5700	47W	7125	25°	4000K	1,00
41098	Asymmetric A	Nero/Black	55W	5300	47W	6625	25°	3000K	1,00
41099	Asymmetric A	Nero/Black	55W	5700	47W	7125	25°	4000K	1,00
41096	Asymmetric B	Bianco/White	55W	5300	47W	6625	25°	3000K	1,00
41097	Asymmetric B	Bianco/White	55W	5700	47W	7125	25°	4000K	1,00
41100	Asymmetric B	Nero/Black	55W	5300	47W	6625	25°	3000K	1,00
41101	Asymmetric B	Nero/Black	55W	5700	47W	7125	25°	4000K	1,00
41102	Symmetric	Bianco/White	55W	5300	47W	6625	85°*85°	3000K	1,00
41103	Symmetric	Bianco/White	55W	5700	47W	7125	85°*85°	4000K	1,00
41104	Symmetric	Nero/Black	55W	5300	47W	6625	85°*85°	3000K	1,00
41105	Symmetric	Nero/Black	55W	5700	47W	7125	85°*85°	4000K	1,00

INSTALLAZIONE APPLICATION

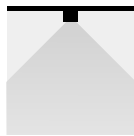

Binario/Track

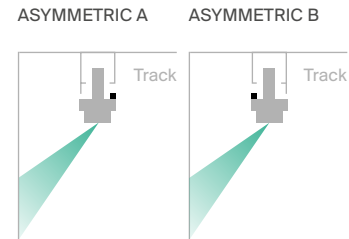

DISEGNI TECNICI TECHNICAL DRAWINGS

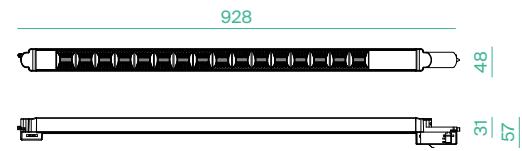

Tracks



TRACKS

CODE	FINISHING	DESCRIPTION	KG
60037	Nero/Black	Euro-track binario/track 1 mt.	0,90
60040	Nero/Black	Euro-track binario/track 2 mt.	1,80
60043	Nero/Black	Euro-track binario/track 3 mt.	2,70
60038	Bianco/White	Euro-track binario/track 1 mt.	0,90
60041	Bianco/White	Euro-track binario/track 2 mt.	1,80
60044	Bianco/White	Euro-track binario/track 3 mt.	2,70

INSTALLAZIONE APPLICATION



Soffitto/Ceiling

DISEGNI TECNICI TECHNICAL DRAWINGS

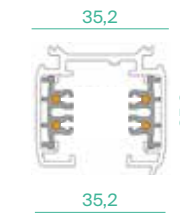

TRACKS INCASSO

CODE	FINISHING	DESCRIPTION	KG
60100	Nero/Black	Euro-track binario incasso/ Recessed track 2 mt.	2,00
60102	Nero/Black	Euro-track binario incasso/ Recessed track 3 mt.	3,00
60101	Bianco/White	Euro-track binario incasso/ Recessed track 2 mt.	2,00
60103	Bianco/White	Euro-track binario incasso/ Recessed track 3 mt.	3,00

INSTALLAZIONE APPLICATION

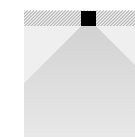

Incasso/Recessed

DISEGNI TECNICI TECHNICAL DRAWINGS

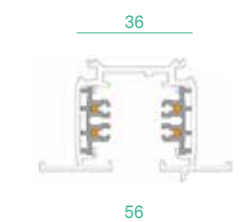

LOGICA

ACCESSORI
ACCESSORIES

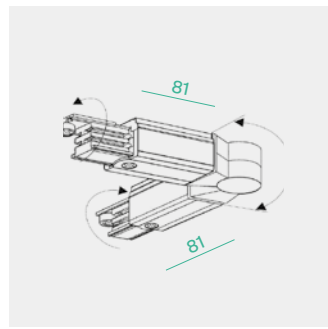

60046 - 60047

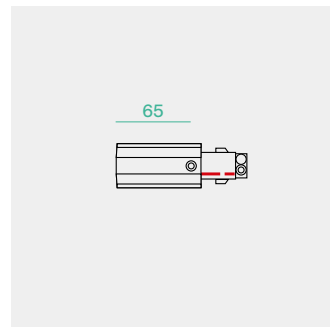

60049 - 60050

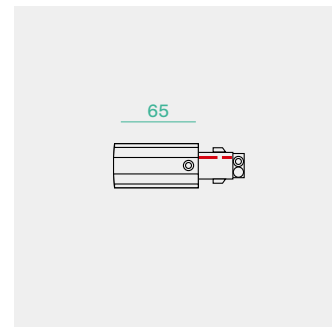

60052 - 60053

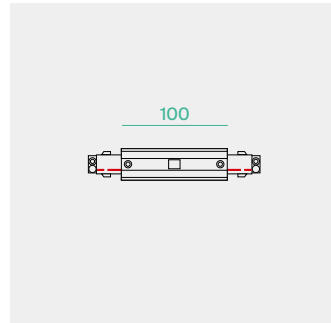

60084 - 60085

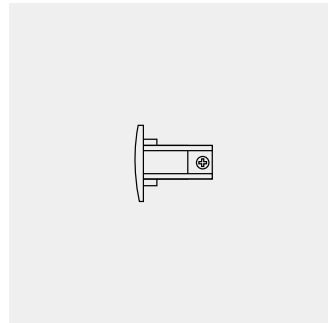

60055 - 60056



60088 - 60089

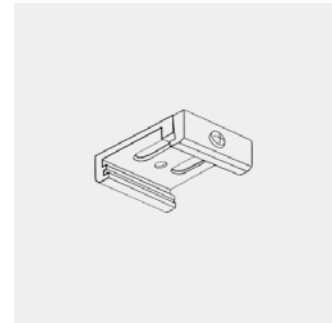

60086 - 60087

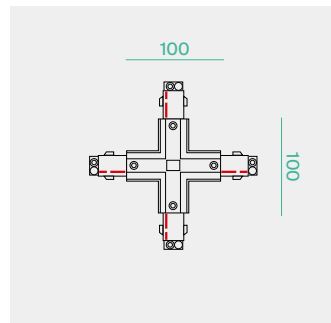

60079 - 60080

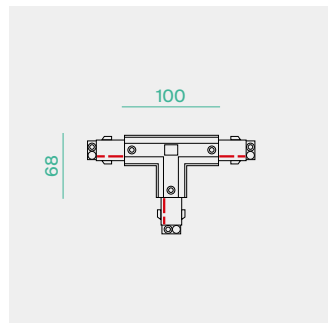

60067 - 60068

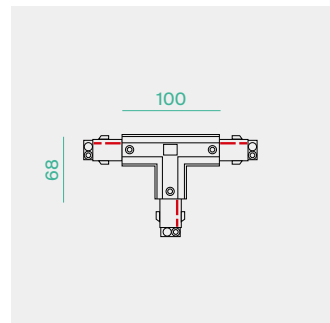

60070 - 60071

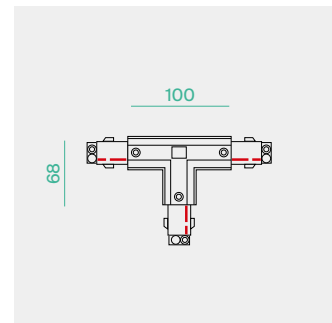

60073 - 60074

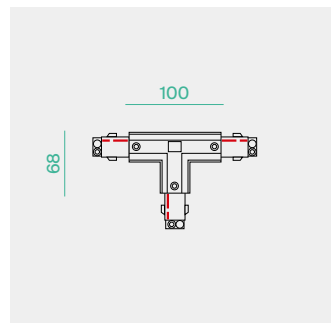

60076 - 60077

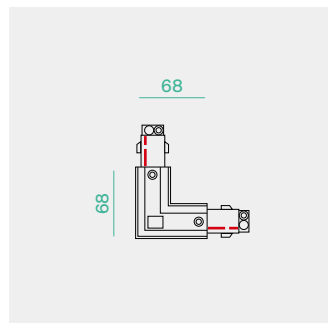

60061 - 60062

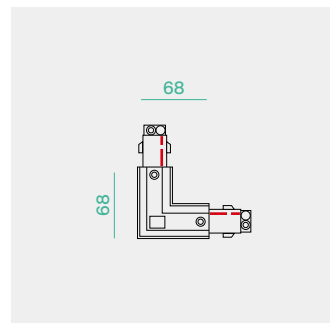

60064 - 60065

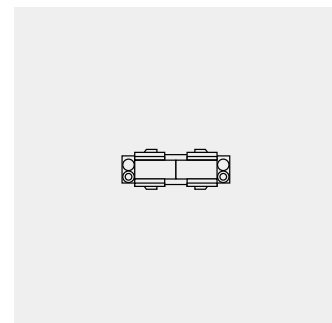

60058 - 60059

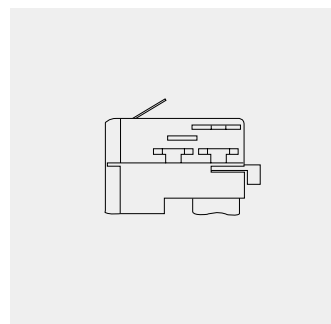

52582/N - 52582/B



11620 - 11621

ACCESSORI
ACCESSORIES

CODE	FINISHING	DESCRIPTION
60046	Nero/Black	Curva regolabile/Adjustable junction
60047	Bianco/White	Curva regolabile/Adjustable junction
60049	Nero/Black	Alimentazione sinistra/Left feed
60050	Bianco/White	Alimentazione sinistra/Left feed
60052	Nero/Black	Alimentazione destra/Right feed
60053	Bianco/White	Alimentazione destra/Right feed
60084	Nero/Black	Alimentazione centrale/Middle feed
60085	Bianco/White	Alimentazione centrale/Middle feed
60055	Nero/Black	Testata di chiusura/End-cap
60056	Bianco/White	Testata di chiusura/End-cap
60088	Nero/Black	Kit sospensione con cavo 2 mt./Suspension kit with cable 2 mt.
60089	Bianco/White	Kit sospensione con cavo 2 mt./Suspension kit with cable 2 mt.
60086	Nero/Black	Staffa soffitto/Ceiling bracket
60087	Bianco/White	Staffa soffitto/Ceiling bracket
60079	Nero/Black	Giunto "+" connector
60080	Bianco/White	Giunto "+" connector
60067	Nero/Black	Giunto-1 "T"/"T"connector-1
60068	Bianco/White	Giunto-1 "T"/"T"connector-1
60070	Nero/Black	Giunto-2 "T"/"T"connector-2
60071	Bianco/White	Giunto-2 "T"/"T"connector-2
60073	Nero/Black	Giunto-3 "T"/"T"connector-3
60074	Bianco/White	Giunto-3 "T"/"T"connector-3
60076	Nero/Black	Giunto-4 "T"/"T"connector-4
60077	Bianco/White	Giunto-4 "T"/"T"connector-4
60061	Nero/Black	Giunto-1 "L"/"L"connector-1
60062	Bianco/White	Giunto-1 "L"/"L"connector-1
60064	Nero/Black	Giunto-2 "L"/"L"connector-2
60065	Bianco/White	Giunto-2 "L"/"L"connector-2
60058	Nero/Black	Congiunzione/ straight connector
60059	Bianco/White	Congiunzione/ straight connector
52582/N	Nero/Black	Adattatore binario/track adaptor
52582/B	Bianco/White	Adattatore binario/track adaptor
11621	Nero/Black	Accessorio soffitto per Euro-track / Euro-track ceiling accessory
11620	Bianco/White	Accessorio soffitto per Euro-track / Euro-track ceiling accessory

ACCESSORI ACCESSORIES

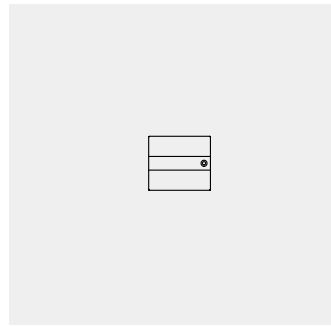

60104 - 60105

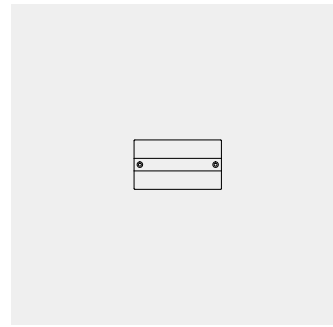

60106 - 60107

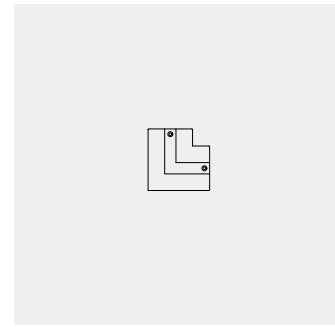

60108 - 60109

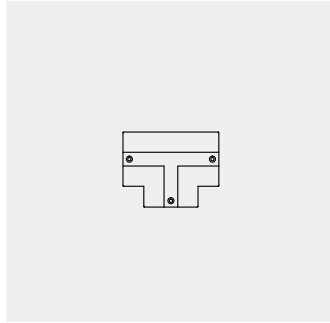

60110 - 60111

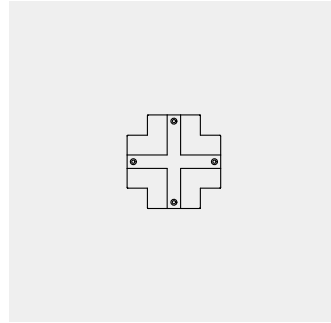

60112 - 60113

CODE	FINISHING	DESCRIPTION
60104	Nero/Black	Copertura alim. sx/dx binario incasso/ Right/left feed cover
60105	Bianco/White	Copertura alim. sx/dx binario incasso/ Right/left feed cover
60106	Nero/Black	Copertura alim. centrale binario incasso/ Middle feed cover
60107	Bianco/White	Copertura alim. centrale binario incasso/ Middle feed cover
60108	Nero/Black	Copertura giunto "L" binario incasso/ "L" connector cover
60109	Bianco/White	Copertura giunto "L" binario incasso/ "L" connector cover
60110	Nero/Black	Copertura giunto "T" binario incasso/ "T" connector cover
60111	Bianco/White	Copertura giunto "T" binario incasso/ "T" connector cover
60112	Nero/Black	Copertura giunto "+" binario incasso/ "+" connector cover
60113	Bianco/White	Copertura giunto "+" binario incasso/ "+" connector cover

EMERGENZA

Lampada emergenza 3W
per binari Autonomia 3 H
Emergency track lamp 3W
3 Hours autonomy



CODE	FINISHING	WATT	LUMEN	KELVIN	BEAM	KG
60114	Nero/Black	3	150	3000K	30°	0,15
60115	Bianco/White	3	150	3000K	30°	0,15

INSTALLAZIONE
APPLICATION

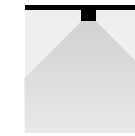

Binario/Track

DISEGNI TECNICI
TECHNICAL DRAWINGS

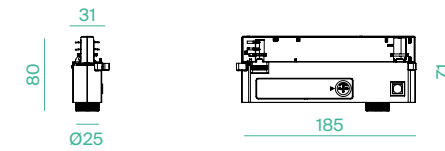

ACCESSORI ACCESSORIES

CODE	DESCRIPTION
60116	Batteria Litio 18650 3,7V 2600mAH per cod.60114/60115 / Lithium battery 18650 3,7V 2600mAH for cod.60114/60115



DOWNLIGHTS



Dot



Incasso filo realizzato
in alluminio pressofuso

*Flush recessed fixture
with die-cast aluminium body*

DOT_30

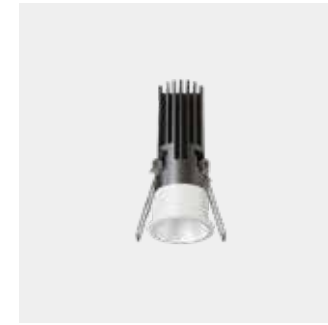

LED SMD
CRI >90
PF 0,5
SDCM ≥3

CODE	FINISHING	WATT	LUMEN	WATT LIGHT SOURCE	LUMEN LIGHT SOURCE	BEAM	KELVIN	DRIVER	KG
72043	Bianco/White	6W	365	4,5W	460	30°	2700K	9V/500mA	0,09
72044	Nero/Black	6W	365	4,5W	460	30°	2700K	9V/500mA	0,09
72045	Royal Gold	6W	365	4,5W	460	30°	2700K	9V/500mA	0,09
72046	Vintage Brass	6W	365	4,5W	460	30°	2700K	9V/500mA	0,09
72047	Bianco/White	6W	375	4,5W	480	30°	3000K	9V/500mA	0,09
72048	Nero/Black	6W	375	4,5W	480	30°	3000K	9V/500mA	0,09
72049	Royal Gold	6W	375	4,5W	480	30°	3000K	9V/500mA	0,09
72050	Vintage Brass	6W	375	4,5W	480	30°	3000K	9V/500mA	0,09

INSTALLAZIONE APPLICATION

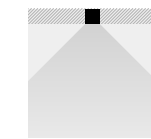

Incasso/Recessed

DISEGNI TECNICI TECHNICAL DRAWING

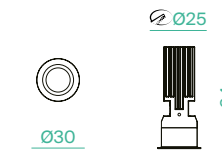

Il design minimale, le dimensioni ridotte e l'ampia gamma di finiture disponibili permettono di inserirlo in qualsiasi tipo di contesto.

The minimal design, the compact dimensions along with the wide range of available finishings allow it to be integrated into any type of lighting solution.



DRIVER

CODE	VOLT	CURRENT	SIZE	MODE
72037	5-12V	500mA	84x20,5x16,5	ON/OFF
72040	2-12V	500mA	84x20x20	DIMM.

LOGICA

DOT_40



LED V4HD GEN8
CRI >90
PF 0,5
SDCM ≥3

CODE	FINISHING	WATT	LUMEN	WATT LIGHT SOURCE	LUMEN LIGHT SOURCE	BEAM	KELVIN	DRIVER	KG
72051	Bianco/White	9W	550	7,5W	775	30°	2700K	36V/200mA	0,14
72052	Nero/Black	9W	550	7,5W	775	30°	2700K	36V/200mA	0,14
72053	Royal Gold	9W	550	7,5W	775	30°	2700K	36V/200mA	0,14
72054	Vintage Brass	9W	550	7,5W	775	30°	2700K	36V/200mA	0,14
72055	Bianco/White	9W	550	7,5W	775	40°	2700K	36V/200mA	0,14
72056	Nero/Black	9W	550	7,5W	775	40°	2700K	36V/200mA	0,14
72057	Royal Gold	9W	550	7,5W	775	40°	2700K	36V/200mA	0,14
72058	Vintage Brass	9W	550	7,5W	775	40°	2700K	36V/200mA	0,14
72059	Bianco/White	9W	590	7,5W	850	30°	3000K	36V/200mA	0,14
72060	Nero/Black	9W	590	7,5W	850	30°	3000K	36V/200mA	0,14
72061	Royal Gold	9W	590	7,5W	850	30°	3000K	36V/200mA	0,14
72062	Vintage Brass	9W	590	7,5W	850	30°	3000K	36V/200mA	0,14
72063	Bianco/White	9W	590	7,5W	850	40°	3000K	36V/200mA	0,14
72064	Nero/Black	9W	590	7,5W	850	40°	3000K	36V/200mA	0,14
72065	Royal Gold	9W	590	7,5W	850	40°	3000K	36V/200mA	0,14
72066	Vintage Brass	9W	590	7,5W	850	40°	3000K	36V/200mA	0,14

INSTALLAZIONE APPLICATION

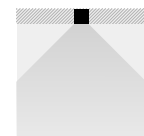

Incasso/Recessed

DISEGNI TECNICI TECHNICAL DRAWING

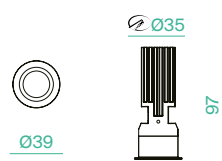

DRIVER

CODE	VOLT	CURRENT	SIZE	MODE
72038	27-40V	200mA	84X20,5X16,5	ON/OFF
72041	9-42V	200mA	110x29,6x22,6	DIMM.

DOT_50

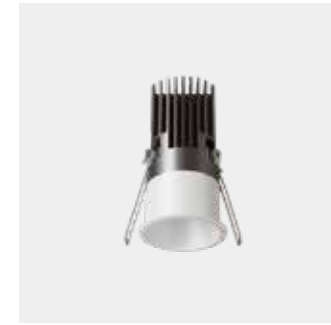

LED V6HD GEN8
CRI >90
PF 0,5
SDCM ≥3

CODE	FINISHING	WATT	LUMEN	WATT LIGHT SOURCE	LUMEN LIGHT SOURCE	BEAM	KELVIN	DRIVER	KG
72067	Bianco/White	12W	935	10,7W	1280	30°	2700K	36V/300mA	0,22
72068	Nero/Black	12W	935	10,7W	1280	30°	2700K	36V/300mA	0,22
72069	Royal Gold	12W	935	10,7W	1280	30°	2700K	36V/300mA	0,22
72070	Vintage Brass	12W	935	10,7W	1280	30°	2700K	36V/300mA	0,22
72071	Bianco/White	12W	935	10,7W	1280	55°	2700K	36V/300mA	0,22
72072	Nero/Black	12W	935	10,7W	1280	55°	2700K	36V/300mA	0,22
72073	Royal Gold	12W	935	10,7W	1280	55°	2700K	36V/300mA	0,22
72074	Vintage Brass	12W	935	10,7W	1280	55°	2700K	36V/300mA	0,22
72075	Bianco/White	12W	965	10,7W	1305	30°	3000K	36V/300mA	0,22
72076	Nero/Black	12W	965	10,7W	1305	30°	3000K	36V/300mA	0,22
72077	Royal Gold	12W	965	10,7W	1305	30°	3000K	36V/300mA	0,22
72078	Vintage Brass	12W	965	10,7W	1305	30°	3000K	36V/300mA	0,22
72079	Bianco/White	12W	965	10,7W	1305	55°	3000K	36V/300mA	0,22
72080	Nero/Black	12W	965	10,7W	1305	55°	3000K	36V/300mA	0,22
72081	Royal Gold	12W	965	10,7W	1305	55°	3000K	36V/300mA	0,22
72082	Vintage Brass	12W	965	10,7W	1305	55°	3000K	36V/300mA	0,22

INSTALLAZIONE APPLICATION

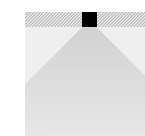

Incasso/Recessed

DISEGNI TECNICI TECHNICAL DRAWING

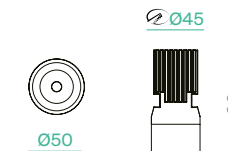

DRIVER

CODE	VOLT	CURRENT	SIZE	MODE
72039	24-42V	300mA	100x38,2x20	ON/OFF
72042	9-40V	300mA	150,5x42,5x28,5	DIMM.

Deep_Evo + Deep_Evo_Less Extr.

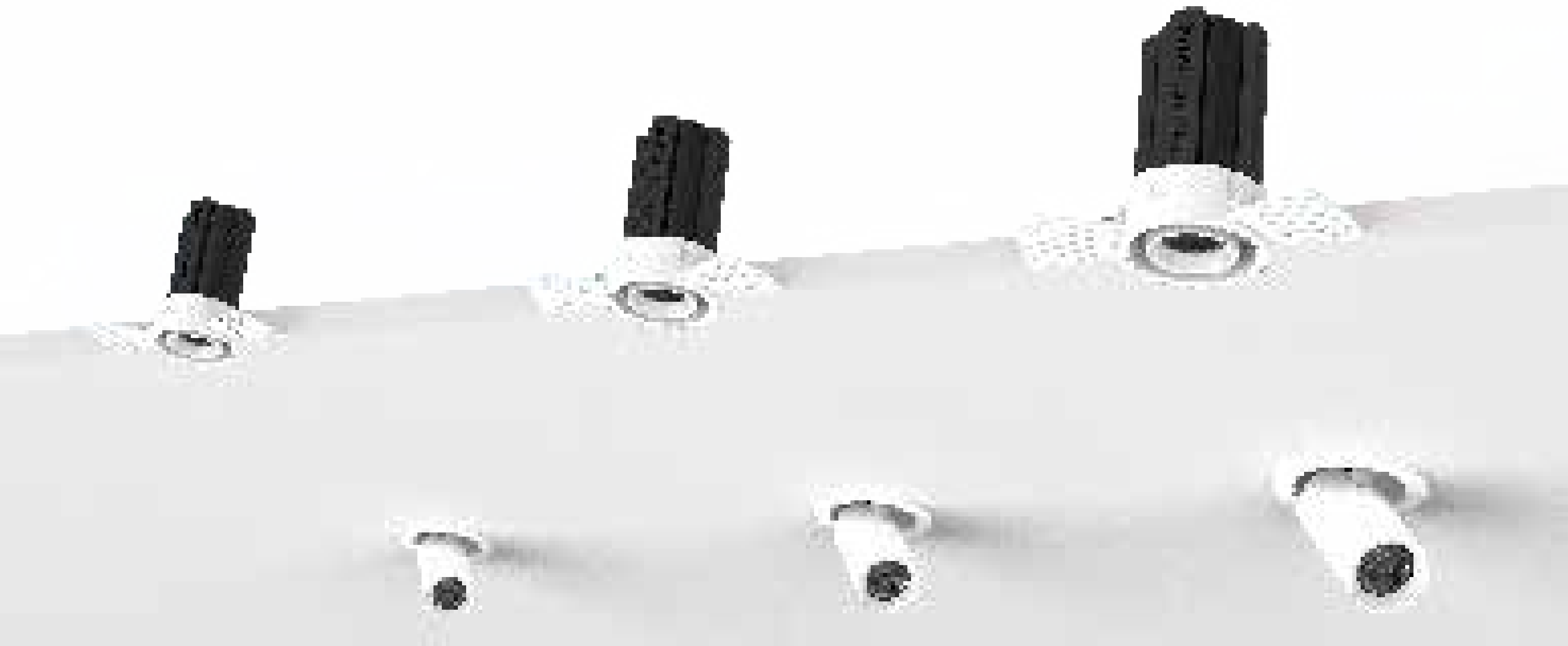

Famiglia di incassi estraibili e girevoli realizzati in alluminio pressofuso.
Estremamente versatili grazie alle differenti potenze, angoli di luce e opzioni di installazione
permettono di ottenere una illuminazione efficace e puntuale.

Family of extractable and swiveling recessed lights made of die-cast aluminum.
Extremely versatile due to different powers, beams and installation options,
the range allows effective and precise lighting

DEEP_EVO EXTR. 9W



LED V6HD
CRI 90
PF 0,56
SDCM <3
UGR <20

CODE	FINISHING	WATT	LUMEN	WATT LIGHT SOURCE	LUMEN LIGHT SOURCE	BEAM	KELVIN	DRIVER	MODE	KG
71794	Bianco/White	9	645	7	835	15°	3000K	30-42V 200mA	ON-OFF	0,20
71795	Bianco/White	9	680	7	835	24°	3000K	30-42V 200mA	ON-OFF	0,20
71796	Bianco/White	9	685	7	835	38°	3000K	30-42V 200mA	ON-OFF	0,20
71797	Bianco/White	9	675	7	835	55°	3000K	30-42V 200mA	ON-OFF	0,20
71798	Nero/Black	9	645	7	835	15°	3000K	30-42V 200mA	ON-OFF	0,20
71799	Nero/Black	9	680	7	835	24°	3000K	30-42V 200mA	ON-OFF	0,20
71800	Nero/Black	9	685	7	835	38°	3000K	30-42V 200mA	ON-OFF	0,20
71801	Nero/Black	9	675	7	835	55°	3000K	30-42V 200mA	ON-OFF	0,20
71842	Bianco/White	9	645	7	835	15°	3000K	30-42V 200mA	1-10V	0,20
71843	Bianco/White	9	680	7	835	24°	3000K	30-42V 200mA	1-10V	0,20
71844	Bianco/White	9	685	7	835	38°	3000K	30-42V 200mA	1-10V	0,20
71845	Bianco/White	9	675	7	835	55°	3000K	30-42V 200mA	1-10V	0,20
71846	Nero/Black	9	645	7	835	15°	3000K	30-42V 200mA	1-10V	0,20
71847	Nero/Black	9	680	7	835	24°	3000K	30-42V 200mA	1-10V	0,20
71848	Nero/Black	9	685	7	835	38°	3000K	30-42V 200mA	1-10V	0,20
71849	Nero/Black	9	675	7	835	55°	3000K	30-42V 200mA	1-10V	0,20
71890	Bianco/White	9	675	7	835	15°	3000K	30-42V 200mA	DALI-PUSH	0,20
71891	Bianco/White	9	675	7	835	24°	3000K	30-42V 200mA	DALI-PUSH	0,20
71892	Bianco/White	9	675	7	835	38°	3000K	30-42V 200mA	DALI-PUSH	0,20
71893	Bianco/White	9	675	7	835	55°	3000K	30-42V 200mA	DALI-PUSH	0,20
71894	Nero/Black	9	675	7	835	15°	3000K	30-42V 200mA	DALI-PUSH	0,20
71895	Nero/Black	9	675	7	835	24°	3000K	30-42V 200mA	DALI-PUSH	0,20
71896	Nero/Black	9	675	7	835	38°	3000K	30-42V 200mA	DALI-PUSH	0,20
71897	Nero/Black	9	675	7	835	55°	3000K	30-42V 200mA	DALI-PUSH	0,20

INSTALLAZIONE APPLICATION

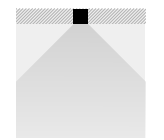

Incasso/Recessed

DISEGNI TECNICI TECHNICAL DRAWINGS

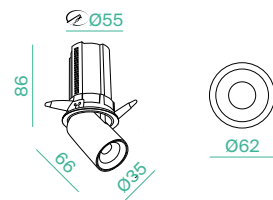

REGOLAZIONI ADJUSTABILITY



DEEP_EVO_LESS EXTR. 9W



LED V6HD
CRI 90
PF 0,56
SDCM <3
UGR <23

CODE	FINISHING	WATT	LUMEN	WATT LIGHT SOURCE	LUMEN LIGHT SOURCE	BEAM	KELVIN	DRIVER	MODE	KG
71818	Bianco/White	9	645	7	835	15°	3000K	30-42V 200mA	ON-OFF	0,20
71819	Bianco/White	9	680	7	835	24°	3000K	30-42V 200mA	ON-OFF	0,20
71820	Bianco/White	9	685	7	835	38°	3000K	30-42V 200mA	ON-OFF	0,20
71821	Bianco/White	9	675	7	835	55°	3000K	30-42V 200mA	ON-OFF	0,20
71822	Nero/Black	9	645	7	835	15°	3000K	30-42V 200mA	ON-OFF	0,20
71823	Nero/Black	9	680	7	835	24°	3000K	30-42V 200mA	ON-OFF	0,20
71824	Nero/Black	9	685	7	835	38°	3000K	30-42V 200mA	ON-OFF	0,20
71825	Nero/Black	9	675	7	835	55°	3000K	30-42V 200mA	ON-OFF	0,20
71866	Bianco/White	9	645	7	835	15°	3000K	30-42V 200mA	1-10V	0,20
71867	Bianco/White	9	680	7	835	24°	3000K	30-42V 200mA	1-10V	0,20
71868	Bianco/White	9	685	7	835	38°	3000K	30-42V 200mA	1-10V	0,20
71869	Bianco/White	9	675	7	835	55°	3000K	30-42V 200mA	1-10V	0,20
71870	Nero/Black	9	645	7	835	15°	3000K	30-42V 200mA	1-10V	0,20
71871	Nero/Black	9	680	7	835	24°	3000K	30-42V 200mA	1-10V	0,20
71872	Nero/Black	9	685	7	835	38°	3000K	30-42V 200mA	1-10V	0,20
71873	Nero/Black	9	675	7	835	55°	3000K	30-42V 200mA	1-10V	0,20
71914	Bianco/White	9	675	7	835	15°	3000K	30-42V 200mA	DALI-PUSH	0,20
71915	Bianco/White	9	675	7	835	24°	3000K	30-42V 200mA	DALI-PUSH	0,20
71916	Bianco/White	9	675	7	835	38°	3000K	30-42V 200mA	DALI-PUSH	0,20
71917	Bianco/White	9	675	7	835	55°	3000K	30-42V 200mA	DALI-PUSH	0,20
71918	Nero/Black	9	675	7	835	15°	3000K	30-42V 200mA	DALI-PUSH	0,20
71919	Nero/Black	9	675	7	835	24°	3000K	30-42V 200mA	DALI-PUSH	0,20
71920	Nero/Black	9	675	7	835	38°	3000K	30-42V 200mA	DALI-PUSH	0,20
71921	Nero/Black	9	675	7	835	55°	3000K	30-42V 200mA	DALI-PUSH	0,20

INSTALLAZIONE APPLICATION

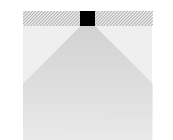

Incasso/Recessed

DISEGNI TECNICI TECHNICAL DRAWINGS

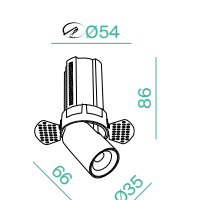

REGOLAZIONI ADJUSTABILITY



DEEP_EVO EXTR. 12W



LED V6HD
CRI 90
PF 0,94
SDCM <3
UGR <20

CODE	FINISHING	WATT	LUMEN	WATT LIGHT SOURCE	LUMEN LIGHT SOURCE	BEAM	KELVIN	DRIVER	MODE	KG
71802	Bianco/White	12	940	10,8	1151	15°	3000K	30-42V 300mA	ON-OFF	0,32
71803	Bianco/White	12	1040	10,8	1151	24°	3000K	30-42V 300mA	ON-OFF	0,32
71804	Bianco/White	12	1000	10,8	1151	38°	3000K	30-42V 300mA	ON-OFF	0,32
71805	Bianco/White	12	990	10,8	1151	55°	3000K	30-42V 300mA	ON-OFF	0,32
71806	Nero/Black	12	940	10,8	1151	15°	3000K	30-42V 300mA	ON-OFF	0,32
71807	Nero/Black	12	1040	10,8	1151	24°	3000K	30-42V 300mA	ON-OFF	0,32
71808	Nero/Black	12	1000	10,8	1151	38°	3000K	30-42V 300mA	ON-OFF	0,32
71809	Nero/Black	12	990	10,8	1151	55°	3000K	30-42V 300mA	ON-OFF	0,32
71850	Bianco/White	12	940	10,8	1151	15°	3000K	30-42V 300mA	1-10V	0,32
71851	Bianco/White	12	1040	10,8	1151	24°	3000K	30-42V 300mA	1-10V	0,32
71852	Bianco/White	12	1000	10,8	1151	38°	3000K	30-42V 300mA	1-10V	0,32
71853	Bianco/White	12	990	10,8	1151	55°	3000K	30-42V 300mA	1-10V	0,32
71854	Nero/Black	12	940	10,8	1151	15°	3000K	30-42V 300mA	1-10V	0,32
71855	Nero/Black	12	1040	10,8	1151	24°	3000K	30-42V 300mA	1-10V	0,32
71856	Nero/Black	12	1000	10,8	1151	38°	3000K	30-42V 300mA	1-10V	0,32
71857	Nero/Black	12	990	10,8	1151	55°	3000K	30-42V 300mA	1-10V	0,32
71898	Bianco/White	12	940	10,8	1151	15°	3000K	30-42V 300mA	DALI-PUSH	0,32
71899	Bianco/White	12	1040	10,8	1151	24°	3000K	30-42V 300mA	DALI-PUSH	0,32
71900	Bianco/White	12	1000	10,8	1151	38°	3000K	30-42V 300mA	DALI-PUSH	0,32
71901	Bianco/White	12	990	10,8	1151	55°	3000K	30-42V 300mA	DALI-PUSH	0,32
71902	Nero/Black	12	940	10,8	1151	15°	3000K	30-42V 300mA	DALI-PUSH	0,32
71903	Nero/Black	12	1040	10,8	1151	24°	3000K	30-42V 300mA	DALI-PUSH	0,32
71904	Nero/Black	12	1000	10,8	1151	38°	3000K	30-42V 300mA	DALI-PUSH	0,32
71905	Nero/Black	12	990	10,8	1151	55°	3000K	30-42V 300mA	DALI-PUSH	0,32

INSTALLAZIONE APPLICATION

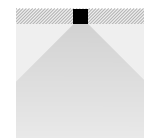

Incasso/Recessed

DISEGNI TECNICI TECHNICAL DRAWINGS

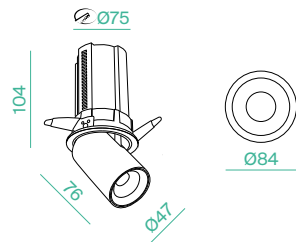

REGOLAZIONI ADJUSTABILITY



DEEP_EVO_LESS EXTR. 12W



LED V6HD
CRI 90
PF 0,94
SDCM <3
UGR <20

CODE	FINISHING	WATT	LUMEN	WATT LIGHT SOURCE	LUMEN LIGHT SOURCE	BEAM	KELVIN	DRIVER	MODE	KG
71826	Bianco/White	12	940	10,8	1151	15°	3000K	30-42V 300mA	ON-OFF	0,32
71827	Bianco/White	12	1040	10,8	1151	24°	3000K	30-42V 300mA	ON-OFF	0,32
71828	Bianco/White	12	1000	10,8	1151	38°	3000K	30-42V 300mA	ON-OFF	0,32
71829	Bianco/White	12	990	10,8	1151	55°	3000K	30-42V 300mA	ON-OFF	0,32
71830	Nero/Black	12	940	10,8	1151	15°	3000K	30-42V 300mA	ON-OFF	0,32
71831	Nero/Black	12	1040	10,8	1151	24°	3000K	30-42V 300mA	ON-OFF	0,32
71832	Nero/Black	12	1000	10,8	1151	38°	3000K	30-42V 300mA	ON-OFF	0,32
71833	Nero/Black	12	990	10,8	1151	55°	3000K	30-42V 300mA	ON-OFF	0,32
71874	Bianco/White	12	940	10,8	1151	15°	3000K	30-42V 300mA	1-10V	0,32
71875	Bianco/White	12	1040	10,8	1151	24°	3000K	30-42V 300mA	1-10V	0,32
71876	Bianco/White	12	1000	10,8	1151	38°	3000K	30-42V 300mA	1-10V	0,32
71877	Bianco/White	12	990	10,8	1151	55°	3000K	30-42V 300mA	1-10V	0,32
71878	Nero/Black	12	940	10,8	1151	15°	3000K	30-42V 300mA	1-10V	0,32
71879	Nero/Black	12	1040	10,8	1151	24°	3000K	30-42V 300mA	1-10V	0,32
71880	Nero/Black	12	1000	10,8	1151	38°	3000K	30-42V 300mA	1-10V	0,32
71881	Nero/Black	12	990	10,8	1151	55°	3000K	30-42V 300mA	1-10V	0,32
71922	Bianco/White	12	940	10,8	1151	15°	3000K	30-42V 300mA	DALI-PUSH	0,32
71923	Bianco/White	12	1040	10,8	1151	24°	3000K	30-42V 300mA	DALI-PUSH	0,32
71924	Bianco/White	12	1000	10,8	1151	38°	3000K	30-42V 300mA	DALI-PUSH	0,32
71925	Bianco/White	12	990	10,8	1151	55°	3000K	30-42V 300mA	DALI-PUSH	0,32
71926	Nero/Black	12	940	10,8	1151	15°	3000K	30-42V 300mA	DALI-PUSH	0,32
71927	Nero/Black	12	1040	10,8	1151	24°	3000K	30-42V 300mA	DALI-PUSH	0,32
71928	Nero/Black	12	1000	10,8	1151	38°	3000K	30-42V 300mA	DALI-PUSH	0,32
71929	Nero/Black	12	990	10,8	1151	55°	3000K	30-42V 300mA	DALI-PUSH	0,32

INSTALLAZIONE APPLICATION

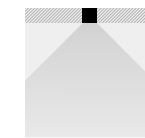

Incasso/Recessed

DISEGNI TECNICI TECHNICAL DRAWINGS

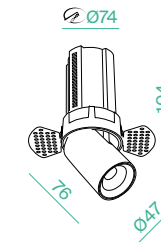

REGOLAZIONI ADJUSTABILITY



DEEP_EVO EXTR. 15W



LED V6HD
CRI 90
PF 0,95
SDCM <3
UGR <20

CODE	FINISHING	WATT	LUMEN	WATT LIGHT SOURCE	LUMEN LIGHT SOURCE	BEAM	KELVIN	DRIVER	MODE	KG
71810	Bianco/White	15	1040	12,8	1286	15°	3000K	30-42V 350mA	ON-OFF	0,62
71811	Bianco/White	15	1145	12,8	1286	24°	3000K	30-42V 350mA	ON-OFF	0,62
71812	Bianco/White	15	1099	12,8	1286	38°	3000K	30-42V 350mA	ON-OFF	0,62
71813	Bianco/White	15	1005	12,8	1286	55°	3000K	30-42V 350mA	ON-OFF	0,62
71814	Nero/Black	15	1040	12,8	1286	15°	3000K	30-42V 350mA	ON-OFF	0,62
71815	Nero/Black	15	1145	12,8	1286	24°	3000K	30-42V 350mA	ON-OFF	0,62
71816	Nero/Black	15	1099	12,8	1286	38°	3000K	30-42V 350mA	ON-OFF	0,62
71817	Nero/Black	15	1005	12,8	1286	55°	3000K	30-42V 350mA	ON-OFF	0,62
71858	Bianco/White	15	1040	12,8	1286	15°	3000K	30-42V 350mA	1-10V	0,62
71859	Bianco/White	15	1145	12,8	1286	24°	3000K	30-42V 350mA	1-10V	0,62
71860	Bianco/White	15	1099	12,8	1286	38°	3000K	30-42V 350mA	1-10V	0,62
71861	Bianco/White	15	1005	12,8	1286	55°	3000K	30-42V 350mA	1-10V	0,62
71862	Nero/Black	15	1040	12,8	1286	15°	3000K	30-42V 350mA	1-10V	0,62
71863	Nero/Black	15	1145	12,8	1286	24°	3000K	30-42V 350mA	1-10V	0,62
71864	Nero/Black	15	1099	12,8	1286	38°	3000K	30-42V 350mA	1-10V	0,62
71865	Nero/Black	15	1005	12,8	1286	55°	3000K	30-42V 350mA	1-10V	0,62
71906	Bianco/White	15	1040	12,8	1286	15°	3000K	30-42V 350mA	DALI-PUSH	0,62
71907	Bianco/White	15	1145	12,8	1286	24°	3000K	30-42V 350mA	DALI-PUSH	0,62
71908	Bianco/White	15	1099	12,8	1286	38°	3000K	30-42V 350mA	DALI-PUSH	0,62
71909	Bianco/White	15	1005	12,8	1286	55°	3000K	30-42V 350mA	DALI-PUSH	0,62
71910	Nero/Black	15	1040	12,8	1286	15°	3000K	30-42V 350mA	DALI-PUSH	0,62
71911	Nero/Black	15	1145	12,8	1286	24°	3000K	30-42V 350mA	DALI-PUSH	0,62
71912	Nero/Black	15	1099	12,8	1286	38°	3000K	30-42V 350mA	DALI-PUSH	0,62
71913	Nero/Black	15	1005	12,8	1286	55°	3000K	30-42V 350mA	DALI-PUSH	0,62

INSTALLAZIONE APPLICATION

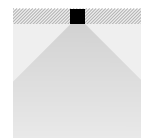

Incasso/Recessed

DISEGNI TECNICI TECHNICAL DRAWINGS

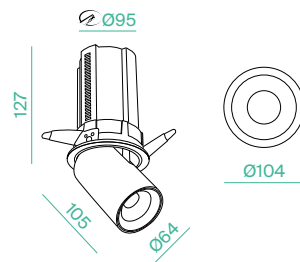

REGOLAZIONI ADJUSTABILITY



DEEP_EVO_LESS EXTR. 15W



LED V6HD
CRI 90
PF 0,96
SDCM <3
UGR <20

CODE	FINISHING	WATT	LUMEN	WATT LIGHT SOURCE	LUMEN LIGHT SOURCE	BEAM	KELVIN	DRIVER	MODE	KG
71834	Bianco/White	15	1040	12,8	1286	15°	3000K	30-42V 350mA	ON-OFF	0,62
71835	Bianco/White	15	1145	12,8	1286	24°	3000K	30-42V 350mA	ON-OFF	0,62
71836	Bianco/White	15	1099	12,8	1286	38°	3000K	30-42V 350mA	ON-OFF	0,62
71837	Bianco/White	15	1005	12,8	1286	55°	3000K	30-42V 350mA	ON-OFF	0,62
71838	Nero/Black	15	1040	12,8	1286	15°	3000K	30-42V 350mA	ON-OFF	0,62
71839	Nero/Black	15	1145	12,8	1286	24°	3000K	30-42V 350mA	ON-OFF	0,62
71840	Nero/Black	15	1099	12,8	1286	38°	3000K	30-42V 350mA	ON-OFF	0,62
71841	Nero/Black	15	1005	12,8	1286	55°	3000K	30-42V 350mA	ON-OFF	0,62
71882	Bianco/White	15	1040	12,8	1286	15°	3000K	30-42V 350mA	1-10V	0,62
71883	Bianco/White	15	1145	12,8	1286	24°	3000K	30-42V 350mA	1-10V	0,62
71884	Bianco/White	15	1099	12,8	1286	38°	3000K	30-42V 350mA	1-10V	0,62
71885	Bianco/White	15	1005	12,8	1286	55°	3000K	30-42V 350mA	1-10V	0,62
71886	Nero/Black	15	1040	12,8	1286	15°	3000K	30-42V 350mA	1-10V	0,62
71887	Nero/Black	15	1145	12,8	1286	24°	3000K	30-42V 350mA	1-10V	0,62
71888	Nero/Black	15	1099	12,8	1286	38°	3000K	30-42V 350mA	1-10V	0,62
71889	Nero/Black	15	1005	12,8	1286	55°	3000K	30-42V 350mA	1-10V	0,62
71930	Bianco/White	15	1040	12,8	1286	15°	3000K	30-42V 350mA	DALI-PUSH	0,62
71931	Bianco/White	15	1145	12,8	1286	24°	3000K	30-42V 350mA	DALI-PUSH	0,62
71932	Bianco/White	15	1099	12,8	1286	38°	3000K	30-42V 350mA	DALI-PUSH	0,62
71933	Bianco/White	15	1005	12,8	1286	55°	3000K	30-42V 350mA	DALI-PUSH	0,62
71934	Nero/Black	15	1040	12,8	1286	15°	3000K	30-42V 350mA	DALI-PUSH	0,62
71935	Nero/Black	15	1145	12,8	1286	24°	3000K	30-42V 350mA	DALI-PUSH	0,62
71936	Nero/Black	15	1099	12,8	1286	38°	3000K	30-42V 350mA	DALI-PUSH	0,62
71937	Nero/Black	15	1005	12,8	1286	55°	3000K	30-42V 350mA	DALI-PUSH	0,62

INSTALLAZIONE APPLICATION

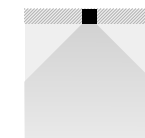

Incasso/Recessed

DISEGNI TECNICI TECHNICAL DRAWINGS

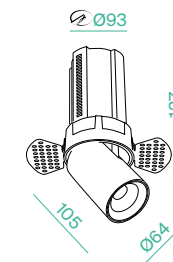

REGOLAZIONI ADJUSTABILITY



Deep_Evo

Realizzati in alluminio pressofuso, la gamma DEEP_EVO è estremamente versatile grazie alle varietà di forme, colori e opzioni di installazione. La loro struttura robusta si integra con qualsiasi ambiente, permettendo una illuminazione efficace e affidabile.

Made of die-cast aluminum, the DEEP_EVO range boasts extreme versatility with a variety of shapes, colors, and installation options. Their sturdy structure seamlessly blends into any environment, enabling effective and reliable lighting.



Funzionalità combinata Combined functionality

Grazie alla sua versatilità, puoi personalizzarlo scegliendo tra diverse opzioni di driver, montaggio, potenza, colore del riflettore e della cornice e orientabilità.

Thanks to its versatility, you can personalize your downlight picking up among the various options: driver, installation mode, power, adjustable/ fixed and various reflectors.



MODULO
MODULE



ON-OFF
DALI/PUSH
1-10V

9W
12W
15W
20W
24W

BEAM



15°
24°
38°
55°

CORPO
BODY

TRIM
Bianco/White
Nero/Black



TRIMLESS
Bianco/White



RIFLETTORE
REFLECTOR



Fisso/Fixed
Regolabile/Adjustable

Bianco/White
Nero/Black

DEEP_EVO FIX



CODE	BODY FINISHING	FINISHING REFLECTOR	MODULI	KG
71582	Bianco/White	Bianco/White	Pag. 132-133	0,12
71583	Bianco/White	Nero/Black	Pag. 132-133	0,12
71585	Nero/Black	Bianco/White	Pag. 132-133	0,12
71586	Nero/Black	Nero/Black	Pag. 132-133	0,12

DEEP_EVO ADJUSTABLE



CODE	BODY FINISHING	FINISHING REFLECTOR	MODULI	KG
71588	Bianco/White	Bianco/White	Pag. 132-133	0,12
71589	Bianco/White	Nero/Black	Pag. 132-133	0,12
71591	Nero/Black	Bianco/White	Pag. 132-133	0,12
71592	Nero/Black	Nero/Black	Pag. 132-133	0,12

REGOLAZIONI
ADJUSTABILITY



355°
25°

INSTALLAZIONE
APPLICATION

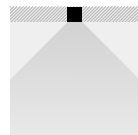

Incasso/Recessed

DISEGNI TECNICI C/ MODULO LED
TECHNICAL DRAWING W/ LED MODULE

LED Module 9W

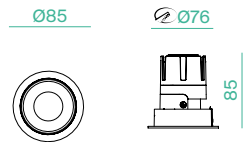

LED Module 12W-15W

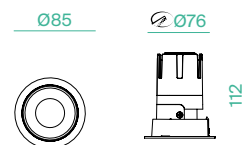

DEEP_EVO LESS FIX



CODE	BODY FINISHING	FINISHING REFLECTOR	MODULI	KG
71594	Bianco/White	Bianco/White	Pag. 132-133	0,13
71595	Bianco/White	Nero/Black	Pag. 132-133	0,13

DEEP_EVO LESS ADJUSTABLE



CODE	BODY FINISHING	FINISHING REFLECTOR	MODULI	KG
71597	Bianco/White	Bianco/White	Pag. 132-133	0,13
71598	Bianco/White	Nero/Black	Pag. 132-133	0,13

REGOLAZIONI
ADJUSTABILITY



355°
25°

INSTALLAZIONE
APPLICATION

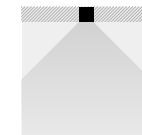

Incasso/Recessed

DISEGNI TECNICI C/ MODULO LED
TECHNICAL DRAWING W/ LED MODULE

LED Module 9W

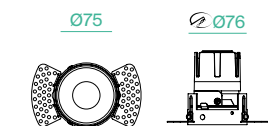

LED Module 12W-15W

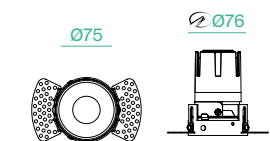

DEEP_EVO
GRANDE
FIX



CODE	BODY FINISHING	FINISHING REFLECTOR	MODULI	KG
71729	Bianco/White	Bianco/White	Pag. 132-133	0,22
71730	Bianco/White	Nero/Black	Pag. 132-133	0,22
71732	Nero/Black	Bianco/White	Pag. 132-133	0,22
71733	Nero/Black	Nero/Black	Pag. 132-133	0,22

DEEP_EVO
GRANDE
ADJUSTABLE



CODE	BODY FINISHING	FINISHING REFLECTOR	MODULI	KG
71735	Bianco/White	Bianco/White	Pag. 132-133	0,22
71736	Bianco/White	Nero/Black	Pag. 132-133	0,22
71738	Nero/Black	Bianco/White	Pag. 132-133	0,22
71739	Nero/Black	Nero/Black	Pag. 132-133	0,22

REGOLAZIONI
ADJUSTABILITY



INSTALLAZIONE
APPLICATION

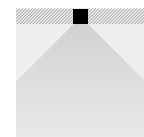

Incasso/Recessed

DISEGNI TECNICI C/ MODULO LED
TECHNICAL DRAWING W/ LED MODULE

LED Module 20W-24W

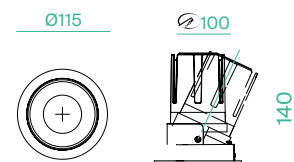

DEEP_EVO
LESS GRANDE
FIX



CODE	BODY FINISHING	FINISHING REFLECTOR	MODULI	KG
71741	Bianco/White	Bianco/White	Pag. 132-133	0,24
71742	Bianco/White	Nero/Black	Pag. 132-133	0,24

DEEP_EVO
LESS GRANDE
ADJUSTABLE



CODE	BODY FINISHING	FINISHING REFLECTOR	MODULI	KG
71744	Bianco/White	Bianco/White	Pag. 132-133	0,24
71745	Bianco/White	Nero/Black	Pag. 132-133	0,24

REGOLAZIONI
ADJUSTABILITY



INSTALLAZIONE
APPLICATION



Incasso/Recessed

DISEGNI TECNICI C/ MODULO LED
TECHNICAL DRAWING W/ LED MODULE

LED Module 20W-24W

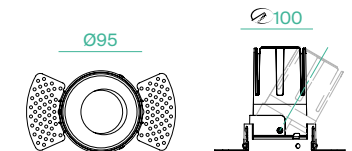

DEEP_EVO_Q FIX/ADJ



CODE	BODY FINISHING	FINISHING REFLECTOR	MODULI	KG
71705	Bianco/White	Bianco/White	Pag. 132-133	0,13
71706	Bianco/White	Nero/Black	Pag. 132-133	0,13
71708	Nero/Black	Bianco/White	Pag. 132-133	0,13
71709	Nero/Black	Nero/Black	Pag. 132-133	0,13

REGOLAZIONI
ADJUSTABILITY



INSTALLAZIONE
APPLICATION

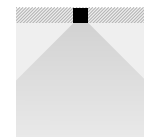

Incasso/Recessed

DISEGNI TECNICI C/ MODULO LED
TECHNICAL DRAWING W/ LED MODULE

LED Module 9W

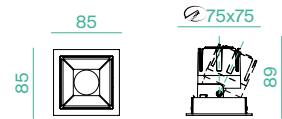

LED Module 12W-15W



DEEP_EVO LESS_Q FIX/ADJ



CODE	BODY FINISHING	FINISHING REFLECTOR	MODULI	KG
71711	Bianco/White	Bianco/White	Pag. 132-133	0,14
71712	Bianco/White	Nero/Black	Pag. 132-133	0,14

REGOLAZIONI
ADJUSTABILITY



INSTALLAZIONE
APPLICATION

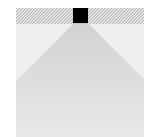

Incasso/Recessed

DISEGNI TECNICI C/ MODULO LED
TECHNICAL DRAWING W/ LED MODULE

LED Module 9W

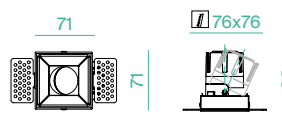

LED Module 12W-15W

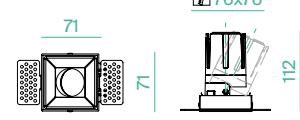

DEEP_EVO_Q GRANDE FIX/ADJ



CODE	BODY FINISHING	FINISHING REFLECTOR	MODULI	KG
71723	Bianco/White	Bianco/White	Pag. 132-133	0,24
71724	Bianco/White	Nero/Black	Pag. 132-133	0,24
71726	Nero/Black	Bianco/White	Pag. 132-133	0,24
71727	Nero/Black	Nero/Black	Pag. 132-133	0,24

REGOLAZIONI
ADJUSTABILITY



INSTALLAZIONE
APPLICATION



Incasso/Recessed

DISEGNI TECNICI C/ MODULO LED
TECHNICAL DRAWING W/ LED MODULE

LED Module 20W-24W

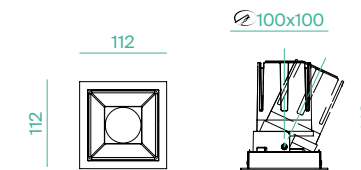

DEEP_EVO STD



CODE	BODY FINISHING	FINISHING REFLECTOR	MODULI	KG
71600	Bianco/White	Bianco/White	Pag. 132-133	0,08
71601	Bianco/White	Nero/Black	Pag. 132-133	0,08
71603	Nero/Black	Bianco/White	Pag. 132-133	0,08
71604	Nero/Black	Nero/Black	Pag. 132-133	0,08

INSTALLAZIONE
APPLICATION



Incasso/Recessed

DISEGNI TECNICI C/ MODULO LED
TECHNICAL DRAWING W/ LED MODULE

LED Module 9W

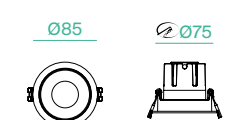

LED Module 12W-15W

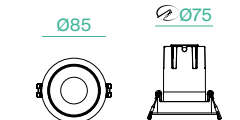

MODULO LED DEEP_EVO



LED BRIDGELUX
CRI >90
PF >0,9

CODE	WATT	LUMEN	BEAM	KELVIN	DRIVER	MODE	KG
DEEP_EVO							
71606	9W	715	15°	3000K	30-42V 200mA	ON-OFF	0,16
71607	9W	725	24°	3000K	30-42V 200mA	ON-OFF	0,16
71608	9W	710	38°	3000K	30-42V 200mA	ON-OFF	0,16
71609	9W	695	55°	3000K	30-42V 200mA	ON-OFF	0,16
71610	12W	1015	15°	3000K	30-42V 300mA	ON-OFF	0,23
71611	12W	1055	24°	3000K	30-42V 300mA	ON-OFF	0,23
71612	12W	1050	38°	3000K	30-42V 300mA	ON-OFF	0,23
71613	12W	1000	55°	3000K	30-42V 300mA	ON-OFF	0,23
71614	15W	1150	15°	3000K	30-42V 350mA	ON-OFF	0,23
71615	15W	1170	24°	3000K	30-42V 350mA	ON-OFF	0,23
71616	15W	1155	38°	3000K	30-42V 350mA	ON-OFF	0,23
71617	15W	1110	55°	3000K	30-42V 350mA	ON-OFF	0,23
DEEP_EVO GRANDE							
71747	20W	1863	15°	3000K	40V 500mA	ON-OFF	0,34
71748	20W	1948	24°	3000K	40V 500mA	ON-OFF	0,34
71749	20W	1909	38°	3000K	40V 500mA	ON-OFF	0,34
71750	20W	1873	55°	3000K	40V 500mA	ON-OFF	0,34
71751	24W	2321	15°	3000K	40V 600mA	ON-OFF	0,34
71752	24W	2314	24°	3000K	40V 600mA	ON-OFF	0,34
71753	24W	2307	38°	3000K	40V 600mA	ON-OFF	0,34
71754	24W	2301	55°	3000K	40V 600mA	ON-OFF	0,34
DEEP_EVO							
71618	9W	715	15°	3000K	30-42V 200mA	1-10V	0,16
71619	9W	725	24°	3000K	30-42V 200mA	1-10V	0,16
71620	9W	710	38°	3000K	30-42V 200mA	1-10V	0,16
71621	9W	695	55°	3000K	30-42V 200mA	1-10V	0,16
71622	12W	1015	15°	3000K	30-42V 300mA	1-10V	0,23
71623	12W	1055	24°	3000K	30-42V 300mA	1-10V	0,23
71624	12W	1050	38°	3000K	30-42V 300mA	1-10V	0,23
71625	12W	1000	55°	3000K	30-42V 300mA	1-10V	0,23
71626	15W	1150	15°	3000K	30-42V 350mA	1-10V	0,23
71627	15W	1170	24°	3000K	30-42V 350mA	1-10V	0,23

CODE	WATT	LUMEN	BEAM	KELVIN	DRIVER	MODE	KG
71628	15W	1155	38°	3000K	30-42V 350mA	1-10V	0,23
71629	15W	1110	55°	3000K	30-42V 350mA	1-10V	0,23
71763	9W	715	15°	3000K	30-42V 200mA	DALI/PUSH	0,16
71764	9W	725	24°	3000K	30-42V 200mA	DALI/PUSH	0,16
71765	9W	710	38°	3000K	30-42V 200mA	DALI/PUSH	0,16
71766	9W	695	55°	3000K	30-42V 200mA	DALI/PUSH	0,16
71767	12W	1015	15°	3000K	30-42V 300mA	DALI/PUSH	0,23
71768	12W	1055	24°	3000K	30-42V 300mA	DALI/PUSH	0,23
71769	12W	1050	38°	3000K	30-42V 300mA	DALI/PUSH	0,23
71770	12W	1000	55°	3000K	30-42V 300mA	DALI/PUSH	0,23
71771	15W	1150	15°	3000K	30-42V 350mA	DALI/PUSH	0,23
71772	15W	1170	24°	3000K	30-42V 350mA	DALI/PUSH	0,23
71773	15W	1155	38°	3000K	30-42V 350mA	DALI/PUSH	0,23
71774	15W	1110	55°	3000K	30-42V 350mA	DALI/PUSH	0,23
DEEP_EVO GRANDE							
71755	20W	1863	15°	3000K	40V 500mA	DALI/PUSH	0,34
71756	20W	1948	24°	3000K	40V 500mA	DALI/PUSH	0,34
71757	20W	1909	38°	3000K	40V 500mA	DALI/PUSH	0,34
71758	20W	1873	55°	3000K	40V 500mA	DALI/PUSH	0,34
71759	24W	2321	15°	3000K	40V 600mA	DALI/PUSH	0,34
71760	24W	2314	24°	3000K	40V 600mA	DALI/PUSH	0,34
71761	24W	2307	38°	3000K	40V 600mA	DALI/PUSH	0,34
71762	24W	2301	55°	3000K	40V 600mA	DALI/PUSH	0,34



ACCESSORI ACCESSORIES

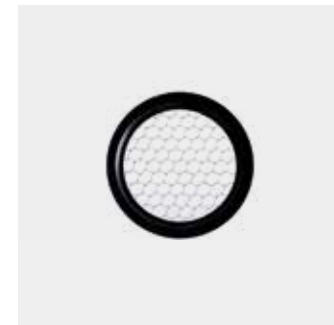

CODE	DESCRIPTION
71575	Filtro honeycomb 9W-12W-15W/Honeycomb filter 9W-12W-15W
71663	Filtro honeycomb 20W-24W/Honeycomb filter 20W-24W

DEEP_EVO_GU10 FIX



CODE	BODY FINISHING	BASE	WATT	VOLT	KG
71696	Bianco/White	GU10	Max 50W	230V 50/60Hz	0,12
71700	Nero/Black	GU10	Max 50W	230V 50/60Hz	0,12

INSTALLAZIONE APPLICATION

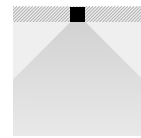

Incasso/Recessed

DISEGNI TECNICI TECHNICAL DRAWING

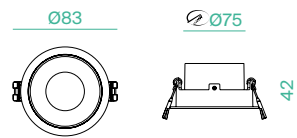

DEEP_EVO_GU10 ADJUSTABLE



CODE	BODY FINISHING	BASE	WATT	VOLT	KG
71694	Bianco/White	GU10	Max 50W	230V 50/60Hz	0,12
71695	Nero/Black	GU10	Max 50W	230V 50/60Hz	0,12

INSTALLAZIONE APPLICATION

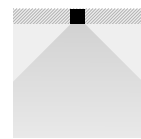

Incasso/Recessed

DISEGNI TECNICI TECHNICAL DRAWING

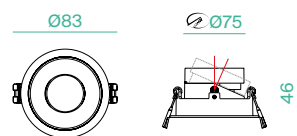

MODULE_PRECISE 50

LED BRIDGELUX
CRI >90
PF >0,8
SDCM 3



Dimmer compatibili pag. 342
Compatible dimmers pag. 342

CODE	WATT	LUMEN 360°/CD	LUMEN 90°	BEAM	KELVIN	VOLT	MODE	KG
21723	8,5W	740 / 4600	710	15°	2700K	220-240V	DIMM.	0,172
21724	8,5W	740 / 3690	710	24°	2700K	220-240V	DIMM.	0,172
21725	8,5W	740 / 1850	710	38°	2700K	220-240V	DIMM.	0,172
21726	8,5W	760 / 4750	730	15°	3000K	220-240V	DIMM.	0,172
21727	8,5W	760 / 3800	730	24°	3000K	220-240V	DIMM.	0,172
21728	8,5W	760 / 1900	730	38°	3000K	220-240V	DIMM.	0,172

DISEGNI TECNICI TECHNICAL DRAWING

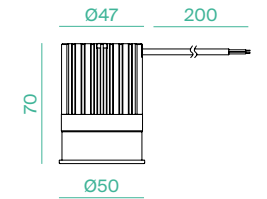

PRO+EVO REAL_COLOUR

LED BRIDGELUX
PF >0,80
SDCM 3

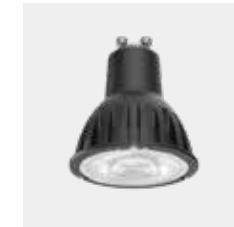

Dimmer compatibili pag. 342
Compatible dimmers pag. 342

CODE	WATT	LUMEN 360°/CD	LUMEN 90°	BEAM	KELVIN	BASE	VOLT	MODE	CRI	KG
REAL COLOUR										
21756	6,5	500/4900	480	12°	2700°K	GU10	220-240	DIMM.	97	0,060
21758	6,5	530/2120	500	25°	2700°K	GU10	220-240	DIMM.	97	0,060
21760	6,5	530/1100	500	36°	2700°K	GU10	220-240	DIMM.	97	0,060
21762	6,5	530/620	500	60°	2700°K	GU10	220-240	DIMM.	97	0,060
21757	6,5	510/5000	490	12°	3000°K	GU10	220-240	DIMM.	97	0,060
21759	6,5	540/2160	510	25°	3000°K	GU10	220-240	DIMM.	97	0,060
21761	6,5	540/1130	510	36°	3000°K	GU10	220-240	DIMM.	97	0,060
21763	6,5	540/630	510	60°	3000°K	GU10	220-240	DIMM.	97	0,060
HIGH OUTPUT										
21764	6,5	680/4080	630	15°	2700°K	GU10	220-240	DIMM.	90	0,060
21766	6,5	680/2720	630	25°	2700°K	GU10	220-240	DIMM.	90	0,060
21768	6,5	680/1360	630	36°	2700°K	GU10	220-240	DIMM.	90	0,060
21770	6,5	680/780	630	60°	2700°K	GU10	220-240	DIMM.	90	0,060
21765	6,5	700/4260	650	15°	3000°K	GU10	220-240	DIMM.	90	0,060
21767	6,5	700/2840	650	25°	3000°K	GU10	220-240	DIMM.	90	0,060
21769	6,5	700/1420	650	36°	3000°K	GU10	220-240	DIMM.	90	0,060
21771	6,5	700/820	650	60°	3000°K	GU10	220-240	DIMM.	90	0,060

DISEGNI TECNICI TECHNICAL DRAWING



DICRO_50_DTW (DIM TO WARM)

LED BRIDGELUX
CRI 97
PF 0,80
SDCM 3



Dimmer compatibili pag. 342
Compatible dimmers pag. 342

CODE	WATT	LUMEN 360°/CD	LUMEN 90°	BEAM	KELVIN	BASE	VOLT	MODE	KG
21731	6,8	520/1000	480	38°	2200-2700°K	GU10	220-240	DIMM.	0,056

DISEGNI TECNICI TECHNICAL DRAWING



DEEP_EVO AR111
GU10
ADJUSTABLE



CODE	BODY FINISHING	BASE	WATT	VOLT	KG
72083	Bianco/White	GU10	Max 50W	230V 50/60Hz	0,20
72084	Nero/Black	GU10	Max 50W	230V 50/60Hz	0,20

INSTALLAZIONE
APPLICATION

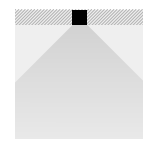

Incasso/Recessed



DISEGNI TECNICI
TECHNICAL DRAWING

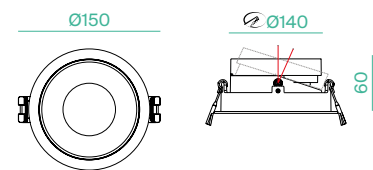

REGOLAZIONI
ADJUSTABILITY



355°
25°



QR14LED
REAL_COLOUR
HIGH_OUTPUT

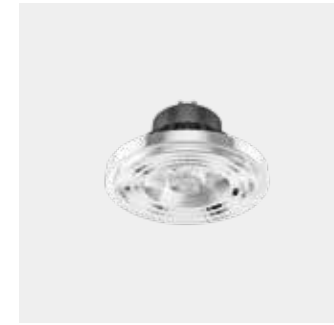

LED BRIDGELUX
PF 0,90
SDCM 3

Dimmer compatibili pag. 342
Compatible dimmers pag. 342

CODE	WATT	LUMEN 360°/CD	LUMEN 90°	BEAM	KELVIN	BASE	VOLT	MODE	CRI	KG
REAL COLOUR										
21773	14	1050/21000	1020	10°	2700°K	GU10	220-240	DIMM.	97	0,244
21774	14	1100/5500	1020	24°	2700°K	GU10	220-240	DIMM.	97	0,244
21775	14	1100/2750	1020	36°	2700°K	GU10	220-240	DIMM.	97	0,244
21776	14	1100/22000	1060	10°	3000°K	GU10	220-240	DIMM.	97	0,244
21777	14	1150/5750	1060	24°	3000°K	GU10	220-240	DIMM.	97	0,244
21778	14	1150/2875	1060	36°	3000°K	GU10	220-240	DIMM.	97	0,244
21779	14	1200/24000	1160	10°	4000°K	GU10	220-240	DIMM.	97	0,244
21780	14	1260/6300	1160	24°	4000°K	GU10	220-240	DIMM.	97	0,244
21781	14	1260/3150	1160	36°	4000°K	GU10	220-240	DIMM.	97	0,244
HIGH OUTPUT										
21782	14	1460/13140	1360	15°	2700°K	GU10	220-240	DIMM.	90	0,244
21783	14	1460/7300	1360	24°	2700°K	GU10	220-240	DIMM.	90	0,244
21784	14	1460/3650	1360	36°	2700°K	GU10	220-240	DIMM.	90	0,244
21785	14	1510/13590	1400	15°	3000°K	GU10	220-240	DIMM.	90	0,244
21786	14	1510/7550	1400	24°	3000°K	GU10	220-240	DIMM.	90	0,244
21787	14	1510/3780	1400	36°	3000°K	GU10	220-240	DIMM.	90	0,244
21788	14	1620/14580	1510	15°	4000°K	GU10	220-240	DIMM.	90	0,244
21789	14	1620/8100	1510	24°	4000°K	GU10	220-240	DIMM.	90	0,244
21790	14	1620/4050	1510	36°	4000°K	GU10	220-240	DIMM.	90	0,244

DISEGNI TECNICI
TECHNICAL DRAWING

Ø110.5

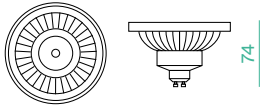

QR18LED

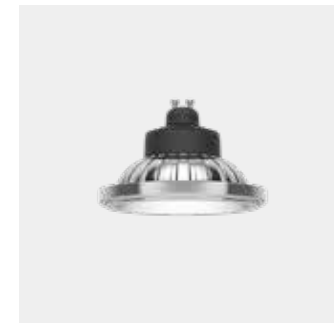

LED EPISTAR
PF 0,90
SDCM 3

Dimmer compatibili pag. 342
Compatible dimmers pag. 342

CODE	WATT	LUMEN 360°/CD	LUMEN 90°	BEAM	KELVIN	BASE	VOLT	MODE	CRI	KG
21698	18	1500/10298	1320	12°	2700°K	GU10	220-240	DIMM.	97	0,170
21700	18	1550/10813	1350	12°	3000°K	GU10	220-240	DIMM.	97	0,170
21702	18	1600/11353	1400	12°	4000°K	GU10	220-240	DIMM.	97	0,170
21699	18	1550/3947	1350	30°	2700°K	GU10	220-240	DIMM.	97	0,170
21701	18	1600/4145	1400	30°	3000°K	GU10	220-240	DIMM.	97	0,170
21703	18	1650/4352	1450	30°	4000°K	GU10	220-240	DIMM.	97	0,170

DISEGNI TECNICI
TECHNICAL DRAWING

Ø111

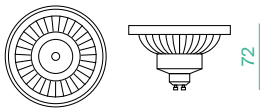

Light + Module

LIGHT+MODULE è la combinazione massima della versatilità per la illuminazione a incasso GU10. Realizzato in pressofusione di alluminio, garantisce durabilità dei materiali ed estetica minimale.

Il corpo LIGHT è disponibile in tre versioni: DICROICA 35, DICROICA 50 e QR111. Le versioni da 35 e da 50, grazie alla possibilità di integrare dei moduli LED, garantiscono anche una alta efficienza energetica.

Adattabile e innovativo, LIGHT+MODULE permettono di ottenere un connubio di funzionalità e design.

LIGHT+MODULE represents the pinnacle of versatility in GU10 recessed lighting. Crafted in die-cast aluminum, it ensures material durability and minimalist aesthetics.

The LIGHT body is available in three versions: DICROICA 35, DICROICA 50, and QR111. The 35 and 50 versions, thanks to the option to integrate LED modules, also guarantee high energy efficiency.

Adaptable and innovative, LIGHT+MODULE enables achieving a seamless blend of functionality and design.

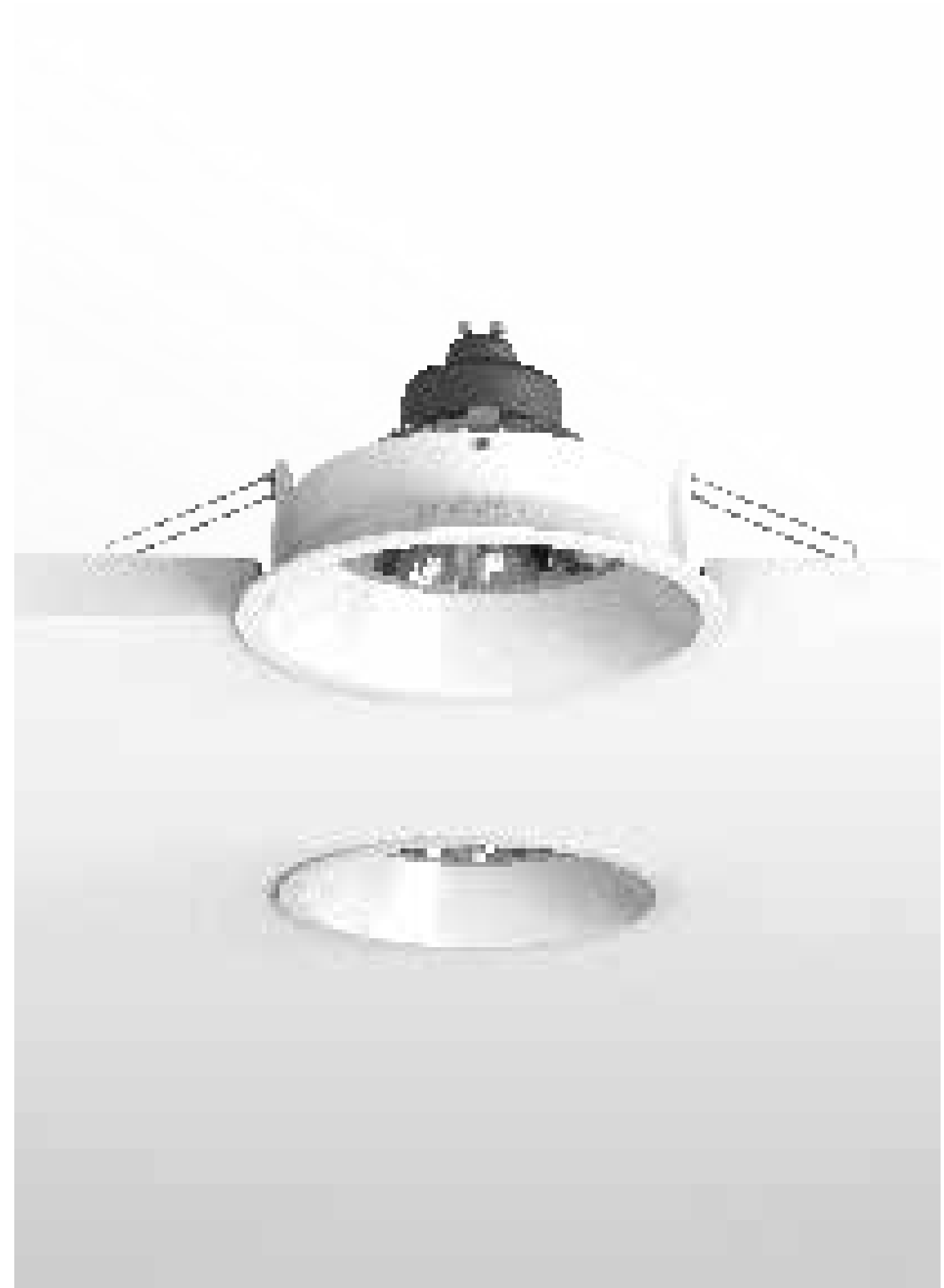

Light_35

Incasso minimale per moduli o dicroiche 35mm.
Corpo in pressofusione d'alluminio
Cablato GU10

Minimal recessed downlight for 35mm modules or MR-11 bulbs
Die-cast aluminum body
GU10 base

LIGHT SOURCE



MODULE_PRECISE
35
5.5W



DICROICA_PRECISE
35
3.5W

FINITURA CORPO BODY FINISHING



Nero/Black



Bianco/White



Oro/Gold

LIGHT_35



CODE	FINISHING	BASE	WATT	VOLT	KG
41281	Bianco/White	GU10	Max 50W	230V 50/60Hz	0,090
41282	Nero/Black	GU10	Max 50W	230V 50/60Hz	0,090
41287	Oro/Gold	GU10	Max 50W	230V 50/60Hz	0,090

INSTALLAZIONE APPLICATION

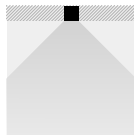

Incasso/Recessed

DISEGNI TECNICI TECHNICAL DRAWING



MODULE_PRECISE 35



LED BRIDGELUX
CRI >90
PF >0,8
SDCM 3

Dimmer compatibili pag. 342
Compatible dimmers pag. 342

CODE	WATT	LUMEN 360°/CD	LUMEN 90°	BEAM	KELVIN	VOLT	MODE	KG
21721	5,5W	470 / 1000	450	38°	2700K	220-240V	DIMM.	0,085
21722	5,5W	470 / 1000	450	38°	3000K	220-240V	DIMM.	0,085

DISEGNI TECNICI TECHNICAL DRAWING

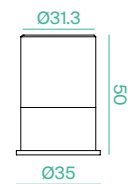

DICRO_PRECISE 35



LED BRIDGELUX
CRI 97
PF >0,90
SDCM 3

Dimmer compatibili pag. 342
Compatible dimmers pag. 342

CODE	WATT	LUMEN 360°/CD	LUMEN 90°	BEAM	KELVIN	BASE	VOLT	MODE	KG
21719	3,5	270/1100	250	24°	2700°K	GU10	220-240	DIMM.	0,036
21720	3,5	270/1100	250	24°	3000°K	GU10	220-240	DIMM.	0,036

DISEGNI TECNICI TECHNICAL DRAWING

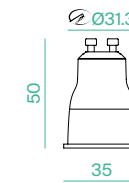

Light_50

Incasso minimale per moduli o diroiche 50mm.
Corpo in pressofusione d'alluminio
Cablato GU10

Minimal recessed downlight for 50mm modules or MR-16 bulbs
Die-cast aluminum body
GU10 base

LIGHT SOURCE



MODULE_PRECISE
50
8.5W



PRO+EVO_REAL
COLOUR
6,5W

FINITURA CORPO BODY FINISHING



Nero/Black



Bianco/White



Oro/Gold

LIGHT_50



CODE	FINISHING	BASE	WATT	VOLT	KG
41283	Bianco/White	GU10	Max 50W	230V 50/60Hz	0,120
41284	Nero/Black	GU10	Max 50W	230V 50/60Hz	0,120
41288	Oro/Gold	GU10	Max 50W	230V 50/60Hz	0,120

INSTALLAZIONE APPLICATION

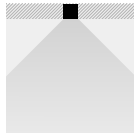

Incasso/Recessed

DISEGNI TECNICI TECHNICAL DRAWING

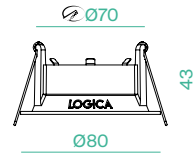

MODULE_PRECISE 50



LED BRIDGELUX
CRI >90
PF >0,8
SDCM 3

Dimmer compatibili pag. 342
Compatible dimmers pag. 342

CODE	WATT	LUMEN 360°/CD	LUMEN 90°	BEAM	KELVIN	VOLT	MODE	KG
21723	8,5W	740 / 4600	710	15°	2700K	220-240V	DIMM.	0,172
21724	8,5W	740 / 3690	710	24°	2700K	220-240V	DIMM.	0,172
21725	8,5W	740 / 1850	710	38°	2700K	220-240V	DIMM.	0,172
21726	8,5W	760 / 4750	730	15°	3000K	220-240V	DIMM.	0,172
21727	8,5W	760 / 3800	730	24°	3000K	220-240V	DIMM.	0,172
21728	8,5W	760 / 1900	730	38°	3000K	220-240V	DIMM.	0,172

DISEGNI TECNICI TECHNICAL DRAWING

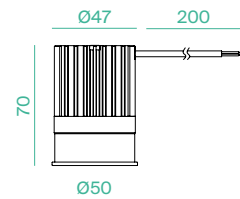

PRO+EVO REAL_COLOUR

LED BRIDGELUX
PF >0,80
SDCM 3

Dimmer compatibili pag. 342
Compatible dimmers pag. 342



PRO+EVO HIGH_OUTPUT



CODE	WATT	LUMEN 360°/CD	LUMEN 90°	BEAM	KELVIN	BASE	VOLT	MODE	CRI	KG
REAL COLOUR										
21756	6,5	500/4900	480	12°	2700°K	GU10	220-240	DIMM.	97	0,060
21758	6,5	530/2120	500	25°	2700°K	GU10	220-240	DIMM.	97	0,060
21760	6,5	530/1100	500	36°	2700°K	GU10	220-240	DIMM.	97	0,060
21762	6,5	530/620	500	60°	2700°K	GU10	220-240	DIMM.	97	0,060
21757	6,5	510/5000	490	12°	3000°K	GU10	220-240	DIMM.	97	0,060
21759	6,5	540/2160	510	25°	3000°K	GU10	220-240	DIMM.	97	0,060
21761	6,5	540/1130	510	36°	3000°K	GU10	220-240	DIMM.	97	0,060
21763	6,5	540/630	510	60°	3000°K	GU10	220-240	DIMM.	97	0,060
HIGH OUTPUT										
21764	6,5	680/4080	630	15°	2700°K	GU10	220-240	DIMM.	90	0,060
21766	6,5	680/2720	630	25°	2700°K	GU10	220-240	DIMM.	90	0,060
21768	6,5	680/1360	630	36°	2700°K	GU10	220-240	DIMM.	90	0,060
21770	6,5	680/780	630	60°	2700°K	GU10	220-240	DIMM.	90	0,060
21765	6,5	700/4260	650	15°	3000°K	GU10	220-240	DIMM.	90	0,060
21767	6,5	700/2840	650	25°	3000°K	GU10	220-240	DIMM.	90	0,060
21769	6,5	700/1420	650	36°	3000°K	GU10	220-240	DIMM.	90	0,060
21771	6,5	700/820	650	60°	3000°K	GU10	220-240	DIMM.	90	0,060

DISEGNI TECNICI TECHNICAL DRAWING



DICRO_50_DTW (DIM TO WARM)

LED BRIDGELUX
CRI 97
PF 0,80
SDCM 3

Dimmer compatibili pag. 342
Compatible dimmers pag. 342

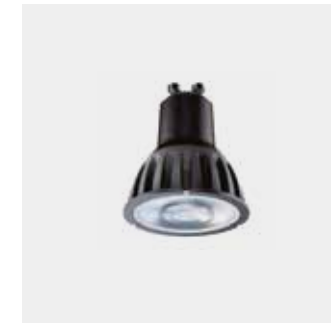

CODE	WATT	LUMEN 360°/CD	LUMEN 90°	BEAM	KELVIN	BASE	VOLT	MODE	KG
21731	6,8	520/1000	480	38°	2200-2700°K	GU10	220-240	DIMM.	0,056

DISEGNI TECNICI TECHNICAL DRAWING



MODULO LED + ADATTATORE FOR LIGHT_50



LED
CRI >90
PF >0,9

CODE	WATT	LUMEN	BEAM	KELVIN	DRIVER	MODE	KG
71606	9W	715	15°	3000K	30-42V 200mA	ON-OFF	0,16
71607	9W	725	24°	3000K	30-42V 200mA	ON-OFF	0,16
71608	9W	710	38°	3000K	30-42V 200mA	ON-OFF	0,16
71609	9W	695	55°	3000K	30-42V 200mA	ON-OFF	0,16
71610	12W	1015	15°	3000K	30-42V 300mA	ON-OFF	0,23
71611	12W	1055	24°	3000K	30-42V 300mA	ON-OFF	0,23
71612	12W	1050	38°	3000K	30-42V 300mA	ON-OFF	0,23
71613	12W	1000	55°	3000K	30-42V 300mA	ON-OFF	0,23
71614	15W	1150	15°	3000K	30-42V 350mA	ON-OFF	0,23
71615	15W	1170	24°	3000K	30-42V 350mA	ON-OFF	0,23
71616	15W	1155	38°	3000K	30-42V 350mA	ON-OFF	0,23
71617	15W	1110	55°	3000K	30-42V 350mA	ON-OFF	0,23
71618	9W	715	15°	3000K	30-42V 200mA	1-10V	0,16
71619	9W	725	24°	3000K	30-42V 200mA	1-10V	0,16
71620	9W	710	38°	3000K	30-42V 200mA	1-10V	0,16
71621	9W	695	55°	3000K	30-42V 200mA	1-10V	0,16
71622	12W	1015	15°	3000K	30-42V 300mA	1-10V	0,23
71623	12W	1055	24°	3000K	30-42V 300mA	1-10V	0,23
71624	12W	1050	38°	3000K	30-42V 300mA	1-10V	0,23
71625	12W	1000	55°	3000K	30-42V 300mA	1-10V	0,23
71626	15W	1150	15°	3000K	30-42V 350mA	1-10V	0,23
71627	15W	1170	24°	3000K	30-42V 350mA	1-10V	0,23
71628	15W	1155	38°	3000K	30-42V 350mA	1-10V	0,23
71629	15W	1110	55°	3000K	30-42V 350mA	1-10V	0,23
71763	9W	715	15°	3000K	30-42V 200mA	DALI/PUSH	0,16
71764	9W	725	24°	3000K	30-42V 200mA	DALI/PUSH	0,16
71765	9W	710	38°	3000K	30-42V 200mA	DALI/PUSH	0,16
71766	9W	695	55°	3000K	30-42V 200mA	DALI/PUSH	0,16
71767	12W	1015	15°	3000K	30-42V 300mA	DALI/PUSH	0,23
71768	12W	1055	24°	3000K	30-42V 300mA	DALI/PUSH	0,23
71769	12W	1050	38°	3000K	30-42V 300mA	DALI/PUSH	0,23
71774	15W	1110	55°	3000K	30-42V 350mA	DALI/PUSH	0,23

CODE	WATT	LUMEN	BEAM	KELVIN	DRIVER	MODE	KG
71770	12W	1000	55°	3000K	30-42V 300mA	DALI/PUSH	0,23
71771	15W	1150	15°	3000K	30-42V 350mA	DALI/PUSH	0,23
71772	15W	1170	24°	3000K	30-42V 350mA	DALI/PUSH	0,23
71773	15W	1155	38°	3000K	30-42V 350mA	DALI/PUSH	0,23



ACCESSORI ACCESSORIES

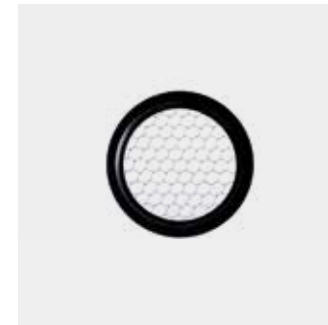

CODE	DESCRIPTION
71575	Filtro honeycomb 9W-12W-15W/ Honeycomb filter 9W-12W-15W

Light_111

Incasso minimale per QR111
Corpo in pressofusione d'alluminio
Cablato GU10

Minimal recessed downlight for QR111 LED bulb
Die-cast aluminum body
GU10 base

LIGHT SOURCE



QR14LED
14W

FINITURA CORPO
BODY FINISHING



Nero/Black



Bianco/White



Oro/Gold

LIGHT_111



CODE	FINISHING	BASE	WATT	VOLT	KG
41285	Bianco/White	GU10	Max 50W	230V 50/60Hz	0,200
41286	Nero/Black	GU10	Max 50W	230V 50/60Hz	0,200
41289	Oro/Gold	GU10	Max 50W	230V 50/60Hz	0,200

INSTALLAZIONE APPLICATION

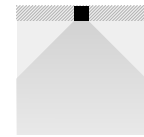

Incasso/Recessed

DISEGNI TECNICI TECHNICAL DRAWING

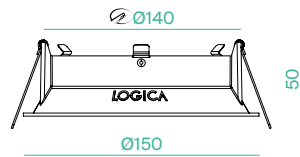

QR14LED REAL_COLOUR HIGH_OUTPUT

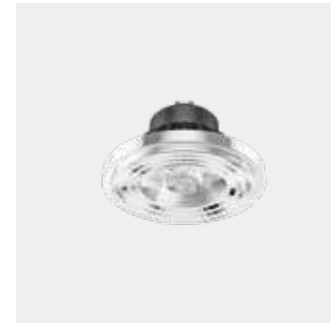

LED BRIDGELUX
PF 0,90
SDCM 3

Dimmer compatibili pag. 342
Compatible dimmers pag. 342

CODE	WATT	LUMEN 360°/CD	LUMEN 90°	BEAM	KELVIN	BASE	VOLT	MODE	CRI	KG
REAL COLOUR										
21773	14	1050/21000	1020	10°	2700°K	GU10	220-240	DIMM.	97	0,244
21774	14	1100/55000	1020	24°	2700°K	GU10	220-240	DIMM.	97	0,244
21775	14	1100/2750	1020	36°	2700°K	GU10	220-240	DIMM.	97	0,244
21776	14	1100/22000	1060	10°	3000°K	GU10	220-240	DIMM.	97	0,244
21777	14	1150/5750	1060	24°	3000°K	GU10	220-240	DIMM.	97	0,244
21778	14	1150/2875	1060	36°	3000°K	GU10	220-240	DIMM.	97	0,244
21779	14	1200/24000	1160	10°	4000°K	GU10	220-240	DIMM.	97	0,244
21780	14	1260/6300	1160	24°	4000°K	GU10	220-240	DIMM.	97	0,244
21781	14	1260/3150	1160	36°	4000°K	GU10	220-240	DIMM.	97	0,244
HIGH OUTPUT										
21782	14	1460/13140	1360	15°	2700°K	GU10	220-240	DIMM.	90	0,244
21783	14	1460/7300	1360	24°	2700°K	GU10	220-240	DIMM.	90	0,244
21784	14	1460/3650	1360	36°	2700°K	GU10	220-240	DIMM.	90	0,244
21785	14	1510/13590	1400	15°	3000°K	GU10	220-240	DIMM.	90	0,244
21786	14	1510/7550	1400	24°	3000°K	GU10	220-240	DIMM.	90	0,244
21787	14	1510/3780	1400	36°	3000°K	GU10	220-240	DIMM.	90	0,244
21788	14	1620/14580	1510	15°	4000°K	GU10	220-240	DIMM.	90	0,244
21789	14	1620/8100	1510	24°	4000°K	GU10	220-240	DIMM.	90	0,244
21790	14	1620/4050	1510	36°	4000°K	GU10	220-240	DIMM.	90	0,244

DISEGNI TECNICI TECHNICAL DRAWING

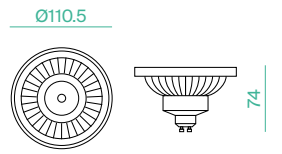

QR18LED

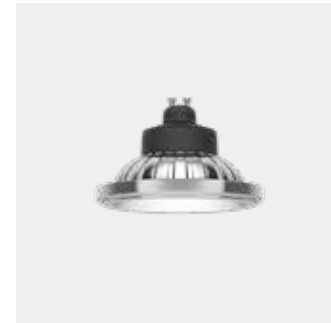

LED EPISTAR
PF 0,90
SDCM 3

Dimmer compatibili pag. 342
Compatible dimmers pag. 342

CODE	WATT	LUMEN 360°/CD	LUMEN 90°	BEAM	KELVIN	BASE	VOLT	MODE	CRI	KG
21698	18	1500/10298	1320	12°	2700°K	GU10	220-240	DIMM.	97	0,170
21700	18	1550/10813	1350	12°	3000°K	GU10	220-240	DIMM.	97	0,170
21702	18	1600/11353	1400	12°	4000°K	GU10	220-240	DIMM.	97	0,170
21699	18	1550/3947	1350	30°	2700°K	GU10	220-240	DIMM.	97	0,170
21701	18	1600/4145	1400	30°	3000°K	GU10	220-240	DIMM.	97	0,170
21703	18	1650/4352	1450	30°	4000°K	GU10	220-240	DIMM.	97	0,170

DISEGNI TECNICI TECHNICAL DRAWING

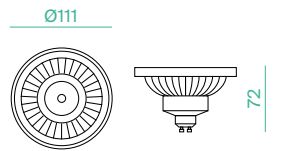

**PD500 DIMMER
COD. 11033**



Rilevazione automatica dei tipi di carico connessi/
Automatic detection of connected load types

Funzione di memoria/
Memory function

Impostazione di luminosità minima/
Minimum brightness setting

Ripristino delle impostazioni di fabbrica/
Restoring factory default settings

INFORMAZIONI GENERALI/GENERAL INFORMATION

Tensione di funzionamento/ <i>Operating Voltage</i>	220-240Vac
Frequenza/ <i>Frequency</i>	50Hz
Temperatura ambientale/ <i>Ambient temperature</i>	-20°C ~ +40°C
Protezione da sovraccarico/ <i>Overload protection</i>	Si/Yes
Protezione contro i cortocircuiti/ <i>Short circuits protection</i>	Si/Yes
Protezione contro il surriscaldamento/ <i>Over temperature protection</i>	Si/Yes
Metodo di connessione/ <i>Connection method</i>	Fili da 0.75 mm ² <i>Wires 0.75mm²</i>
Umidità di funzionamento UR/ <i>Operating humidity RH</i>	0-90% senza condensazione/ 0 to 90% non condensation
Classe di protezione IP/ <i>IP rating</i>	IP20

CARICHI COLLEGABILI/ CONNECTABLE LOADS

Lampade LED dimmerabili/ <i>Dimmable LED Lamps</i>	5-250VA
Trasformatori elettronici/ <i>Electronic Transformers</i>	10-500VA
Lampade a incandescenza, alogene MV/ <i>Incandescent, MV halogen bulbs</i>	500W

**DISEGNI TECNICI
TECHNICAL DRAWING**

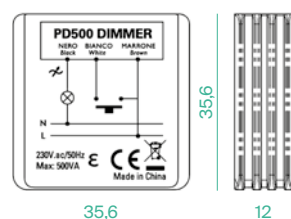

**CARICHI COLLEGABILI /
CONNECTABLE LOADS**



**QR14LED
14 pcs**



**QR18LED
5 pcs**



**PRO+EVO
25 pcs**



**DICRO_PRECISE_35
35 pcs**



**MODULE_PRECISE_50
17 pcs**



**MODULE_PRECISE_35
30 pcs**

Lumis



Incasso basico con corpo in pressofusione
di alluminio di forma tonda e quadrata

*Basic recessed fitting with round or square
die-cast aluminium body*

LUMIS_T



LED BRIDGELUX V8
CRI >90
PF 0,5
SDCM ≥3

CODE	FINISHING	WATT	LUMEN	WATT LIGHT SOURCE	LUMEN LIGHT SOURCE	BEAM	KELVIN	DRIVER	MODE	KG
71948	Bianco/White	12W	1230	10,9W	1460	38°	3000K	30-42V/300mA	ON-OFF	0,19
71949	Nero/Black	12W	1230	10,9W	1460	38°	3000K	30-42V/300mA	ON-OFF	0,19
71950	Bianco/White	12W	1230	10,9W	1460	38°	3000K	30-42V/300mA	1-10V	0,19
71951	Nero/Black	12W	1230	10,9W	1460	38°	3000K	30-42V/300mA	1-10V	0,19
71952	Bianco/White	12W	1230	10,9W	1460	38°	3000K	30-42V/300mA	DALI	0,19
71953	Nero/Black	12W	1230	10,9W	1460	38°	3000K	30-42V/300mA	DALI	0,19

INSTALLAZIONE APPLICATION



Incasso/Recessed

DISEGNI TECNICI TECHNICAL DRAWING

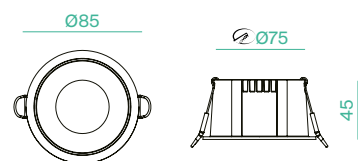

LUMIS_Q



LED BRIDGELUX V8
CRI >90
PF 0,5
SDCM ≥3

CODE	FINISHING	WATT	LUMEN	WATT LIGHT SOURCE	LUMEN LIGHT SOURCE	BEAM	KELVIN	DRIVER	MODE	KG
71956	Bianco/White	12W	1230	10,9W	1460	38°	3000K	30-42V/300mA	ON-OFF	0,22
71957	Nero/Black	12W	1230	10,9W	1460	38°	3000K	30-42V/300mA	ON-OFF	0,22
71958	Bianco/White	12W	1230	10,9W	1460	38°	3000K	30-42V/300mA	1-10V	0,22
71959	Nero/Black	12W	1230	10,9W	1460	38°	3000K	30-42V/300mA	1-10V	0,22
71960	Bianco/White	12W	1230	10,9W	1460	38°	3000K	30-42V/300mA	DALI	0,22
71961	Nero/Black	12W	1230	10,9W	1460	38°	3000K	30-42V/300mA	DALI	0,22

INSTALLAZIONE APPLICATION

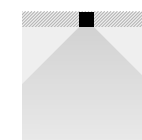

Incasso/Recessed

DISEGNI TECNICI TECHNICAL DRAWING

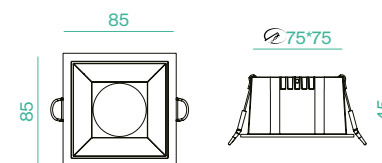

Fulgor_IN



Incasso LED integrato
Corpo estraibile ed orientabile
Corpo in alluminio pressofuso verniciato
Driver incluso

*Integrated LED downlight
Extractable and adjustable body
Painted die-cast aluminium body
Driver included*

FULGOR_IN INCASSO



LED BRIDGELUX
CRI >90
PF >0,95

CODE	FINISHING	WATT	LUMEN	WATT LIGHT SOURCE	LUMEN LIGHT SOURCE	BEAM	KELVIN	DRIVER	KG
41686	Bianco/White	24W	2220	24W	2640	15°	3000K	30-42V 600mA	0,78
41688	Nero/Black	24W	2220	24W	2640	15°	3000K	30-42V 600mA	0,78
41687	Bianco/White	24W	2400	24W	2880	15°	4000K	30-42V 600mA	0,78
41689	Nero/Black	24W	2400	24W	2880	15°	4000K	30-42V 600mA	0,78
41690	Bianco/White	24W	2280	24W	2640	24°	3000K	30-42V 600mA	0,78
41692	Nero/Black	24W	2280	24W	2640	24°	3000K	30-42V 600mA	0,78
41691	Bianco/White	24W	2480	24W	2880	24°	4000K	30-42V 600mA	0,78
41693	Nero/Black	24W	2480	24W	2880	24°	4000K	30-42V 600mA	0,78
41682	Bianco/White	24W	2340	24W	2640	38°	3000K	30-42V 600mA	0,78
41684	Nero/Black	24W	2340	24W	2640	38°	3000K	30-42V 600mA	0,78
41683	Bianco/White	24W	2550	24W	2880	38°	4000K	30-42V 600mA	0,78
41685	Nero/Black	24W	2550	24W	2880	38°	4000K	30-42V 600mA	0,78
41694	Bianco/White	24W	2310	24W	2640	55°	3000K	30-42V 600mA	0,78
41696	Nero/Black	24W	2310	24W	2640	55°	3000K	30-42V 600mA	0,78
41695	Bianco/White	24W	2510	24W	2880	55°	4000K	30-42V 600mA	0,78
41697	Nero/Black	24W	2510	24W	2880	55°	4000K	30-42V 600mA	0,78

INSTALLAZIONE APPLICATION

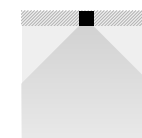

Incasso/Recessed

DISEGNI TECNICI TECHNICAL DRAWINGS

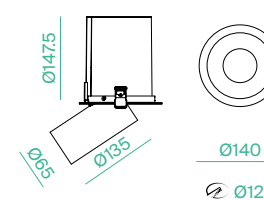

REGOLAZIONI ADJUSTABILITY



ACCESSORI ACCESSORIES

CODE	DESCRIPTION
71663	Filtro Honeycomb 24W Honeycomb Filter 24W

Bellatrix



Incasso led integrato
Corpo in alluminio
CCT selezionabile
Driver non incluso

*Integrated LED recessed fitting
Aluminum body
Selectable CCT
Driver not included*

BELLATRIX



LED OSRAM
CRI >90
PF >0,9
UGR <19

CODE	FINISHING	WATT	LUMEN	BEAM	KELVIN	KG
51011	Bianco/White	10,8W	1234/1278	55°	3000K/4000K	0,15
51012	Bianco/White	16,2W	1712/1779	55°	3000K/4000K	0,19
51013	Bianco/White	21,6W	2430/2500	55°	3000K/4000K	0,26
51014	Bianco/White	27W	2961/3140	55°	3000K/4000K	0,35
51015	Bianco/White	32,4W	3357/3569	55°	3000K/4000K	0,35

INSTALLAZIONE APPLICATION



Incasso/Recessed

DISEGNI TECNICI TECHNICAL DRAWINGS

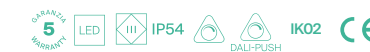
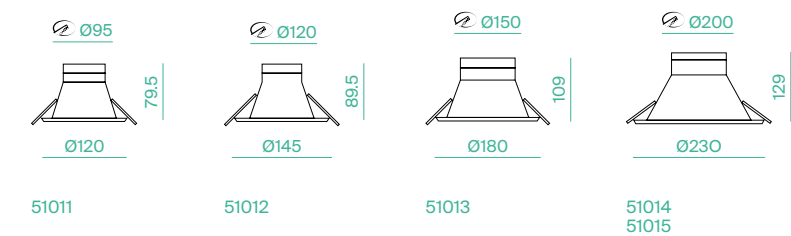

DRIVER

CODE	DESCRIPTION	VOLT	CURRENT	MODE
51016	Driver 12W (10,8W)	36V DC	300mA	ON-OFF
51017	Driver 18W (16,2W)	36V DC	450mA	ON-OFF
51018	Driver 23W (21,6W)	36V DC	600mA	ON-OFF
51019	Driver 28W (27W)	36V DC	750mA	ON-OFF
51020	Driver 35W (32,4W)	36V DC	900mA	ON-OFF
51021	Driver Dimming 12W (10,8W)	36V DC	300mA	TRIAC
51022	Driver Dimming 18W (16,2W)	36V DC	450mA	TRIAC
51023	Driver Dimming 23W (21,6W)	36V DC	600mA	TRIAC
51024	Driver Dimming 28W (27W)	36V DC	750mA	TRIAC
51025	Driver Dimming 35W (32,4W)	36V DC	900mA	TRIAC
51026	Driver 12W (10,8W)	36V DC	300mA	DALI
51027	Driver 18W/23W (16,2W / 21,6W)	36V DC	450-600mA	DALI
51028	Driver 28W/35W (27W / 32,4W)	36V DC	750-900mA	DALI

Efficienza da incasso *Recessed efficiency*

Il riflettore incassato BELLATRIX in polimeri ottici fornisce un'illuminazione omogenea, con un grado di abbagliamento luminoso certificato UGR<19 che assicura la qualità della luce ed il benessere delle persone nel contesto lavorativo.

La resa cromatica CRI>90 garantisce che il tipo di luce emessa rispecchi i colori naturali di ambienti, oggetti o persone.

The deep-set aluminium BELLATRIX reflector made of optical polymer ensures an efficient and homogeneous light with high glare control certified UGR < 19 which provides quality of light and consequently the well-being of people in their working spaces.

The high Colour Rendering Index CRI>90 means that the light emitted guarantees the natural rendering of colours of rooms, objects and people.



L80B20_50000 ore

T° COLORE 3000/4000K
Selezione della temperatura di colore mediante interruttore sul corpo, mantenendo l'efficienza luminosa di ca. 110lm/W.

IP54
L'apparecchio è protetto nella parte frontale contro la polvere e gli spruzzi d'acqua rispettando eventuali normative richieste.

CABLAGGIO SEMPLICE
Le dimensioni dell'apparecchio lo rendono ideale per il relamping e gli spinotti Amp rendono facile e veloce il cablaggio.

DIMMER-ON/OFF/DALI
Possibilità di connessione ad un driver esterno con gestione ON/OFF o TRIAC o DALI.

L80B20_50000 hours

COLOR TEMPERATURE 3000/4000K
Selection of the T° Color Temperature through a switch mounted on the body, maintaining the luminous efficacy at approx 110lm/W unaltered.

IP54
The fitting is protected at the front from dust and water spray complying with eventual IP standards required.

EASY WIRING
The downlight dimensions make it an ideal choice as a retrofit fitting and the Plug-in connection makes wiring easy and fast.

DIMMER-ON/OFF/DALI
Several separate control gears available: ON/OFF or TRIAC or DALI.

Punto

PUNTO è un incasso minimale dedito all'estetica della luce. L'apparecchio è funzionale, senza stilismi decorativi: la sua forma minimale si comporta come una cornice, che avvolge e delimita il fascio di luce emesso. La possibilità di scegliere il riflettore interno, unitamente alle due dimensioni disponibili (PUNTO e PUNTO_L), lo rende adattabile alle diverse esigenze di ciascun ambiente.

PUNTO is a minimal recessed fitting serving the aesthetics of light. The fitting is functional without any particular decorative artifice: its minimal shape works as a frame which surrounds and encircles the light beam emitted. The possibility of choosing the internal reflector, together with the two available sizes (PUNTO and PUNTO_L), makes it adaptable to the different needs of each environment.

L80B20_50000 hrs



CORPO
BODY



1.6W
6W

Nero/Black
Bianco/White

FINITURA RIFLETTORE
REFLECTOR FINISHING

Bianco/White



Nero/Black



Silver



Oro/Gold



PUNTO



LED BRIDGELUX
CRI >90

CODE	BODY FINISHING	FINISHING REFLECTOR	WATT	LUMEN	WATT LIGHT SOURCE	LUMEN LIGHT SOURCE	BEAM	KELVIN	KG
42686	Bianco/White	Bianco/White	1,6W	100	1,6W	130	30°	3000K	0,07
42687	Bianco/White	Argento/Silver	1,6W	100	1,6W	130	30°	3000K	0,07
42688	Bianco/White	Oro/Gold	1,6W	100	1,6W	130	30°	3000K	0,07
42689	Bianco/White	Nero/Black	1,6W	100	1,6W	130	30°	3000K	0,07
42693	Nero/Black	Bianco/White	1,6W	100	1,6W	130	30°	3000K	0,07
42691	Nero/Black	Argento/Silver	1,6W	100	1,6W	130	30°	3000K	0,07
42692	Nero/Black	Oro/Gold	1,6W	100	1,6W	130	30°	3000K	0,07
42690	Nero/Black	Nero/Black	1,6W	100	1,6W	130	30°	3000K	0,07

INSTALLAZIONE APPLICATION

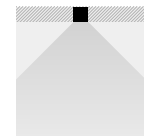

Incasso/Recessed

DISEGNI TECNICI TECHNICAL DRAWINGS

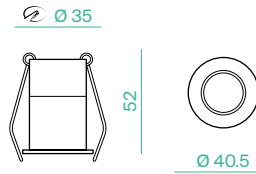

DRIVER

CODE	VOLT	CURRENT	PF	SIZE	MODE
42703	2,52-8V	500mA	>0.5	72x22x22	ON-OFF

PUNTO L



LED CITIZEN
CRI >90

CODE	BODY FINISHING	FINISHING REFLECTOR	WATT	LUMEN	WATT LIGHT SOURCE	LUMEN LIGHT SOURCE	BEAM	KELVIN	KG
42694	Bianco/White	Bianco/White	6W	450	6W	600	25°	3000K	0,12
42695	Bianco/White	Argento/Silver	6W	450	6W	600	25°	3000K	0,12
42696	Bianco/White	Oro/Gold	6W	450	6W	600	25°	3000K	0,12
42697	Bianco/White	Nero/Black	6W	450	6W	600	25°	3000K	0,12
42701	Nero/Black	Bianco/White	6W	450	6W	600	25°	3000K	0,12
42699	Nero/Black	Argento/Silver	6W	450	6W	600	25°	3000K	0,12
42700	Nero/Black	Oro/Gold	6W	450	6W	600	25°	3000K	0,12
42698	Nero/Black	Nero/Black	6W	450	6W	600	25°	3000K	0,12

INSTALLAZIONE APPLICATION

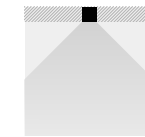

Incasso/Recessed

DISEGNI TECNICI TECHNICAL DRAWINGS

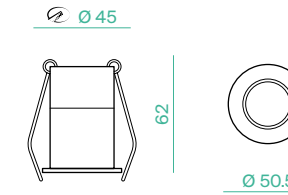

DRIVER

CODE	VOLT	CURRENT	PF	SIZE	MODE
42704	9-20V	500mA	0.5	135x30x20	TRIAC Dimming
42705	12-24V	500mA	0.82	86x32x23	ON-OFF

Occhio

Mini_20 / _105 / _60

Zeus

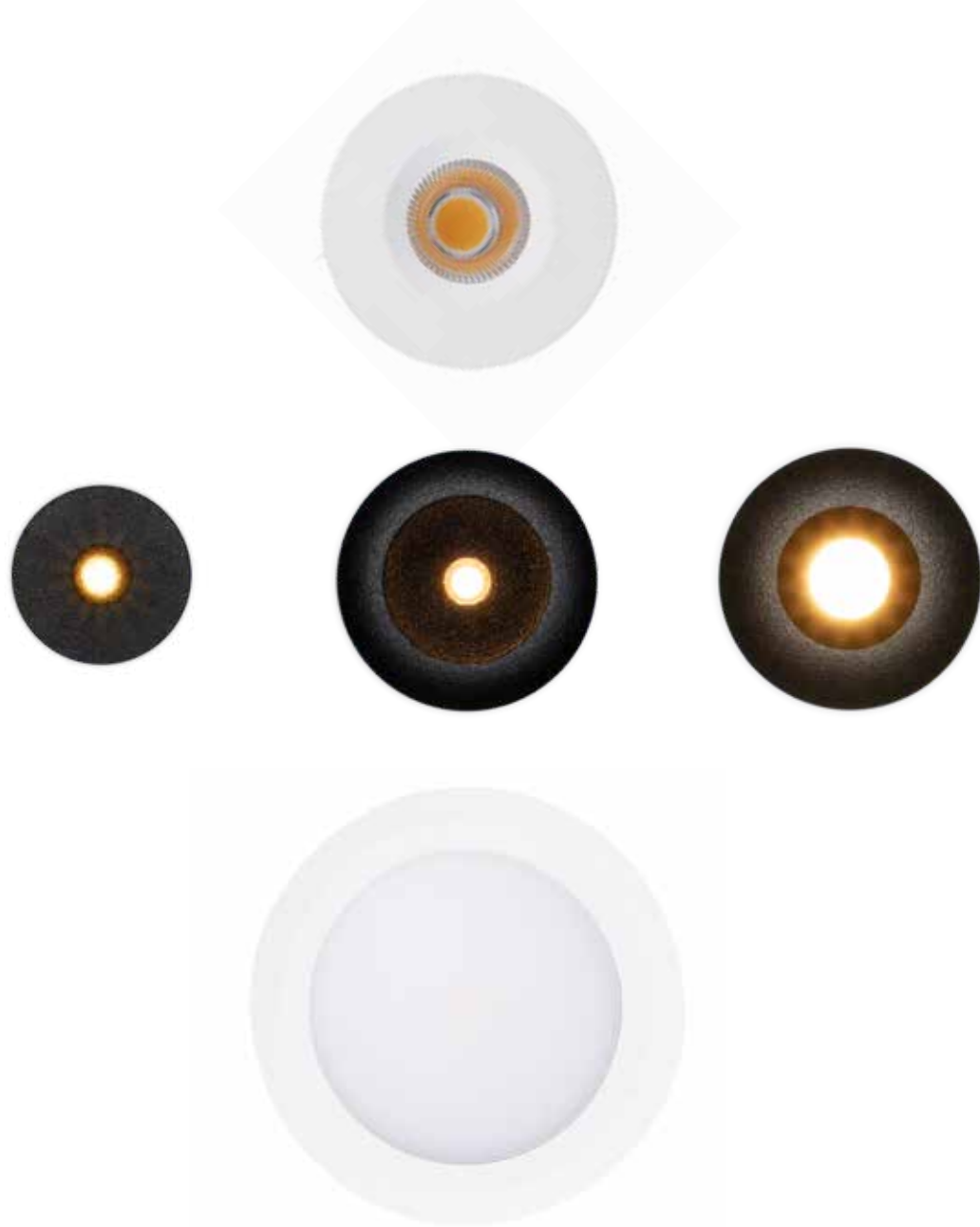

La gamma di punti luce di LOGICA vanta dimensioni ridottissime e diversi angoli di emissione, per una presenza della luce minimale e discreta.

LOGICA's range of light fixtures boasts extremely small dimensions and different beam angles for a minimal and discreet light presence.

OCCHIO



LED EPISTAR
CRI >90

41063 - 41064

41065 - 41066

CODE	FINISHING	WATT	LUMEN	WATT LIGHT SOURCE	LUMEN LIGHT SOURCE	BEAM	KELVIN	KG
41063	Bianco/White	3,5W	250	3,5W	380	60°	3000K	0,06
41064	Nero/Black	3,5W	250	3,5W	380	60°	3000K	0,06
41065	Bianco/White	3,5W	250	3,5W	380	60°	3000K	0,06
41066	Nero/Black	3,5W	250	3,5W	380	60°	3000K	0,06

INSTALLAZIONE
APPLICATION

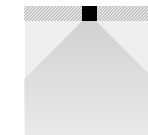

Incasso/Recessed

DISEGNI TECNICI
TECHNICAL DRAWINGS

Ø 36



31,5

Ø 42

41063
41064

Ø 46

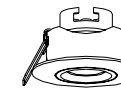

30,5

Ø 52

41065
41066

REGOLAZIONI
ADJUSTABILITY



±15°

3 LED III CE Fix: IP44/20 Adj: IP20

DRIVER

CODE	VOLT	CURRENT	PF	SIZE	MODE
12557	7-14V	300mA	>0.5	53x27x21	ON-OFF
12556	6-12V	300mA	>0.5	40x32x20	PHASE-CUT DIMMING

MINI 20



LED
CRI >80

CODE	FINISHING	WATT	LUMEN	WATT LIGHT SOURCE	LUMEN LIGHT SOURCE	BEAM	KELVIN	KG
42737	Bianco/White	1,2W	92	1,2W	120	20°	3000K	0,04
42738	Nero/Black	1,2W	92	1,2W	120	20°	3000K	0,04

INSTALLAZIONE
APPLICATION

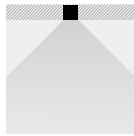

Incasso/Recessed

DISEGNI TECNICI
TECHNICAL DRAWINGS

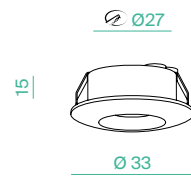

DRIVER

CODE	VOLT	CURRENT	PF	SIZE	MODE
42743	2-5V	350mA	0.5	53x31x21	ON-OFF

MINI 105

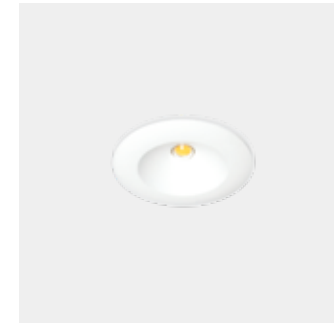

LED
CRI >80

CODE	FINISHING	WATT	LUMEN	WATT LIGHT SOURCE	LUMEN LIGHT SOURCE	BEAM	KELVIN	KG
42739	Bianco/White	1,2W	71	1,2W	120	105°	3000K	0,03
42740	Nero/Black	1,2W	71	1,2W	120	105°	3000K	0,03

INSTALLAZIONE
APPLICATION

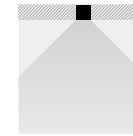

Incasso/Recessed

DISEGNI TECNICI
TECHNICAL DRAWINGS

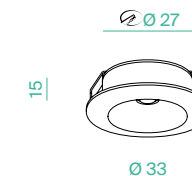

DRIVER

CODE	VOLT	CURRENT	PF	SIZE	MODE
42743	2-5V	350mA	0.5	53x31x21	ON-OFF

MINI 60

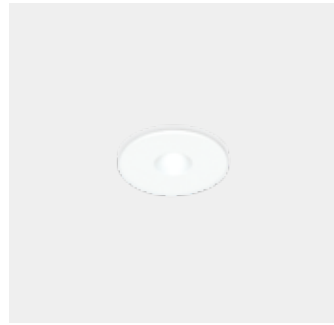

LED
CRI OSRAM
>80

CODE	FINISHING	WATT	LUMEN	WATT LIGHT SOURCE	LUMEN LIGHT SOURCE	BEAM	KELVIN	KG
42741	Bianco/White	1,2W	94	1,2W	120	60°	3000K	0,03
42742	Nero/Black	1,2W	94	1,2W	120	60°	3000K	0,03

INSTALLAZIONE APPLICATION

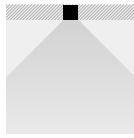

Incasso/Recessed

DISEGNI TECNICI TECHNICAL DRAWINGS

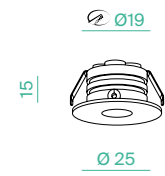

DRIVER

CODE	VOLT	CURRENT	PF	SIZE	MODE
42743	2-5V	350mA	0.5	53x31x21	ON-OFF

ZEUS



LED
CRI EPISTAR
>80

CODE	FINISHING	WATT	LUMEN	WATT LIGHT SOURCE	LUMEN LIGHT SOURCE	BEAM	KELVIN	KG
42745	Bianco/White	3W	285	3W	360	90°	3000K	0,07
42744	Nero/Black	3W	285	3W	360	90°	3000K	0,07

INSTALLAZIONE APPLICATION

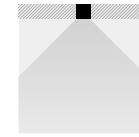

Incasso/Recessed

DISEGNI TECNICI TECHNICAL DRAWINGS



DRIVER

CODE	VOLT	CURRENT	PF	SIZE	MODE
12557	7-14V	300mA	>0.5	53x27x21	ON-OFF
12556	6-12V	300mA	>0.5	40x32x20	PHASE-CUT DIMMING

Aqua_Evo

Incasso LED integrato stagno
Corpo in alluminio pressofuso verniciato
CCT selezionabile
Driver integrato

*Integrated waterproof LED recessed downlight
Die-cast painted aluminum body
Selectable CCT
Integrated driver*



AQUA_EVO COB



LED HONGLI
CRI >80
PF >0,7
SDCM <6

CODE	FINISHING	WATT	LUMEN	LUMEN LIGHT SOURCE	BEAM	KELVIN	KG
40624	Bianco/White	8W	800	750 (90°)	60°	2700/3000/4000K	0,198

INSTALLAZIONE APPLICATION

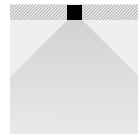

Incasso/Recessed

DISEGNI TECNICI TECHNICAL DRAWINGS

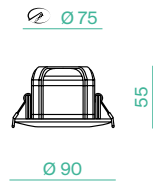

AQUA_EVO SMD

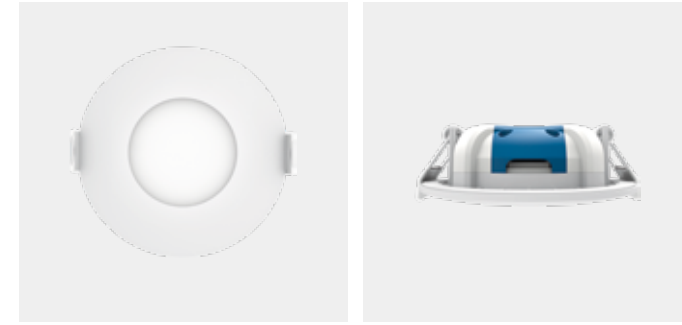

LED HONGLI
CRI >80
PF >0,7
SDCM <6

CODE	FINISHING	WATT	LUMEN	LUMEN LIGHT SOURCE	BEAM	KELVIN	KG
40619	Bianco/White	6W	540	420 (120°)	110°	2700/3000/4000K	0,122

INSTALLAZIONE APPLICATION

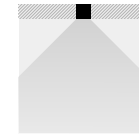

Incasso/Recessed

DISEGNI TECNICI TECHNICAL DRAWINGS

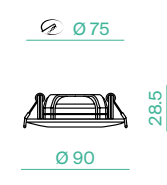

Frame

Frame_111



Incasso regolabile per dicriche e AR111; corpo in acciaio verniciato; cornice in estrusione di alluminio verniciato; lampada non inclusa.

Adjustable downlight for dichroics and AR111; painted steel body; painted aluminum extrusion frame; lamp not included.

Frameless

Frameless_111



FRAME



Lampadina esclusa / Bulb not included

CODE	FINISHING	BASE	WATT	VOLT	SIZE	KG
53421/GU10	Bianco/White	GU10	Max 50W	230V 50/60Hz	118x118x110	0,60
53426/GU10	Nero/Black	GU10	Max 50W	230V 50/60Hz	118x118x110	0,60

INSTALLAZIONE APPLICATION

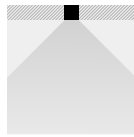

Incasso/Recessed

DISEGNI TECNICI TECHNICAL DRAWINGS

106x106

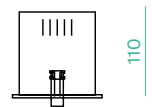

118x118

REGOLAZIONI ADJUSTABILITY



±45°



FRAME



Lampadina esclusa / Bulb not included

CODE	FINISHING	BASE	WATT	VOLT	SIZE	KG
53425/GU10	Bianco/White	GU10	Max 3x50W	230V 50/60Hz	315x118x110	1,00
53428/GU10	Nero/Black	GU10	Max 3x50W	230V 50/60Hz	315x118x110	1,00

INSTALLAZIONE APPLICATION

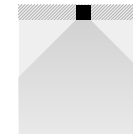

Incasso/Recessed

DISEGNI TECNICI TECHNICAL DRAWINGS

303x106

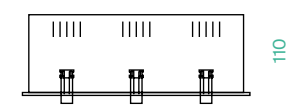

315x118

REGOLAZIONI ADJUSTABILITY



±45°



FRAME



Lampadina esclusa / Bulb not included

CODE	FINISHING	BASE	WATT	VOLT	SIZE	KG
53423/GU10	Bianco/White	GU10	Max 2x50W	230V 50/60Hz	223x118x110	0,80
53427/GU10	Nero/Black	GU10	Max 2x50W	230V 50/60Hz	223x118x110	0,80

INSTALLAZIONE APPLICATION

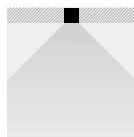

Incasso/Recessed

DISEGNI TECNICI TECHNICAL DRAWINGS

211x106

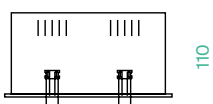

223x118

REGOLAZIONI ADJUSTABILITY



±45°



FRAME 111



Lampadina esclusa / Bulb not included

CODE	FINISHING	BASE	WATT	VOLT	SIZE	KG
53433/GU10	Bianco/White	AR111 GU10	Max 50W	230V 50/60Hz	191x191x150	1,00
53429/GU10	Nero/Black	AR111 GU10	Max 50W	230V 50/60Hz	191x191x150	1,00

INSTALLAZIONE APPLICATION

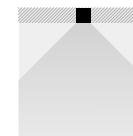

Incasso/Recessed

DISEGNI TECNICI TECHNICAL DRAWINGS

172x172

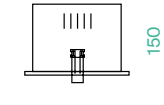

191x191

REGOLAZIONI ADJUSTABILITY



±45°



FRAME 111



Lampadina esclusa / Bulb not included

CODE	FINISHING	BASE	WATT	VOLT	SIZE	KG
53435/GU10	Bianco/White	AR111 GU10	Max 2x50W	230V 50/60Hz	357x191x150	1,80
53430/GU10	Nero/Black	AR111 GU10	Max 2x50W	230V 50/60Hz	357x191x150	1,80

INSTALLAZIONE APPLICATION

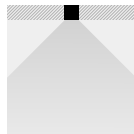

Incasso/Recessed

DISEGNI TECNICI TECHNICAL DRAWINGS

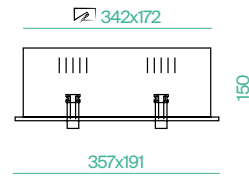

REGOLAZIONI ADJUSTABILITY



FRAMELESS



Lampadina esclusa / Bulb not included

CODE	FINISHING	BASE	WATT	VOLT	SIZE	KG
53448B/GU10	Bianco/White	GU10	Max 50W	230V 50/60Hz	97x97x120	0,80
53448/GU10	Nero/Black	GU10	Max 50W	230V 50/60Hz	97x97x120	0,80

INSTALLAZIONE APPLICATION



Incasso/Recessed

DISEGNI TECNICI TECHNICAL DRAWINGS

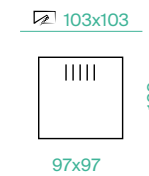

REGOLAZIONI ADJUSTABILITY



FRAME 111



Lampadina esclusa / Bulb not included

CODE	FINISHING	BASE	WATT	VOLT	SIZE	KG
53437/GU10	Bianco/White	AR111 GU10	Max 3x50W	230V 50/60Hz	509x191x150	2,40
53431/GU10	Nero/Black	AR111 GU10	Max 3x50W	230V 50/60Hz	509x191x150	2,40

INSTALLAZIONE APPLICATION

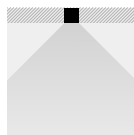

Incasso/Recessed

DISEGNI TECNICI TECHNICAL DRAWINGS

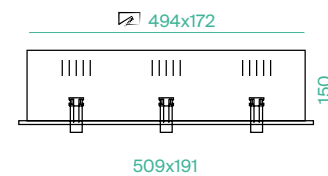

REGOLAZIONI ADJUSTABILITY



FRAMELESS



Lampadina esclusa / Bulb not included

CODE	FINISHING	BASE	WATT	VOLT	SIZE	KG
53449B/GU10	Bianco/White	GU10	Max 2x50W	230V 50/60Hz	202x97x120	1,00
53449/GU10	Nero/Black	GU10	Max 2x50W	230V 50/60Hz	223x118x110	1,00

INSTALLAZIONE APPLICATION

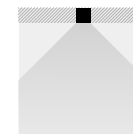

Incasso/Recessed

DISEGNI TECNICI TECHNICAL DRAWINGS

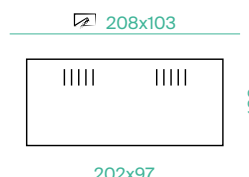

REGOLAZIONI ADJUSTABILITY



FRAMELESS



Lampadina esclusa / Bulb not included

CODE	FINISHING	BASE	WATT	VOLT	SIZE	KG
53450B/GU10	Bianco/White	GU10	Max 3x50W	230V 50/60Hz	294x97x120	1,40
53450/GU10	Nero/Black	GU10	Max 3x50W	230V 50/60Hz	294x97x120	1,40

INSTALLAZIONE APPLICATION

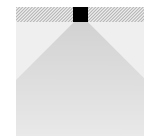

Incasso/Recessed

DISEGNI TECNICI TECHNICAL DRAWINGS



REGOLAZIONI ADJUSTABILITY



FRAMELESS 111



Lampadina esclusa / Bulb not included

CODE	FINISHING	BASE	WATT	VOLT	SIZE	KG
53455B/GU10	Bianco/White	AR111 GU10	Max 2x50W	230V 50/60Hz	325x157x150	1,80
53455/GU10	Nero/Black	AR111 GU10	Max 2x50W	230V 50/60Hz	325x157x150	1,80

INSTALLAZIONE APPLICATION

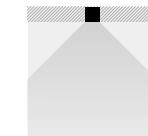

Incasso/Recessed

DISEGNI TECNICI TECHNICAL DRAWINGS



REGOLAZIONI ADJUSTABILITY



FRAMELESS 111



Lampadina esclusa / Bulb not included

CODE	FINISHING	BASE	WATT	VOLT	SIZE	KG
53454B/GU10	Bianco/White	AR111 GU10	Max 50W	230V 50/60Hz	157x157x150	1,00
53454/GU10	Nero/Black	AR111 GU10	Max 50W	230V 50/60Hz	157x157x150	1,00

INSTALLAZIONE APPLICATION

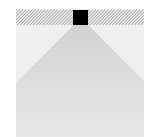

Incasso/Recessed

DISEGNI TECNICI TECHNICAL DRAWINGS

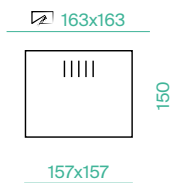

REGOLAZIONI ADJUSTABILITY



FRAMELESS 111



Lampadina esclusa / Bulb not included

CODE	FINISHING	BASE	WATT	VOLT	SIZE	KG
53456B/GU10	Bianco/White	AR111 GU10	Max 3x50W	230V 50/60Hz	477x157x150	2,40
53456/GU10	Nero/Black	AR111 GU10	Max 3x50W	230V 50/60Hz	477x157x150	2,40

INSTALLAZIONE APPLICATION

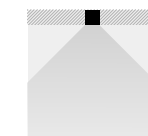

Incasso/Recessed

DISEGNI TECNICI TECHNICAL DRAWINGS

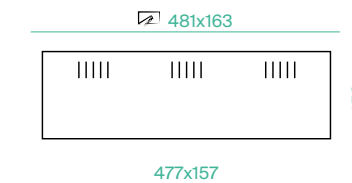

REGOLAZIONI ADJUSTABILITY



Wizard

WIZARD



Lampadina esclusa / Bulb not included

CODE	FINISHING	BASE	WATT	VOLT	KG
42749	Bianco/White	GU10	Max 50W	230V 50/60Hz	0,20
42750	Nero/Black	GU10	Max 50W	230V 50/60Hz	0,20
42747	Bianco/White	AR111 GU10	Max 50W	230V 50/60Hz	0,43
42748	Nero/Black	AR111 GU10	Max 50W	230V 50/60Hz	0,43



INSTALLAZIONE APPLICATION

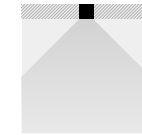

Incasso/Recessed

DISEGNI TECNICI TECHNICAL DRAWINGS

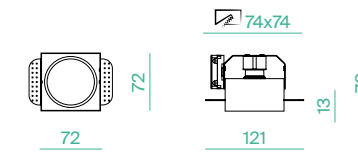

42749
42750

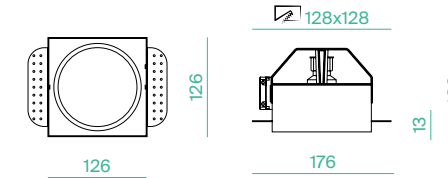

42747
42748

REGOLAZIONI ADJUSTABILITY



Incasso con montaggio a raso per dicroiche e AR111
Corpo in acciaio verniciato
Lampada orientabile
Lampada non inclusa

*Recessed fitting for MR-16 and AR111
Painted steel body
Adjustable lamp
Bulb not included*



Installazione minimale

Minimal fitting

WIZARD si distingue per la sua presenza discreta grazie al montaggio a raso che permette di fondere l'apparecchio con l'architettura della stanza. Può inoltre essere orientato nella versione grande su due assi, rendendolo flessibile per le proprie necessità.

WIZARD distinguishes itself for its discreet presence thanks to its trimless recessed mounting system which softly melts into the architecture of the room. It can also be oriented in the large version on two separate axes, making it flexible for one's needs.

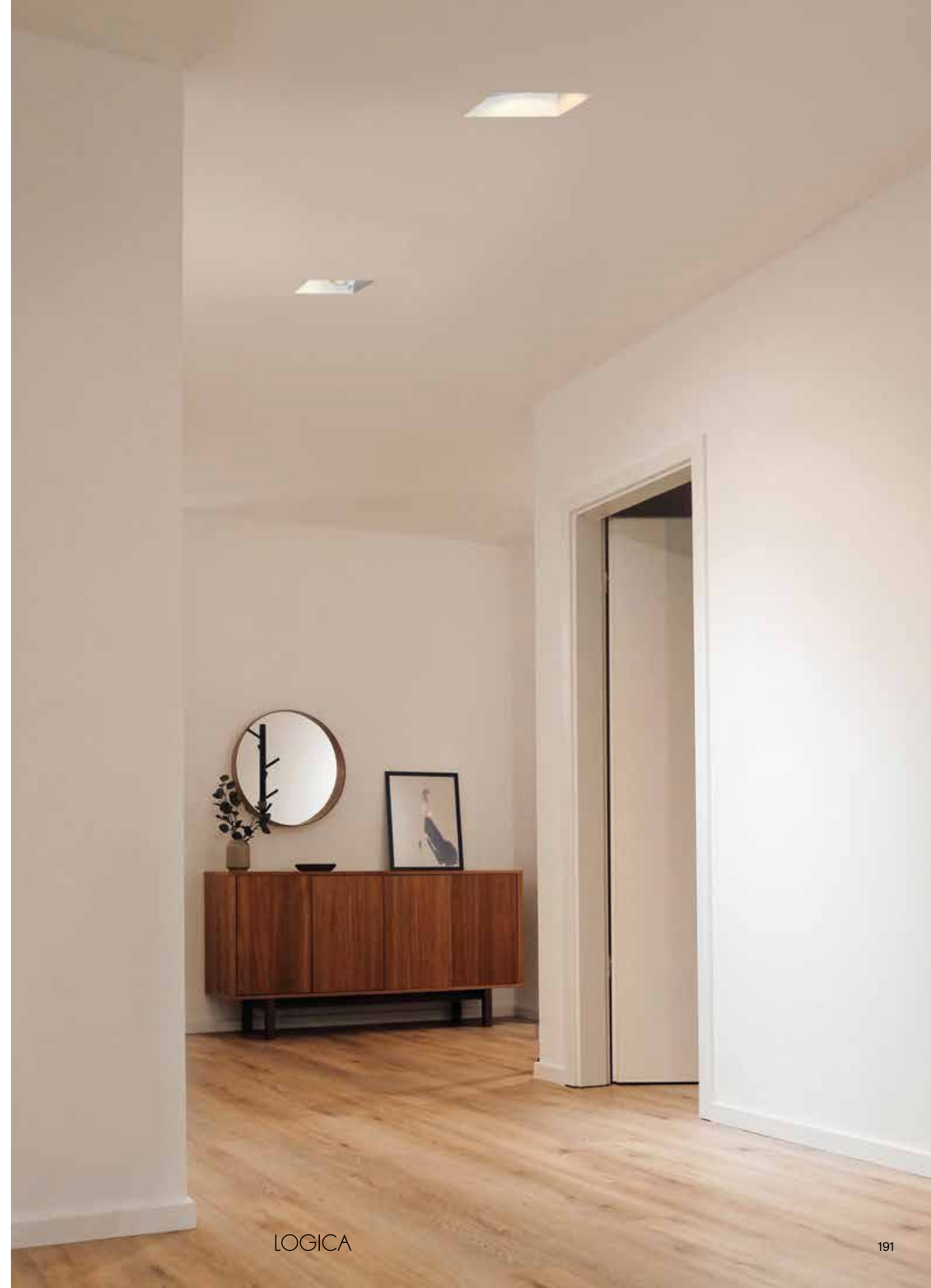
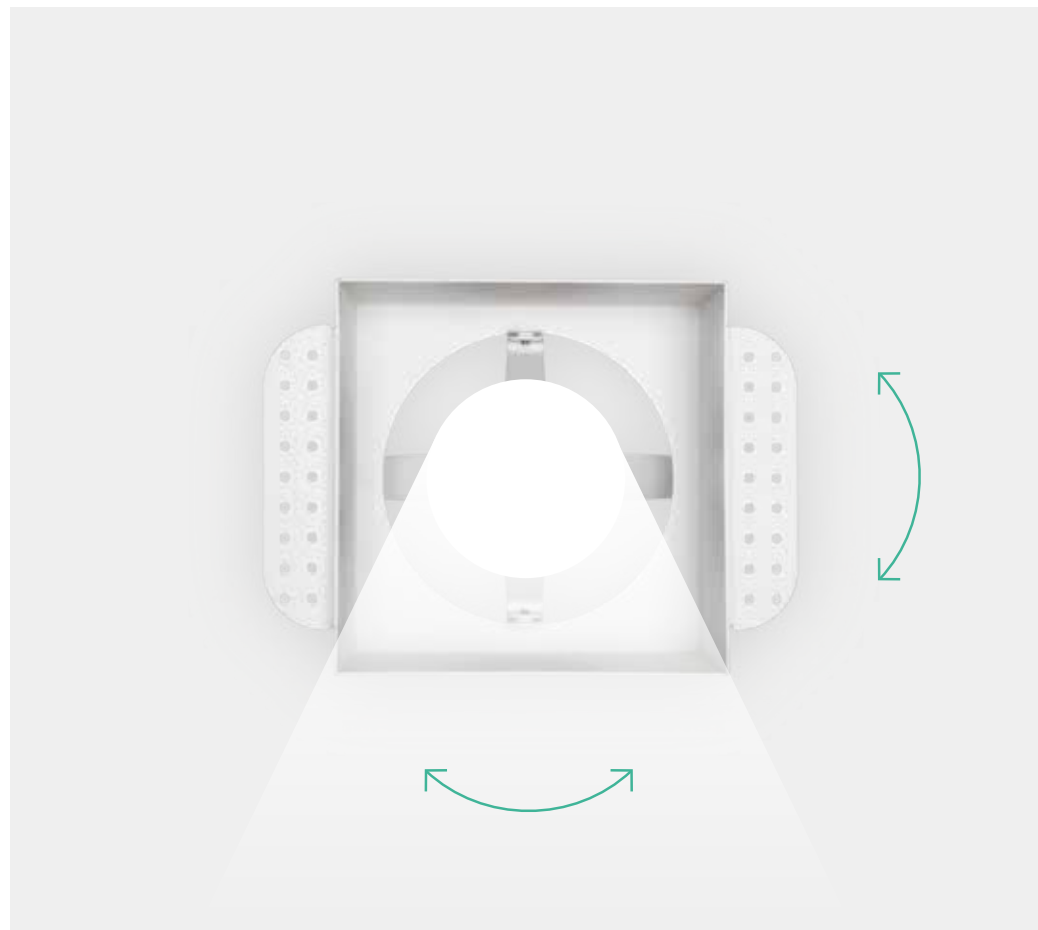

SUSPENSION
LIGHTS

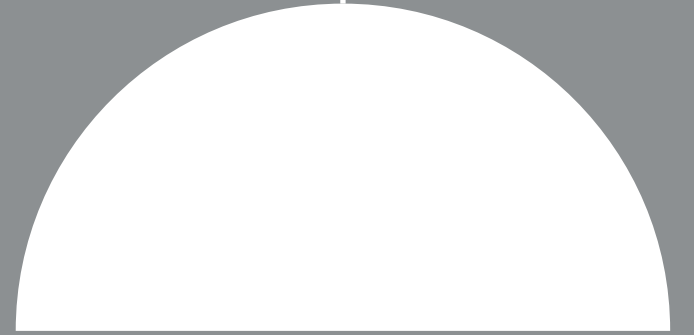
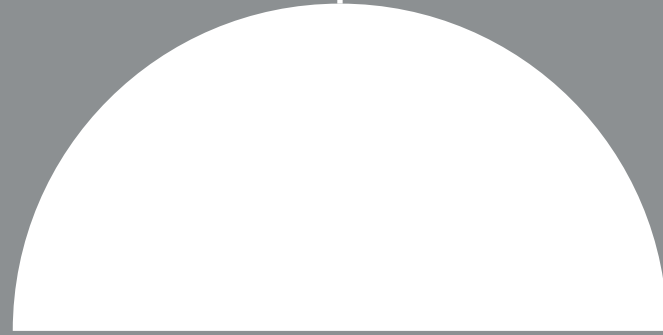
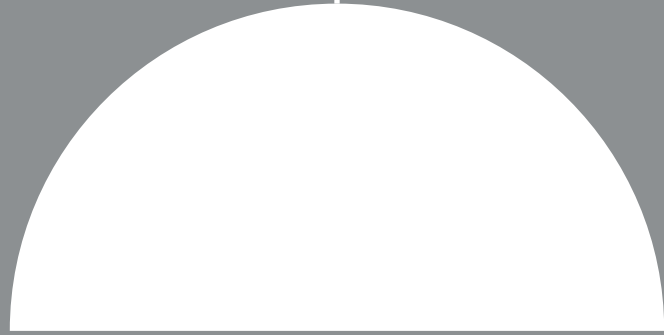
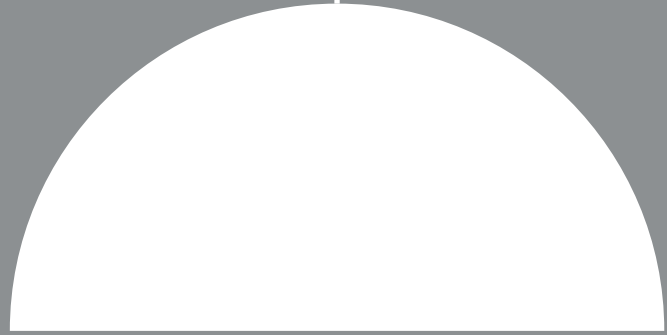



Apparecchio a sospensione LED integrato
Corpo in alluminio estruso verniciato
Driver incluso

*Suspension fitting with built-in LED
Painted extruded aluminium body
Driver included*

A+B SOSPENSIONE DALI-PUSH



LED EPISTAR
CRI >90
PF >0.9
SDCM <6
UGR <16

CODE	FINISHING	WATT	LUMEN	WATT LIGHT SOURCE	LUMEN LIGHT SOURCE	BEAM	KELVIN	DRIVER	MODE	KG
41885	Bianco/White	↓26W+ ↑12W	2412+1471	26W+11,6W	3236+1501	90°+120°	3000K	38W 30-40V 1050mA	ON-OFF, DALI, PUSH	4,00
41887	Bianco/White	↓26W+ ↑12W	2629+1603	26W+11,6W	3603+1636	90°+120°	4000K	38W 30-40V 1050mA	ON-OFF, DALI, PUSH	4,00
41886	Bianco/White	↓38W+ ↑20W	3570+2317	36W+20W	4109+2685	90°+120°	3000K	38W 30-40V 1050mA + 20W 30-40V 500mA	ON-OFF, DALI, PUSH	5,20
41888	Bianco/White	↓38W+ ↑20W	3892+2525	36W+20W	4782+2926	90°+120°	4000K	38W 30-40V 1050mA + 20W 30-40V 500mA	ON-OFF, DALI, PUSH	5,20

INSTALLAZIONE APPLICATION

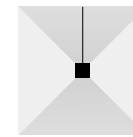

Sospensione/
Suspension

DISEGNI TECNICI TECHNICAL DRAWINGS

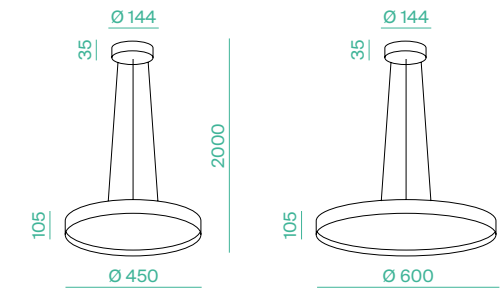

41885
41887

41886
41888

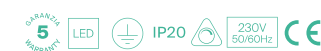

Illuminazione per il benessere visivo

Lighting for sight wellness

L'uso di prodotti illuminotecnici progettati con attenzione al benessere visivo può fare la differenza tra uno spazio confortevole e uno che causa disturbo e affaticamento.

A+B integra uno schermo prismatico il quale, unitamente all'emissione secondaria di luce indiretta, garantisce un'esperienza visiva piacevole e sana, grazie a un grado di UGR<16. Una corretta illuminazione può migliorare la qualità della vita, la produttività e la sicurezza, garantendo un fruizione degli spazi senza disagio o difficoltà, garantendo una esperienza visiva piacevole e sana.

The choice of proper lighting fittings purposely designed to provide visual comfort can make a big difference between a comfortable environment and one which causes eyestrain and tiredness.

A+B combines a direct lighting microprismatic diffuser (UGR<16) with a secondary indirect light source which guarantee a healthy and comfortable visual experience. Proper lighting solutions improve life quality, increase productivity and safety ensuring a pleasant visual experience.

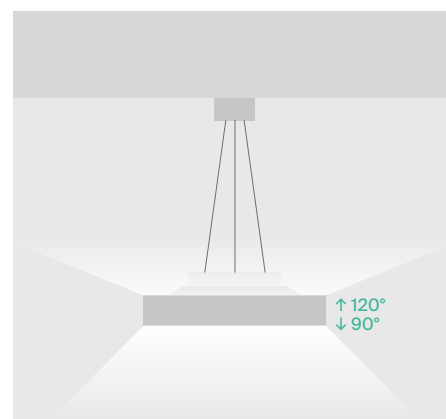

Sospensione
Suspension



Shanghai



Apparecchio a sospensione LED integrato
Corpo in pressofusione di alluminio verniciato
Driver integrato

*Suspension fitting with built-in LED
Painted die-cast aluminium body
Built-in driver*

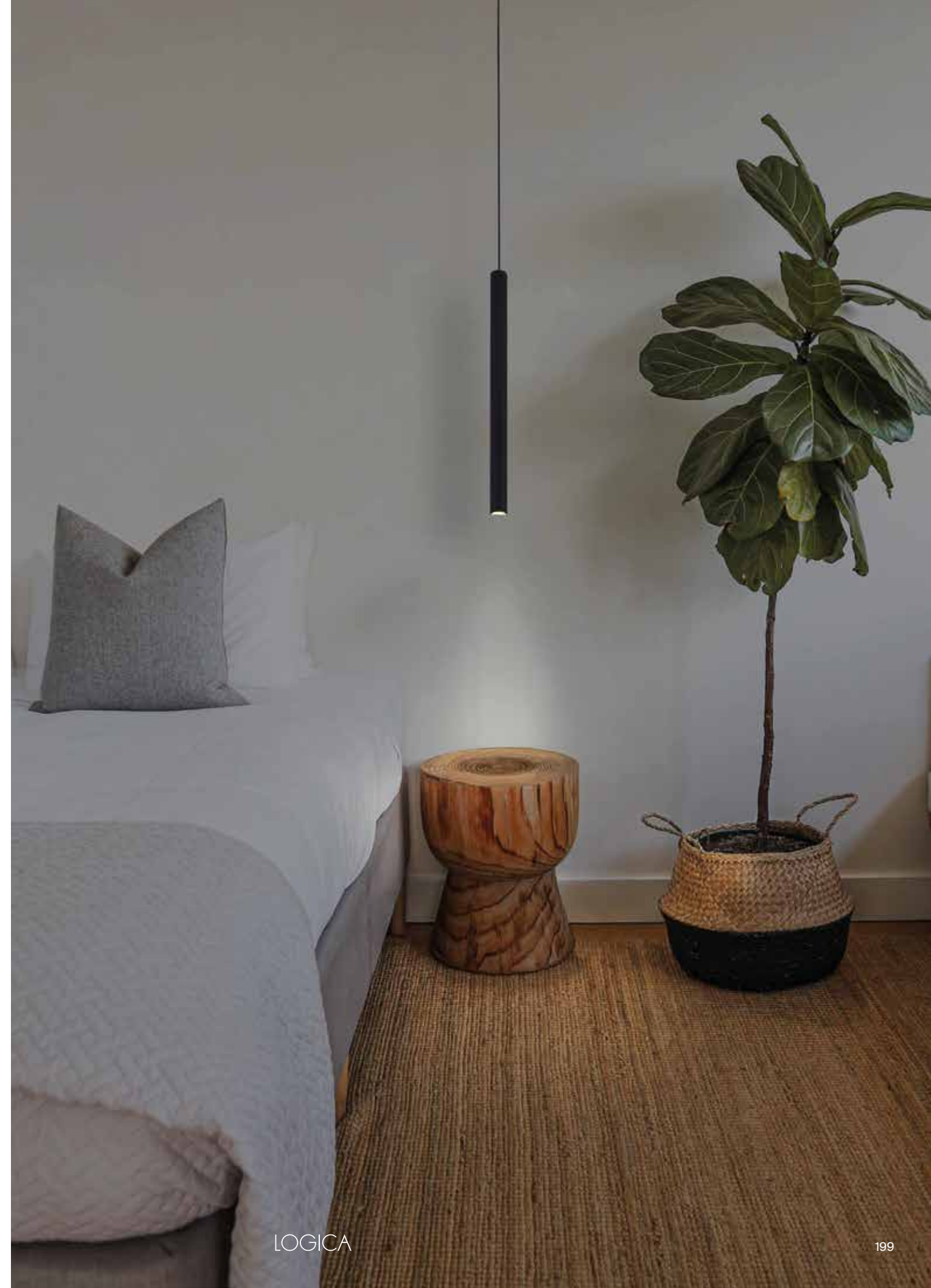

SHANGHAI_30



LED CREE
CRI >90
PF >0.5

CODE	FINISHING	WATT	LUMEN	WATT LIGHT SOURCE	LUMEN LIGHT SOURCE	BEAM	KELVIN	KG
43160	Nero/Black	6W	256	4,8W	450	15°	3000K	0,55
43161	Bianco/White	6W	256	4,8W	450	15°	3000K	0,55

INSTALLAZIONE APPLICATION

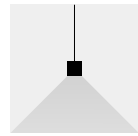

Sospensione/
Suspension

DISEGNI TECNICI TECHNICAL DRAWINGS

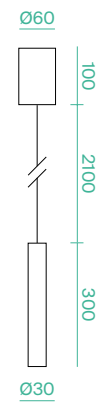

SHANGHAI_50



LED EPISTAR
CRI >90
PF >0.9
SDCM <6
UGR <16

CODE	FINISHING	WATT	LUMEN	WATT LIGHT SOURCE	LUMEN LIGHT SOURCE	BEAM	KELVIN	KG
43162	Nero/Black	6W	256	4,8W	450	15°	3000K	0,55
43163	Bianco/White	6W	256	4,8W	450	15°	3000K	0,55

INSTALLAZIONE APPLICATION

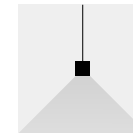

Sospensione/
Suspension

DISEGNI TECNICI TECHNICAL DRAWINGS

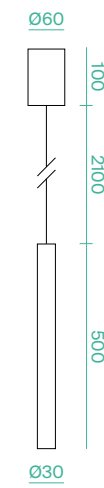

Cyl_Sosp



CYL SOSP



LED BRIDGELUX
CRI >90
PF >0.5

CODE	FINISHING	WATT	LUMEN	WATT LIGHT SOURCE	LUMEN LIGHT SOURCE	BEAM	KELVIN	KG
41707	Nero/Black	12W	890	12W	1680	55°	3000K	0,86
41708	Bianco/White	12W	890	12W	1680	55°	3000K	0,86

INSTALLAZIONE APPLICATION

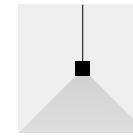

Sospensione/
Suspension

DISEGNI TECNICI TECHNICAL DRAWINGS

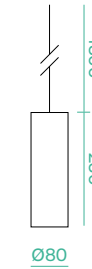

Apparecchio a sospensione LED integrato
Corpo in pressofusione di alluminio verniciato
Driver incluso

*Suspension fitting with built-in LED
Painted die-cast aluminium body
Driver included*



LOGICA

CEILING
LIGHTS



A+B

Apparecchio a soffitto LED integrato
Corpo in alluminio estruso verniciato
Driver incluso

*Ceiling fitting with built-in LED
Painted extruded aluminium body
Driver included*

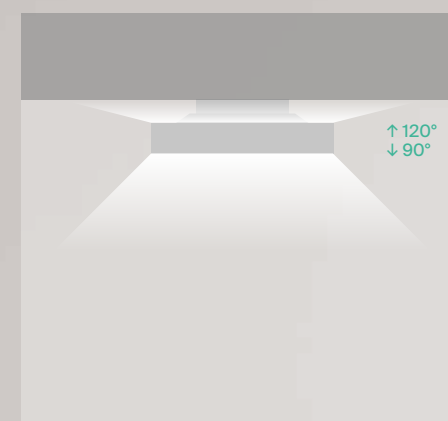

Soffitto
Ceiling

LOGICA



A+B SOFFITTO DALI-PUSH

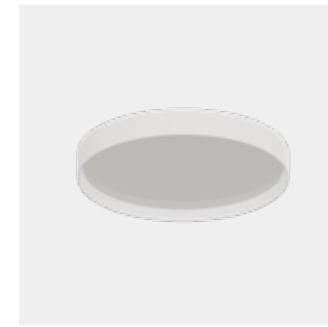

LED EPISTAR
CRI >90
PF >0.9
SDCM <6
UGR <16

CODE	FINISHING	WATT	LUMEN	WATT LIGHT SOURCE	LUMEN LIGHT SOURCE	BEAM	KELVIN	DRIVER	KG
41889	Bianco/White	↓ 26W+ ↑ 12W	2412+1471	26W+11,6W	3236+1501	90°+120°	3000K	38W 30-40V 1050mA	3,60
41891	Bianco/White	↓ 26W+ ↑ 12W	2412+1471	26W+11,6W	3236+1501	90°+120°	4000K	38W 30-40V 1050mA	3,60
41890	Bianco/White	↓ 38W+ ↑ 20W	3570+2317	36W+20W	4109+2685	90°+120°	3000K	38W 30-40V 1050mA + 20W 30-40V 500mA	4,80
41892	Bianco/White	↓ 38W+ ↑ 20W	3570+2317	36W+20W	4109+2685	90°+120°	4000K	38W 30-40V 1050mA + 20W 30-40V 500mA	4,80

INSTALLAZIONE APPLICATION



Soffitto/Ceiling

DISEGNI TECNICI TECHNICAL DRAWINGS



41889
41891

41890
41892

A+B è la soluzione di illuminazione di design perfetta per creare un'atmosfera sofisticata e accogliente nei tuoi ambienti. Con il suo corpo minimale e la sua illuminazione diffusa sia diretta che indiretta, questo prodotto è ideale per arredare con stile ambienti casalinghi e showroom. Disponibile sia in versione a sospensione che a soffitto, A+B si adatta a ogni esigenza di illuminazione e arredamento, creando un'atmosfera unica ed elegante.

A+B is the perfect design lighting solution to create a sophisticated and comfortable atmosphere in your living spaces. Thanks to its minimalistic body in cylindrical shape and its direct and indirect lighting option, this product is an ideal lighting solution both in residential and showroom application. It's available in both suspension and ceiling version and no matter what you choose, it always ensures an elegant and unique atmosphere.



Fulgor



Proiettore LED integrato orientabile
Corpo in alluminio pressofuso verniciato
Driver integrato

*LED adjustable ceiling light
Painted die-cast aluminium body
Driver box on trac*

FULGOR SOFFITTO/ PARETE



LED EPISTAR
CRI >90
PF >0.9

CODE	FINISHING	WATT	LUMEN	WATT LIGHT SOURCE	LUMEN LIGHT SOURCE	BEAM	KELVIN	VOLT	KG
41869	Bianco/ White	15W	1560	14,8W	1710	15°	3000K	36-38V 350mA	0,60
41877	Nero/Black	15W	1560	14,8W	1710	15°	3000K	36-38V 350mA	0,60
41873	Bianco/ White	15W	1557	14,8W	1834	15°	4000K	36-38V 350mA	0,60
41881	Nero/Black	15W	1557	14,8W	1834	15°	4000K	36-38V 350mA	0,60
41870	Bianco/ White	15W	1574	14,8W	1710	24°	3000K	36-38V 350mA	0,60
41878	Nero/Black	15W	1574	14,8W	1710	24°	3000K	36-38V 350mA	0,60
41874	Bianco/ White	15W	1584	14,8W	1834	24°	4000K	36-38V 350mA	0,60
41882	Nero/Black	15W	1584	14,8W	1834	24°	4000K	36-38V 350mA	0,60
41871	Bianco/ White	15W	1591	14,8W	1710	38°	3000K	36-38V 350mA	0,60
41879	Nero/Black	15W	1591	14,8W	1710	38°	3000K	36-38V 350mA	0,60
41875	Bianco/ White	15W	1585	14,8W	1834	38°	4000K	36-38V 350mA	0,60
41883	Nero/Black	15W	1585	14,8W	1834	38°	4000K	36-38V 350mA	0,60
41872	Bianco/ White	15W	1509	14,8W	1710	55°	3000K	36-38V 350mA	0,60
41880	Nero/Black	15W	1509	14,8W	1710	55°	3000K	36-38V 350mA	0,60
41876	Bianco/ White	15W	1531	14,8W	1834	55°	4000K	36-38V 350mA	0,60
41884	Nero/Black	15W	1531	14,8W	1834	55°	4000K	36-38V 350mA	0,60

INSTALLAZIONE APPLICATION



Soffitto/Ceiling



Parete/Wall

DISEGNI TECNICI TECHNICAL DRAWINGS

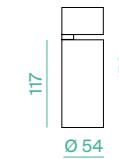

REGOLAZIONI ADJUSTABILITY



ACCESSORI ACCESSORIES

CODE	DESCRIPTION
71575	Filtro Honeycomb 15W Honeycomb Filter 15W

LOGICA

Sun_111



Proiettore GU10 per lampade QR111
Corpo in alluminio pressofuso verniciato

GU10 projector for QR111 lamps
Die-cast painted aluminum body

SUN_111 SOFFITTO/PARETE



Lampadina esclusa / Bulb not included

CODE	FINISHING	BASE	WATT	VOLT	KG
41915	Bianco/White	AR111 GU10	Max 50W	230V 50/60Hz	0,44
41916	Nero/Black	AR111 GU10	Max 50W	230V 50/60Hz	0,44

INSTALLAZIONE APPLICATION

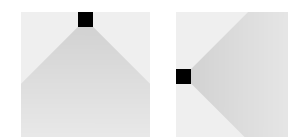

Soffitto/Ceiling

Parete/Wall

DISEGNI TECNICI TECHNICAL DRAWINGS

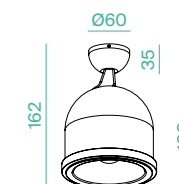

REGOLAZIONI ADJUSTABILITY



35°

90°



QR14LED REAL_COLOUR HIGH_OUTPUT

LED BRIDGELUX
PF 0,90
SDCM 3

Dati tecnici pag. 87
Technical data pag. 87

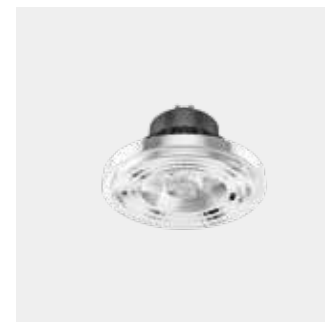

DISEGNI TECNICI TECHNICAL DRAWING

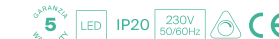
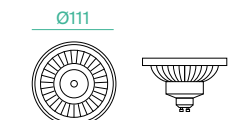

QR18LED

LED BRIDGELUX
PF 0,90
SDCM 3

Dati tecnici pag. 87
Technical data pag. 87

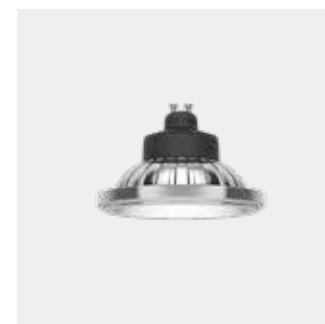

DISEGNI TECNICI TECHNICAL DRAWING

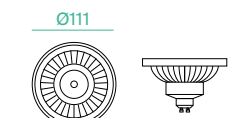

Unico_Dicro



Proiettore orientabile per lampade LED DICRO
Corpo in alluminio verniciato
Montaggio a soffitto
Lampadina non inclusa

*Adjustable tracklight for LED DICRO bulbs
Painted aluminium body
Ceiling mounting
Bulb not included*

UNICO DICRO SOFFITTO/PARETE



Lampadina esclusa /
Bulb not included

CODE	FINISHING	BASE	WATT	VOLT	KG
40760	Bianco/White	GU10	Max 50W	230V 50/60HZ	0,26
40761	Nero/Black	GU10	Max 50W	230V 50/60HZ	0,26

INSTALLAZIONE APPLICATION

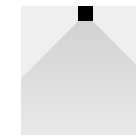

Soffitto/Ceiling



Parete/Wall

DISEGNI TECNICI TECHNICAL DRAWINGS

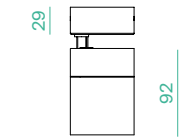

Ø 68

REGOLAZIONI ADJUSTABILITY



355°
90°



LOGICA

Klik_Klak Puntiforme



Apparecchio a soffitto
Corpo in alluminio estruso
Funzionamento a tensione di rete
Driver integrato

*Ceiling fixture
Extruded aluminum body
Mains voltage connection
Built-in driver*

KLICK KLAK PUNTIFORME



LED LIGHTNING
CRI 90
PF 0.6
SDCM 3

CODE	FINISHING	WATT	LUMEN	WATT LIGHT SOURCE	LUMEN LIGHT SOURCE	BEAM	KELVIN	KG
41917	Nero/Black	12W	1000	10W	1298	30°	3000K	0,40
41918	Bianco/White	12W	1000	10W	1298	30°	3000K	0,40
41919	Nero/Black	22W	2065	20W	2622	30°	3000K	0,60
41920	Bianco/White	22W	2065	20W	2622	30°	3000K	0,60
41921	Nero/Black	33W	3170	30W	3911	30°	3000K	0,80
41922	Bianco/White	33W	3170	30W	3911	30°	3000K	0,80

INSTALLAZIONE APPLICATION



Soffitto/Ceiling

DISEGNI TECNICI TECHNICAL DRAWINGS

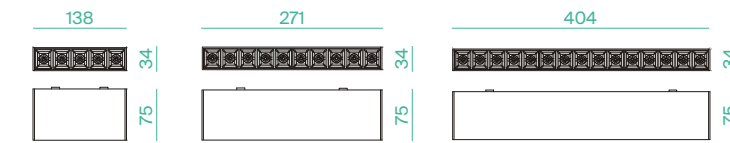

41917
41918

41919
41920

41921
41922





KLIK_KLAK soffitto è l'estensione indipendente del sistema magnetico omonimo, ideato per completare l'illuminazione anche in spazi di passaggio o dove sono richiesti singoli accenti di luce. Realizzato in alluminio estruso, questo prodotto con funzionamento a tensione di rete consente di illuminare con precisione e raffinatezza diversi contesti abitativi o lavorativi.

KLIK_KLAK ceiling is the independent extension of the homonymous magnetic system, designed to complement lighting even in passage areas or where individual light accents are needed. Crafted from extruded aluminum, this product operates on mains voltage, allowing for precise and refined illumination in various residential or work settings.

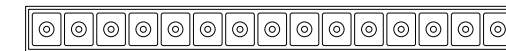

404mm



271mm



138mm

Lumis

Soffitto



Ceiling fitting
Die-cast aluminium body
La sua altezza ridotta permette di inserirlo anche in soffitti bassi

*Apparecchio a soffitto
Corpo in pressofusione di alluminio
Its reduced height allows it to be installed even in low ceilings*

LUMIS_T



LED BRIDGELUX V8
CRI >90
PF 0,5
SDCM ≥3

CODE	FINISHING	WATT	LUMEN	WATT LIGHT SOURCE	LUMEN LIGHT SOURCE	BEAM	KELVIN	DRIVER	KG
71962	Bianco/White	12W	1230	10,9W	1460	38°	3000K	30-42V/300mA	0,19
71963	Nero/Black	12W	1230	10,9W	1460	38°	3000K	30-42V/300mA	0,19

INSTALLAZIONE APPLICATION

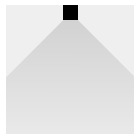

Soffitto/Ceiling

DISEGNI TECNICI TECHNICAL DRAWING

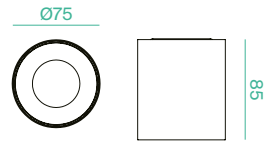

LUMIS_Q



LED BRIDGELUX V8
CRI >90
PF 0,5
SDCM ≥3

CODE	FINISHING	WATT	LUMEN	WATT LIGHT SOURCE	LUMEN LIGHT SOURCE	BEAM	KELVIN	DRIVER	KG
71964	Bianco/White	12W	1230	10,9W	1460	38°	3000K	30-42V/300mA	0,22
71965	Nero/Black	12W	1230	10,9W	1460	38°	3000K	30-42V/300mA	0,22

INSTALLAZIONE APPLICATION



Soffitto/Ceiling

DISEGNI TECNICI TECHNICAL DRAWING

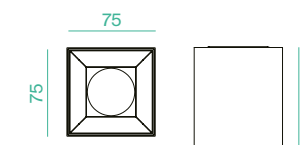

Cyl

Apparecchio a soffitto LED integrato
Corpo in pressofusione di alluminio verniciato
Driver incluso

*Ceiling fitting with built-in LED
Painted die-cast aluminium body
Driver included*

CYL SOFFITTO



LED BRIDGELUX
CRI >90
PF >0.5

CODE	FINISHING	WATT	LUMEN	WATT LIGHT SOURCE	LUMEN LIGHT SOURCE	BEAM	KELVIN	KG
41706	Bianco/White	12W	890	12W	1680	55°	3000K	0,66
41705	Nero/Black	12W	890	12W	1680	55°	3000K	0,66

INSTALLAZIONE APPLICATION



Soffitto/Ceiling

DISEGNI TECNICI TECHNICAL DRAWINGS

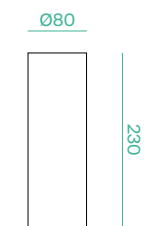

CYL_ DICRO GU10 SOFFITTO



Lampadina esclusa / Bulb not included

CODE	FINISHING	BASE	VOLT	KG
40762	Bianco/White	GU10	230V 50/60HZ	0,25
40763	Nero/Black	GU10	230V 50/60HZ	0,25

INSTALLAZIONE APPLICATION

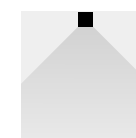

Soffitto/Ceiling

DISEGNI TECNICI TECHNICAL DRAWINGS

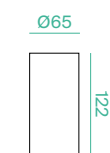

Altair



Proiettore LED orientabile a 360°
Corpo in alluminio pressofuso verniciato
Riflettore brillantato
Driver integrato

*LED adjustable spotlight
Painted die-cast aluminium body
Multi-faceted reflector
Built-in driver*

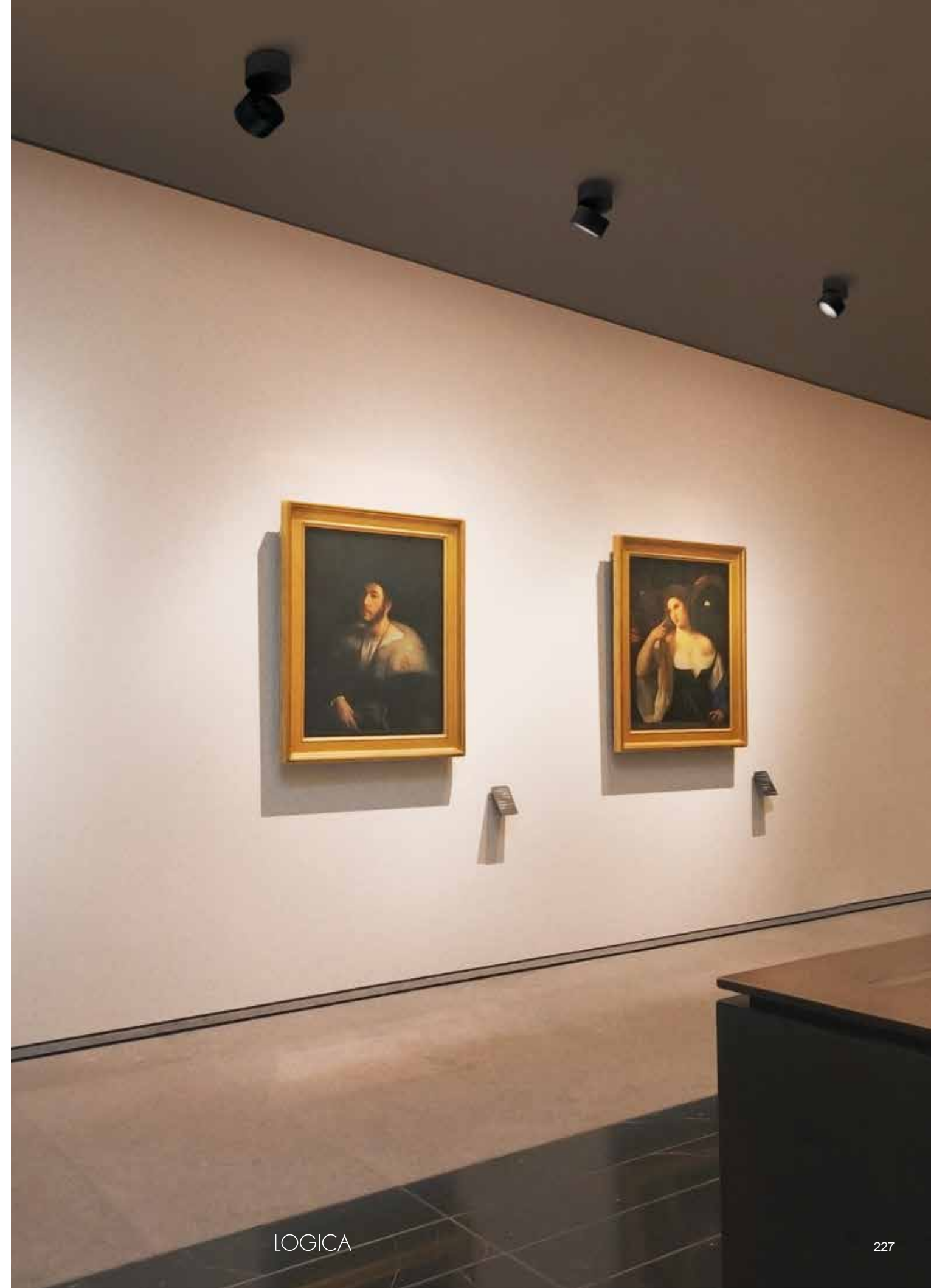

Proiettore minimalista

Minimalist projector

ALTAIR, realizzato in alluminio pressofuso, si caratterizza per un design minimalista che si fonde con qualsiasi ambiente. La sua struttura orientabile offre la possibilità di regolare l'angolo di illuminazione secondo le necessità specifiche. Grazie alla sua versatilità, può essere facilmente installato sia a soffitto che a parete.

ALTAIR, crafted from die-cast aluminum, stands out with its minimalist design that seamlessly integrates into any environment. Its adjustable structure allows for customizing the lighting angle based on specific needs. Thanks to its versatility, it can be effortlessly installed on both ceilings and walls.

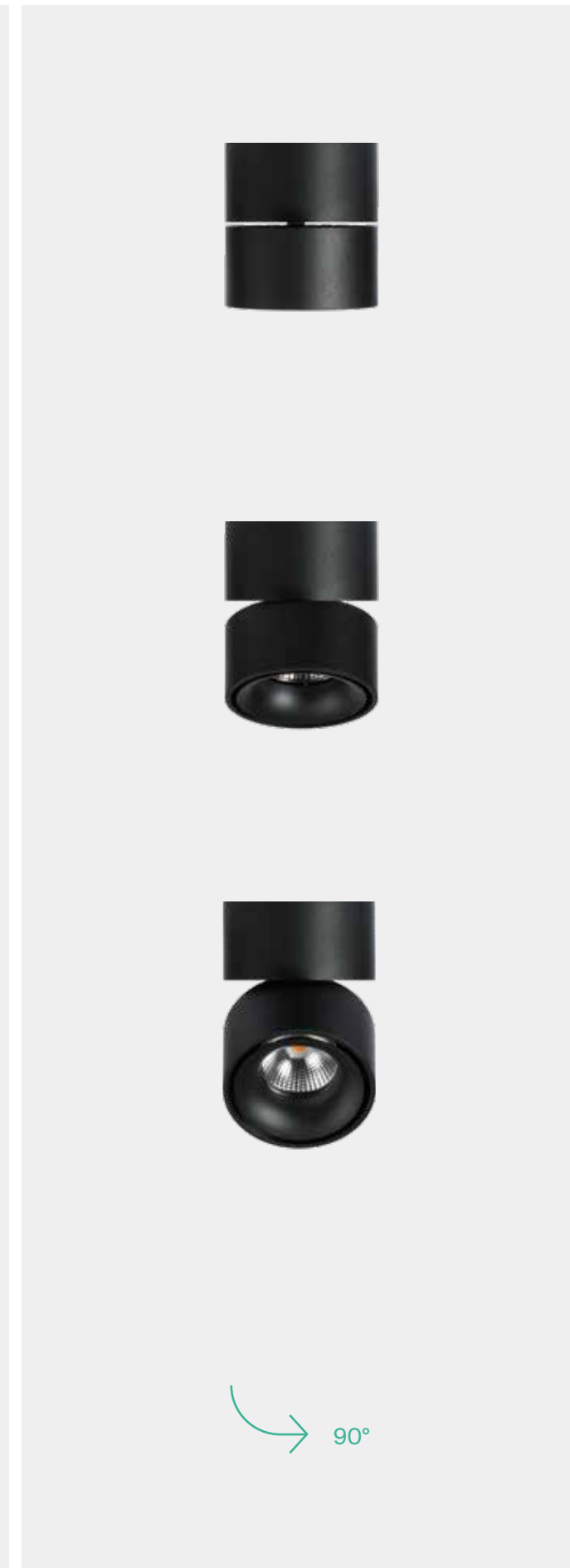
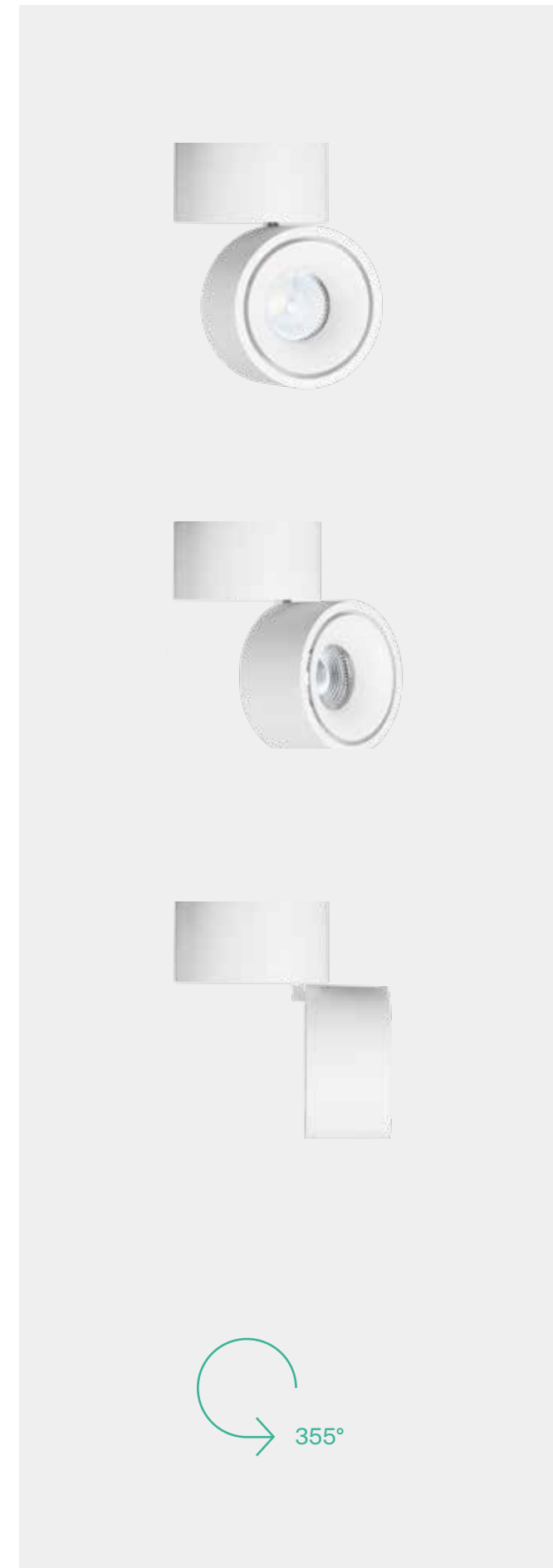
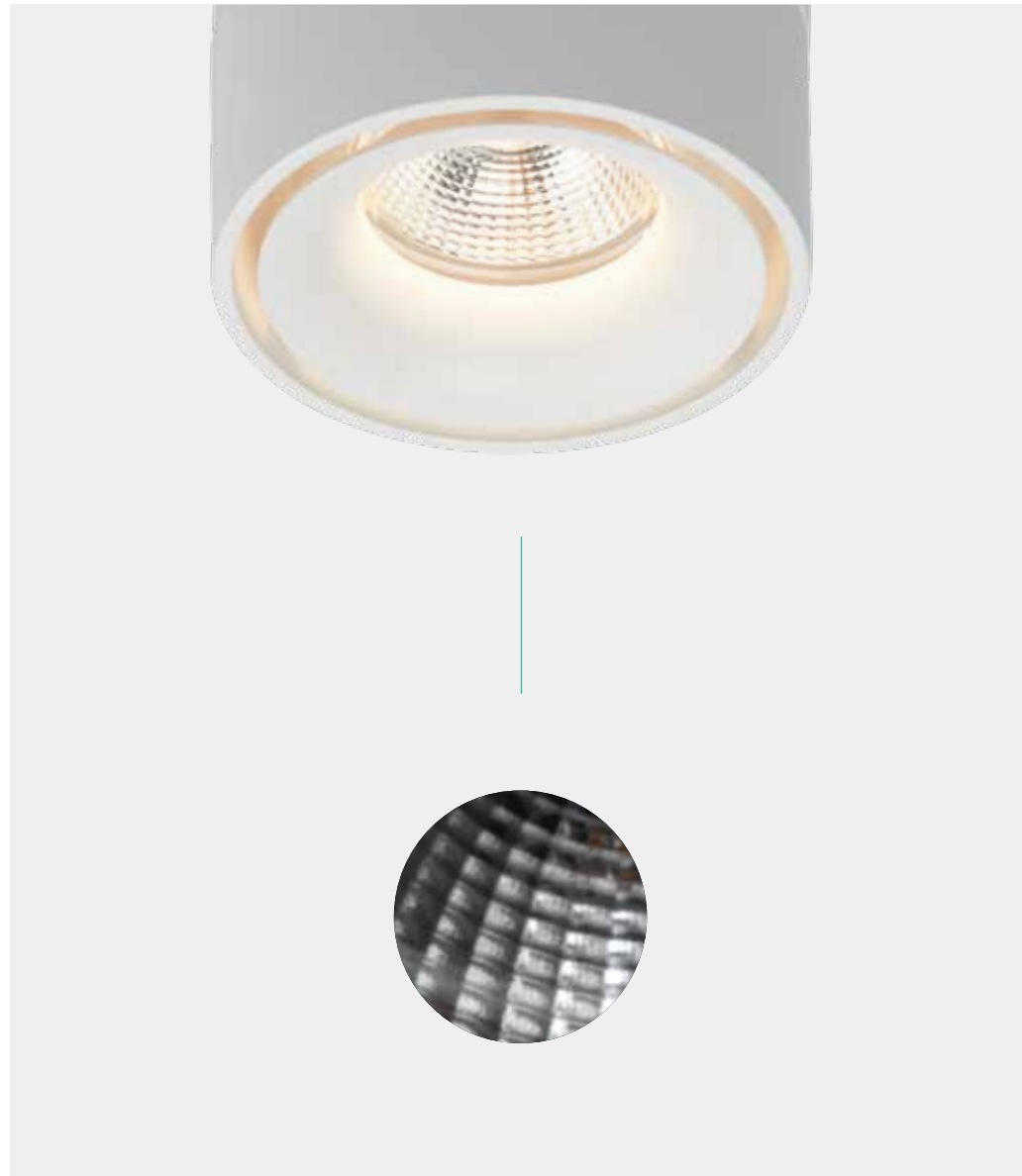

ALTAIR 9.8W SOFFITTO/PARETE



LED EPISTAR
CRI >90
PF >0.9

CODE	FINISHING	WATT	LUMEN	WATT LIGHT SOURCE	LUMEN LIGHT SOURCE	BEAM	KELVIN	MODE	KG
42735	Bianco/White	9,8W	733	9,8W	940	36°	3000K	Dimm. Taglio di fase/ Phase cut dimming	0,36
42736	Nero/Black	9,8W	733	9,8W	940	36°	3000K	Dimm. Taglio di fase/ Phase cut dimming	0,36

INSTALLAZIONE APPLICATION

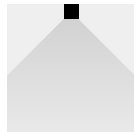

Soffitto/Ceiling

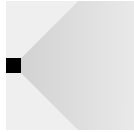

Parete/Wall

DISEGNI TECNICI TECHNICAL DRAWINGS

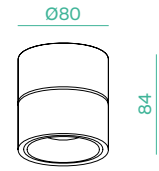

REGOLAZIONI ADJUSTABILITY



ALTAIR 14W SOFFITTO/PARETE

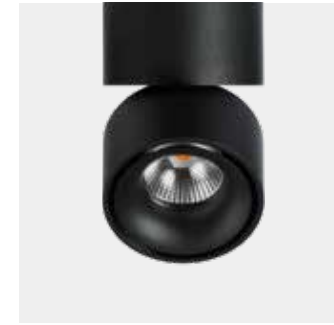

LED EPISTAR
CRI >90
PF >0.9

CODE	FINISHING	WATT	LUMEN	WATT LIGHT SOURCE	LUMEN LIGHT SOURCE	BEAM	KELVIN	MODE	KG
42751	Bianco/White	14W	1050	14W	1400	36°	3000K	Dimm. Taglio di fase/ Phase cut dimming	0,67
42752	Nero/Black	14W	1050	14W	1400	36°	3000K	Dimm. Taglio di fase/ Phase cut dimming	0,67

INSTALLAZIONE APPLICATION



Soffitto/Ceiling



Parete/Wall

DISEGNI TECNICI TECHNICAL DRAWINGS

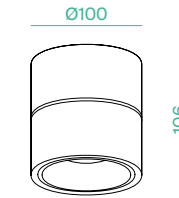

REGOLAZIONI ADJUSTABILITY



Box



Apparecchio a soffitto per dicroiche e AR111
Corpo in alluminio verniciato
Lampadina non inclusa

*Ceiling fitting for MR-16 and AR111
Aluminium steel body
Bulbs not included*



BOX DICRO



Lampadina esclusa / Bulb not included

CODE	FINISHING	BASE	WATT	VOLT	KG
43166	Nero/Black	GU10	MAX 50W	100-240V	0,57
43167	Bianco/White	GU10	MAX 50W	100-240V	0,57

INSTALLAZIONE APPLICATION



Soffitto/Ceiling

DISEGNI TECNICI TECHNICAL DRAWINGS

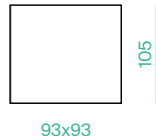

93x93

105

REGOLAZIONI ADJUSTABILITY



±30°

BOX 111



Lampadina esclusa / Bulb not included

CODE	FINISHING	BASE	WATT	VOLT	KG
43164	Nero/Black	AR111 GU10	MAX 20W	100-240V	1,10
43165	Bianco/White	AR111 GU10	MAX 20W	100-240V	1,10

INSTALLAZIONE APPLICATION



Soffitto/Ceiling

DISEGNI TECNICI TECHNICAL DRAWINGS



164x164

124

REGOLAZIONI ADJUSTABILITY



±30°

Container



Apparecchio a soffitto per dicroiche e AR111
Corpo in acciaio verniciato
Lampadina non inclusa

Ceiling fitting for MR-16 and AR111
Painted steel body
Bulbs not included

CONTAINER



Lampadina esclusa / Bulb not included

CODE	FINISHING	BASE	WATT	VOLT	SIZE	KG
56900/230	Interno nero / Inside black	GU10	MAX 50W	100-240V	120x120x120	1,40
57900/230	Interno bianco / Inside white	GU10	MAX 50W	100-240V	120x120x120	1,40

INSTALLAZIONE APPLICATION



Soffitto/Ceiling

DISEGNI TECNICI TECHNICAL DRAWINGS

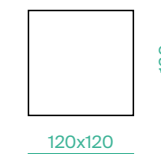

120x120

REGOLAZIONI ADJUSTABILITY



±45°



CONTAINER



Lampadina esclusa / Bulb not included

CODE	FINISHING	BASE	WATT	VOLT	SIZE	KG
56901/230	Interno nero / Inside black	GU10	MAX 2x50W	100-240V	225x120x120	2,20
57901/230	Interno bianco / Inside white	GU10	MAX 2x50W	100-240V	225x120x120	2,20

INSTALLAZIONE APPLICATION



Soffitto/Ceiling

DISEGNI TECNICI TECHNICAL DRAWINGS



225x120

REGOLAZIONI ADJUSTABILITY



±45°



CONTAINER



Lampadina esclusa / Bulb not included

CODE	FINISHING	BASE	WATT	VOLT	SIZE	KG
56902/230	Interno nero / Inside black	GU10	MAX 3x50W	100-240V	317x120x120	3,60
57902/230	Interno bianco / Inside white	GU10	MAX 3x50W	100-240V	317x120x120	3,60

INSTALLAZIONE APPLICATION



Soffitto/Ceiling

DISEGNI TECNICI TECHNICAL DRAWINGS

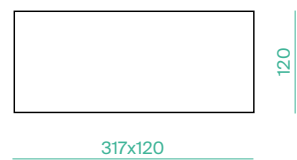

REGOLAZIONI ADJUSTABILITY



CONTAINER 111



Lampadina esclusa / Bulb not included

CODE	FINISHING	BASE	WATT	VOLT	SIZE	KG
56904/230	Interno nero / Inside black	AR111 GU10	MAX 2x50W	100-240V	225x120x120	3,20
57904/230	Interno bianco / Inside white	AR111 GU10	MAX 2x50W	100-240V	225x120x120	3,20

INSTALLAZIONE APPLICATION



Soffitto/Ceiling

DISEGNI TECNICI TECHNICAL DRAWINGS

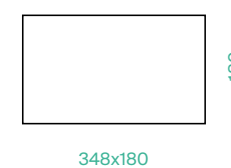

REGOLAZIONI ADJUSTABILITY



CONTAINER 111



Lampadina esclusa / Bulb not included

CODE	FINISHING	BASE	WATT	VOLT	SIZE	KG
53903/230	Interno nero / Inside black	AR111 GU10	MAX 50W	100-240V	120x120x120	2,00
57903/230	Interno bianco / Inside white	AR111 GU10	MAX 50W	100-240V	120x120x120	2,00

INSTALLAZIONE APPLICATION



Soffitto/Ceiling

DISEGNI TECNICI TECHNICAL DRAWINGS

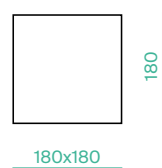

REGOLAZIONI ADJUSTABILITY



CONTAINER 111



Lampadina esclusa / Bulb not included

CODE	FINISHING	BASE	WATT	VOLT	SIZE	KG
56905/230	Interno nero / Inside black	AR111 GU10	MAX 3x50W	100-240V	317x120x120	5,20
57905/230	Interno bianco / Inside white	AR111 GU10	MAX 3x50W	100-240V	317x120x120	5,20

INSTALLAZIONE APPLICATION



Soffitto/Ceiling

DISEGNI TECNICI TECHNICAL DRAWINGS



REGOLAZIONI ADJUSTABILITY



WALL
LIGHTS



Torcia_V



Elegante apparecchio a parete.
In versione verticale ed orizzontale.
L'ampia gamma di finiture lo rende adatto a tutti gli ambienti arredati.
La possibilità di cambiare il CCT (2700K o 3000K) permette di
ottenere la luce preferita per il miglior comfort.



*Elegant wall-mounted fitting.
Available in vertical and horizontal versions
The wide range of finish sings makes it suitable for all furnished environments.
The possibility to change the CCT (2700K or 3000K) allows you
to achieve the best light for optimal comfort.*

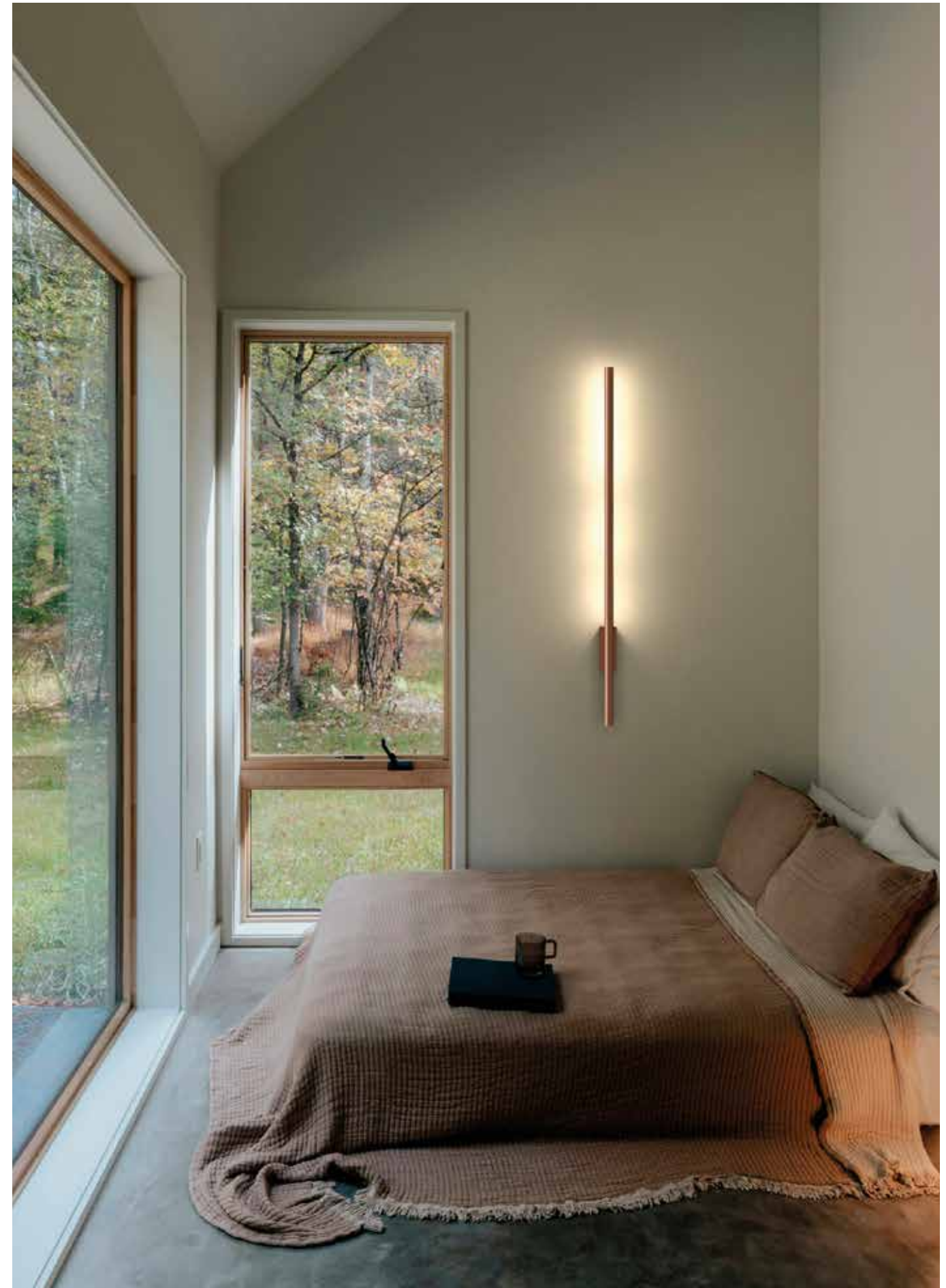

TORCIA_V



LED OSRAM
CRI >90
PF 0.95
SDCM 3

CODE	FINISHING	WATT	LUMEN 2700K	LUMEN 3000K	WATT LIGHT SOURCE	LUMEN LIGHT SOURCE 2700K	LUMEN LIGHT SOURCE 3000K	KELVIN	MODE	IP	KG
41444	White Snow	6,6W	377	397	4,83	657	694	2700 /3000K	TRIAC	IP65	0,65
41445	Black Velvet	6,6W	377	397	4,83	657	694	2700 /3000K	TRIAC	IP65	0,65
41446	Royal Gold	6,6W	377	397	4,83	657	694	2700 /3000K	TRIAC	IP20	0,65
41447	Vintage Brass	6,6W	377	397	4,83	657	694	2700 /3000K	TRIAC	IP20	0,65
41448	White Snow	8,5W	529	546	6,43	966	995	2700 /3000K	TRIAC	IP65	0,70
41449	Black Velvet	8,5W	529	546	6,43	966	995	2700 /3000K	TRIAC	IP65	0,70
41450	Royal Gold	8,5W	529	546	6,43	966	995	2700 /3000K	TRIAC	IP20	0,70
41451	Vintage Brass	8,5W	529	546	6,43	966	995	2700 /3000K	TRIAC	IP20	0,70

INSTALLAZIONE APPLICATION



Parete/Wall

DISEGNI TECNICI TECHNICAL DRAWINGS

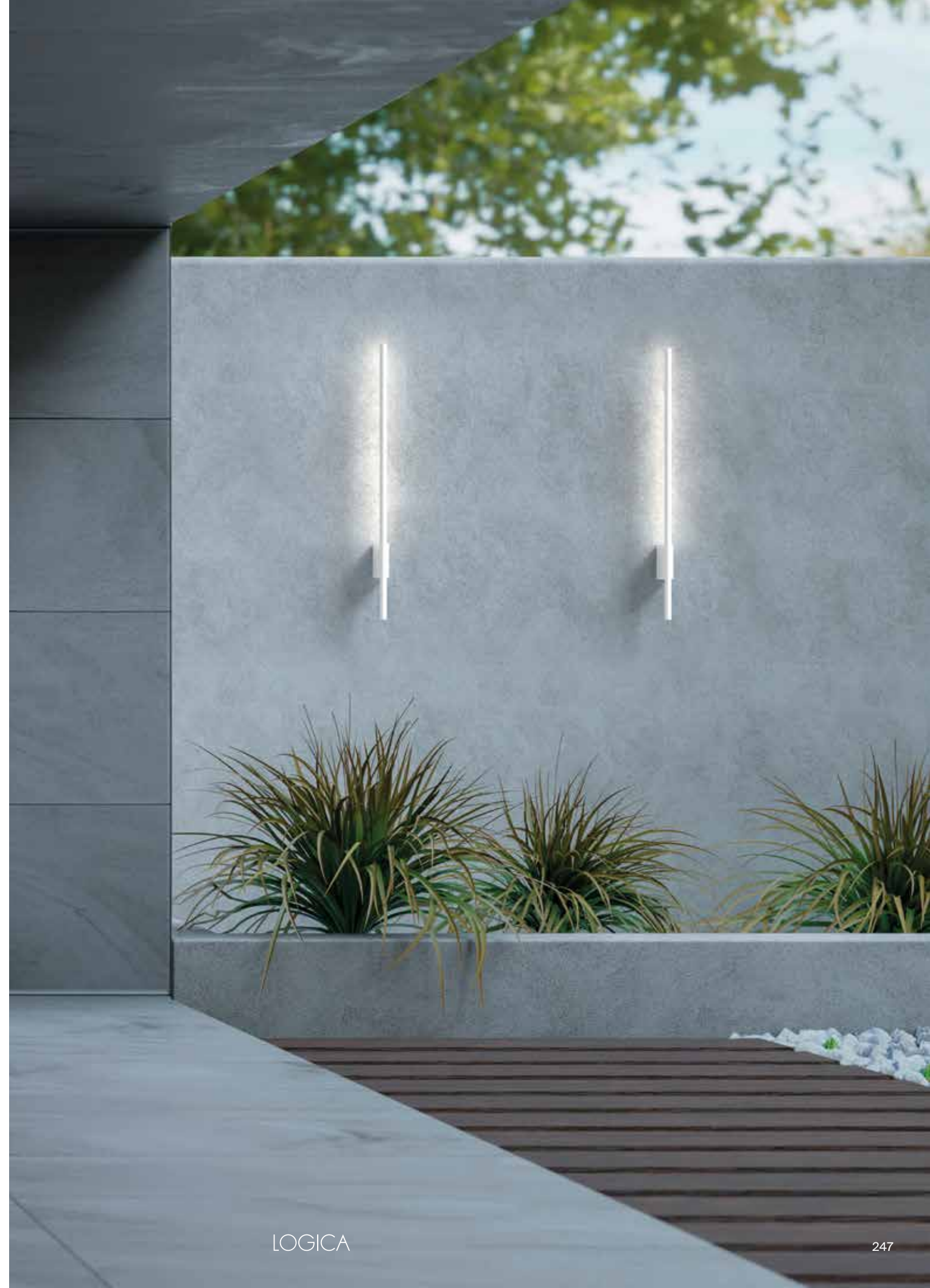
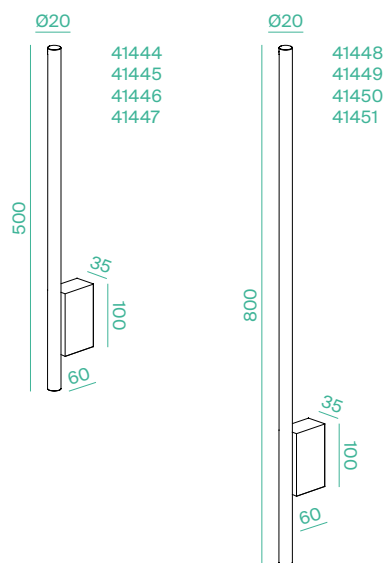

Torcia_O



Elegante apparecchio a parete.
In versione verticale ed orizzontale.
L'ampia gamma di finiture lo rende adatto a tutti gli ambienti arredati.
La possibilità di cambiare il CCT (2700K o 3000K) permette di
ottenere la luce preferita per il miglior comfort.



*Elegant wall-mounted fitting.
Available in vertical and horizontal versions
The wide range of finish sings makes it suitable for all furnished environments.
The possibility to change the CCT (2700K or 3000K) allows you
to achieve the best light for optimal comfort.*



TORCIA_O



LED OSRAM
 CRI >90
 PF 0.96 15W / 0.97 21W
 SDCM 3

CODE	FINISHING	WATT	LUMEN 2700K	LUMEN 3000K	WATT LIGHT SOURCE	LUMEN LIGHT SOURCE 2700K	LUMEN LIGHT SOURCE 3000K	KELVIN	MODE	IP	KG
41452	White Snow	15W	1018	1040	11,85	1496	1576	2700 /3000K	TRIAC	IP65	0,90
41453	Black Velvet	15W	1018	1040	11,85	1496	1576	2700 /3000K	TRIAC	IP65	0,90
41454	Royal Gold	15W	1018	1040	11,85	1496	1576	2700 /3000K	TRIAC	IP20	0,90
41455	Vintage Brass	15W	1018	1040	11,85	1496	1576	2700 /3000K	TRIAC	IP20	0,90
41456	White Snow	21W	1430	1458	17,07	1923	2249	2700 /3000K	TRIAC	IP65	1,15
41457	Black Velvet	21W	1430	1458	17,07	1923	2249	2700 /3000K	TRIAC	IP65	1,15
41458	Royal Gold	21W	1430	1458	17,07	1923	2249	2700 /3000K	TRIAC	IP20	1,15
41459	Vintage Brass	21W	1430	1458	17,07	1923	2249	2700 /3000K	TRIAC	IP20	1,15

INSTALLAZIONE APPLICATION



Parete/Wall

DISEGNI TECNICI TECHNICAL DRAWINGS

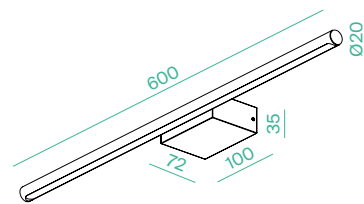

41452
 41453
 41454
 41455

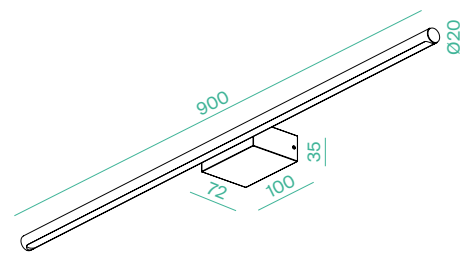

41456
 41457
 41458
 41459

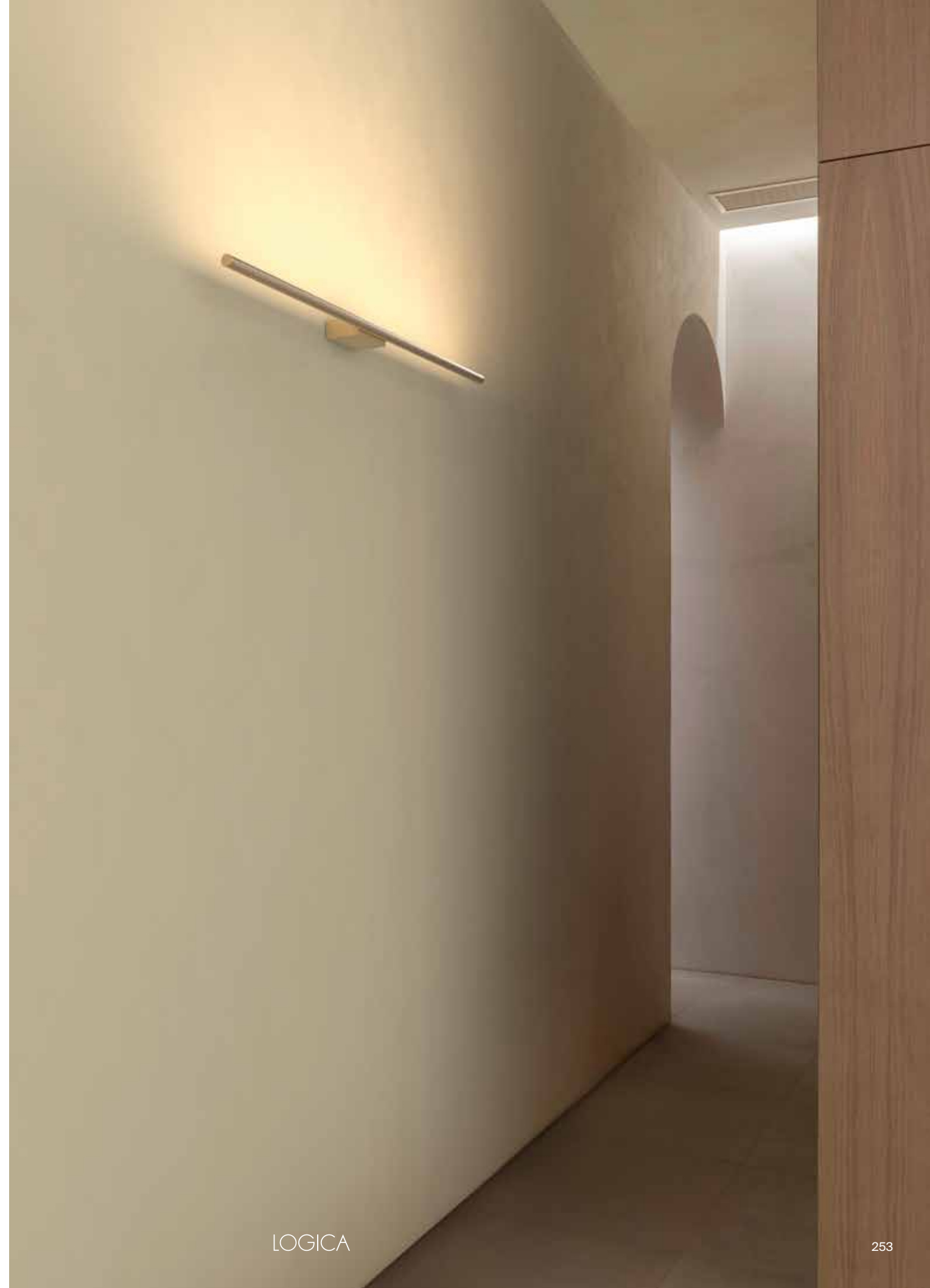

Minima



Apparecchio con montaggio a parete
Corpo in alluminio lavorato dal pieno
Led integrato con dimmerazione a taglio di fase
Driver integrato

Wall fitting
Aluminium body obtained from an aluminium block
Phase-cut dimming integrated LED
Built-in driver

MINIMA



LED SMD-RUNLITE
CRI >90
PF >0.9
SDCM 5

CODE	FINISHING	WATT	LUMEN	WATT LIGHT SOURCE	LUMEN LIGHT SOURCE	BEAM	KELVIN	MODE	KG
42531	Bianco/White	14W	1190	9,94W	2583	107°	3000K	Dimm. Taglio di fase/Phase cut dimming	0,70
42532	Nero/Black	14W	1190	9,94W	2583	107°	3000K	Dimm. Taglio di fase/Phase cut dimming	0,70
42706	Bianco/White	18W	1570	12,96W	3240	107°	3000K	Dimm. Taglio di fase/Phase cut dimming	0,91
42707	Nero/Black	18W	1570	12,96W	3240	107°	3000K	Dimm. Taglio di fase/Phase cut dimming	0,91
42708	Bianco/White	24W	1920	17,71W	4428	107°	3000K	Dimm. Taglio di fase/Phase cut dimming	1,13
42709	Nero/Black	24W	1920	17,71W	4428	107°	3000K	Dimm. Taglio di fase/Phase cut dimming	1,13

INSTALLAZIONE APPLICATION



Parete/Wall

DISEGNI TECNICI TECHNICAL DRAWINGS

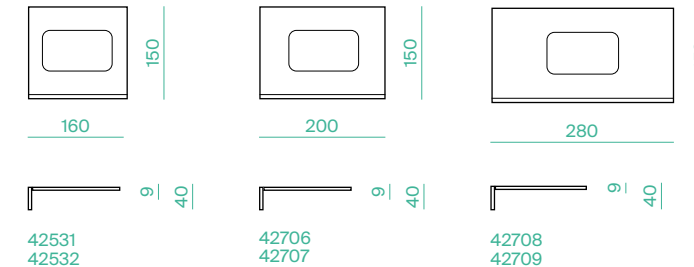

LOGICA

Lo spazio come protagonista

The space as the main actor

MINIMA è un apparecchio da parete che vuole allontanarsi da tutti gli abbellimenti e infrastrutture che non sono utili al suo scopo primario: emettere luce. È rimasto solo l'indispensabile, la sua ragion d'essere. La sua presenza impercettibile la rende un oggetto adatto a qualsiasi ambiente, dal più complesso al più semplice. MINIMA non vuole essere la protagonista dello spazio: vuole rendere protagonista lo spazio. La luce emessa è morbida, leggera e contribuisce a creare una delicata esperienza degli ambienti. La possibilità di modificare l'intensità luminosa unita alla sua silhouette la rendono un elemento altamente efficiente. Essenziale e versatile: le massime qualità di MINIMA.

MINIMA is a wall lighting fitting stripped of all those embellishments and structures which do not concern its core scope of emitting light. Only the indispensable parts remain, in other words just the ones that are related to the product purpose. Its imperceptible presence makes it an object suitable for any ambience, be it sophisticated or very simple. MINIMA doesn't aim to be the main actor in the space: it lets the space play the leading role. The light emitted is smooth, weightless and it contributes to create a delicate experience of the areas. The opportunity to modify the light output plus its simple silhouette make it an efficient element. Essential and versatile: MINIMA main features.



Essenzialità al massimo

Essentiality at its best

Il corpo di MINIMA prende forma da un'accurata lavorazione dell'alluminio dal pieno con tecnologia CNC; questo specifico processo produttivo permette di fornire un supporto dissipante ottimale. Il corpo ingloba all'interno una piastra LED dimmerabile a taglio di fase che, con l'aggiunta dell'interfaccia, può essere gestito con il sistema DALI.

MINIMA body stems from an accurate CNC process of the aluminium block. This specific working process guarantees an excellent heat sink. The body incorporates a phase dimming LED board which can be eventually connected to an interface which would also allow DALI control.



Grazie al suo spessore minimale, MINIMA è un oggetto adatto ad essere inserito in qualsiasi ambiente, dal più complesso al più semplice.

Thanks to its thin thickness, MINIMA is an object suitable to be installed in any environment, be it articulate or simple and essential interior designing.

Essential

Apparecchio per montaggio a parete
Corpo in alluminio lavorato dal pieno
Led integrato con dimmerazione a taglio di fase
Driver integrato

*Wall-bracket
Solid machined aluminum body
Integrated LED with phase-cut dimming
Built-in driver*



ESSENTIAL



LED LTWG
 CRI >90
 PF 0.9
 SDCM 3
 UGR <25

CODE	FINISHING	WATT	LUMEN	WATT LIGHT SOURCE	LUMEN LIGHT SOURCE	BEAM	KELVIN	MODE	KG
43170	Bianco/White	20W	1209	18,9W	1620	110°	3000K	Dimm. Taglio di fase/ Phase cut dimming	0,50
43171	Nero/Black	20W	1209	18,9W	1620	110°	3000K	Dimm. Taglio di fase/ Phase cut dimming	0,50
43172	Bianco/White	30W	1850	28,29W	2432	110°	3000K	Dimm. Taglio di fase/ Phase cut dimming	0,60
43173	Nero/Black	30W	1850	28,29W	2432	110°	3000K	Dimm. Taglio di fase/ Phase cut dimming	0,60

INSTALLAZIONE APPLICATION



Parete/Wall

DISEGNI TECNICI TECHNICAL DRAWINGS

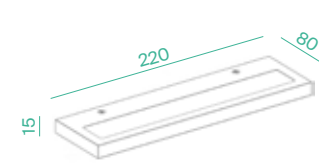

43170
43171

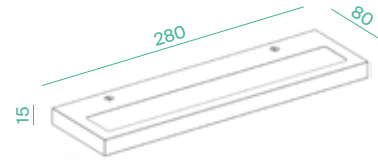

43172
43173





LED LUMINUS CXM-6
 CRI >90
 PF 0.9
 SDCM 3
 UGR <25

CODE	FINISHING	WATT	LUMEN	WATT LIGHT SOURCE	LUMEN LIGHT SOURCE	BEAM	KELVIN	KG
43174	Bianco/White	5W+5W	463+463	4,5W+4,5W	620+620	38°	3000K	0,70
43175	Nero/Black	5W+5W	463+463	4,5W+4,5W	620+620	38°	3000K	0,70

INSTALLAZIONE APPLICATION



Parete/Wall

DISEGNI TECNICI TECHNICAL DRAWINGS

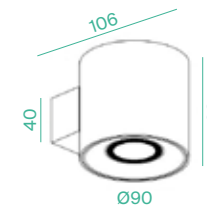

Apparecchio per montaggio a parete
 Led integrato
 Illuminazione diretta ed indiretta
 Corpo in alluminio lavorato dal pieno
 Driver integrato

*Wall-bracket for direct and indirect lighting
 Built-in LED
 Solid machined aluminum body
 Built-in driver*



Bloc_Evo

BLOC_EVO



LED SANAN
CRI >80
PF 0.5

CODE	FINISHING	WATT	LUMEN	WATT LIGHT SOURCE	LUMEN LIGHT SOURCE	KELVIN	DRIVER	KG
40617	Nero/Black	11W	804	9W	1200	3000K	300mA 22-40V	0,66
40615	Bianco/White	11W	804	9W	1200	3000K	300mA 22-40V	0,66



INSTALLAZIONE APPLICATION



Parete/Wall

DISEGNI TECNICI TECHNICAL DRAWINGS

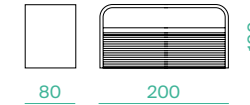

Apparecchio a parete LED integrato
Illuminazione diretta ed indiretta
Corpo in alluminio verniciato
Driver integrato

*Wall fitting with built-in LED
Direct and indirect lighting
Painted aluminium body
Built-in driver*



Dumbo



Luce testata letto led integrato con braccio flessibile
 Interruttore indipendente
 Corpo in acciaio cromato o verniciato nero
 Driver integrato

*Flexible built-in LED wall-light
 Independent switch
 Chrome or black painted steel body
 Built-in driver*

DUMBO FLEX



LED SEOUL SC
 CRI >80
 PF >0.5

CODE	FINISHING	WATT	LUMEN	WATT LIGHT SOURCE	LUMEN LIGHT SOURCE	KELVIN	DRIVER	VOLT	KG
42619	Nero/Black	3W	150	2,76W	154	3000K	700mA	6V	0,30
42620	Cromo/Chrome	3W	150	2,76W	154	3000K	700mA	6V	0,30

INSTALLAZIONE APPLICATION



Parete/Wall

DISEGNI TECNICI TECHNICAL DRAWINGS

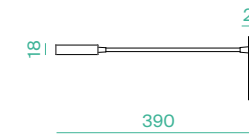

REGOLAZIONI ADJUSTABILITY



DUMBO

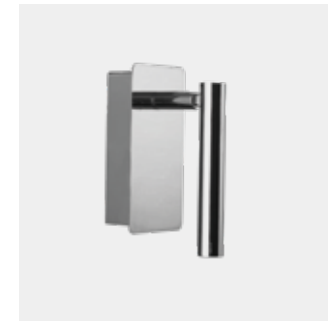

LED SEOUL SC
 CRI >80
 PF >0.5

CODE	FINISHING	WATT	LUMEN	WATT LIGHT SOURCE	LUMEN LIGHT SOURCE	KELVIN	DRIVER	VOLT	KG
42621	Nero/Black	3W	150	2,76W	154	3000K	700mA	6V	0,26
42622	Cromo/Chrome	3W	150	2,76W	154	3000K	700mA	6V	0,26

INSTALLAZIONE APPLICATION



Parete/Wall

DISEGNI TECNICI TECHNICAL DRAWINGS

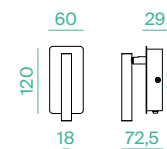

REGOLAZIONI ADJUSTABILITY





WALL INCASSO



CODE	FINISHING	DESCRIPRION	SIZE	KG
21388	Bianco/White	Profilo /Profile	2mt	1,65

INSTALLAZIONE APPLICATION



Incasso/Recessed

DISEGNI TECNICI TECHNICAL DRAWINGS

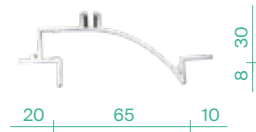

ONDA INCASSO



CODE	FINISHING	DESCRIPTION	SIZE	KG
21385	Bianco/White	Profilo / Profile	2mt	1,80

INSTALLAZIONE APPLICATION

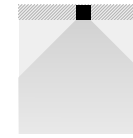

Incasso/Recessed

DISEGNI TECNICI TECHNICAL DRAWINGS

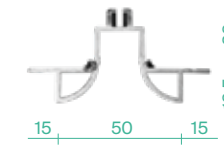

ACCESSORI ACCESSORIES



21301

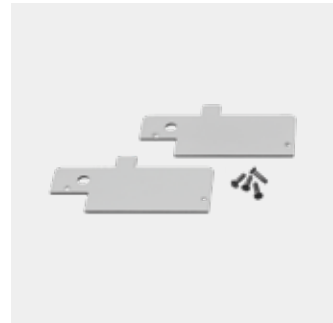

21389

CODE	FINISHING	DESCRIPTION	SIZE
21301	Opale/Opal	Schermo / Diffuser	2mt
21389	Bianco/White	Kit 4 viti + 2 testate di chiusura/ 4 screws + 2 end caps kit	

ACCESSORI ACCESSORIES

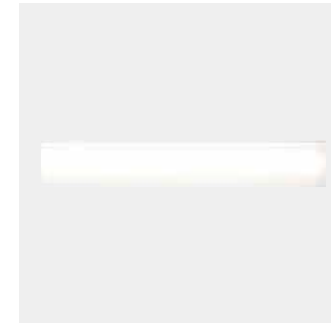

21387

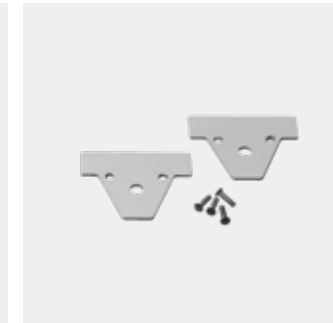

21386

CODE	FINISHING	DESCRIPTION	SIZE
21387	Opale/Opal	Schermo / Diffuser	2mt
21386	Bianco/White	Kit 4 viti + 2 testate di chiusura/ 4 screws + 2 end caps kit	

LINE_EVO SOFFITTO

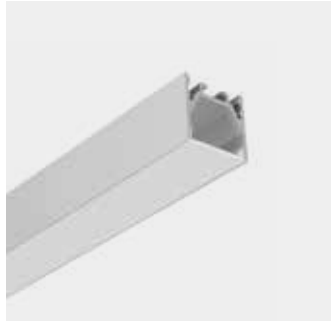

CODE	FINISHING	DESCRIPTION	SIZE	KG
11911	Alluminio/ Aluminium	Profilo / Profile	2mt	1,20
11912	Bianco/White	Profilo / Profile	2mt	1,20
11913	Nero/Black	Profilo / Profile	2mt	1,20
11923	Oro/Gold	Profilo / Profile	2mt	1,20

INSTALLAZIONE APPLICATION



Soffitto/Ceiling

DISEGNI TECNICI TECHNICAL DRAWINGS

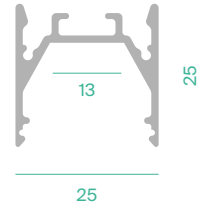

ACCESSORI ACCESSORIES

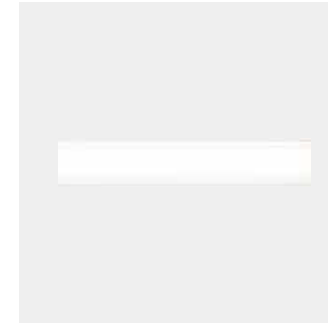

11914



11915

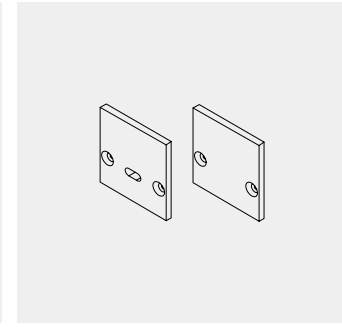

11916, 11917, 11918, 11924

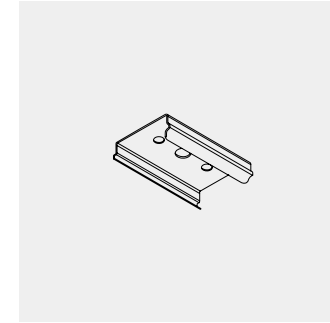

11919

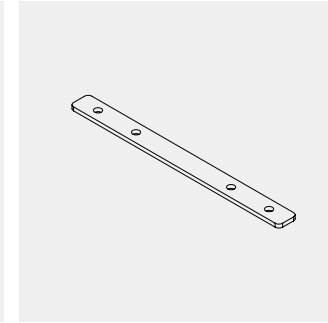

11920

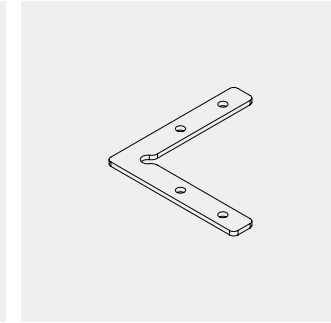

11921

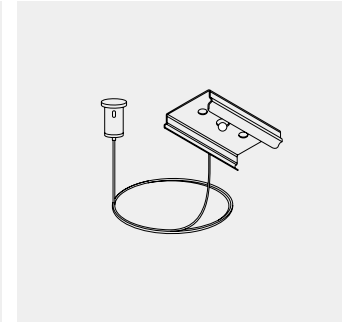

11922

CODE	FINISHING	DESCRIPTION	SIZE
11914	Opale/Opal	Schermo / Diffuser	2mt
11915	Nero/Black	Schermo / Diffuser	2mt
11916	Alluminio/ Aluminium	Kit 4 viti + 2 testate di chiusura/4 screws + 2 end caps kit	
11917	Bianco/White	Kit 4 viti + 2 testate di chiusura/4 screws + 2 end caps kit	
11918	Nero/Black	Kit 4 viti + 2 testate di chiusura/4 screws + 2 end caps kit	
11924	Oro/Gold	Kit 4 viti + 2 testate di chiusura/4 screws + 2 end caps kit	
11919	n/a	Kit 2 staffe per soffitto/2 ceiling fixing brackets kit	
11920	n/a	Congiunzione lineare/Linear junction	
11921	n/a	Congiunzione 90°/90° junction	
11922	n/a	Kit 2 sospensioni con cavo / 2 suspension kit with steel cable	3mt



LINE MINI SOFFITTO



CODE	FINISHING	DESCRIPTION	SIZE	KG
11925	Alluminio/Aluminium	Profilo + diffusore opale / Profile + opal diffuser	2mt	0,14

INSTALLAZIONE APPLICATION



Soffitto/Ceiling

DISEGNI TECNICI TECHNICAL DRAWINGS

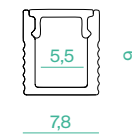

ACCESSORI ACCESSORIES



11926

11927

CODE	DESCRIPTION
11926	Kit testate di chiusura aperta e chiusa (2pz) / Open and closed end-cap (2 pcs)
11927	Kit clips di fissaggio (2pz) / Fixing brackets (2 pcs)

LINE DEEP INCASSO

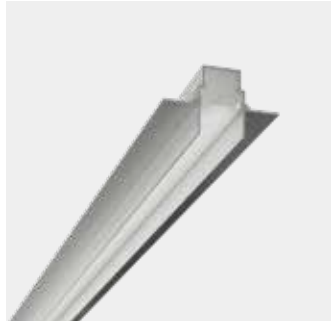

CODE	FINISHING	DESCRIPTION	SIZE	KG
11910	Bianco/White	Profilo / Profile	2mt	1,30

INSTALLAZIONE APPLICATION

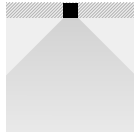

Incasso/Recessed

DISEGNI TECNICI TECHNICAL DRAWINGS

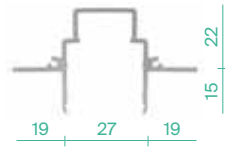

ACCESSORI ACCESSORIES



21303



21304

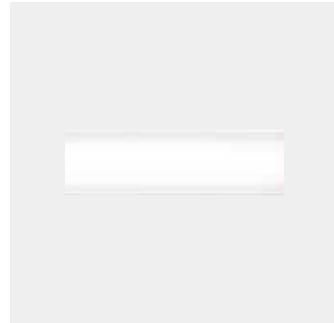

21305

CODE	FINISHING	DESCRIPTION	SIZE
21303	Trasparente/ Transparent	Schermo / Diffuser	2mt
21304	Satinato/Frosted	Schermo / Diffuser	2mt
21305	Opale/Opal	Schermo / Diffuser	2mt

LINE INCASSO



CODE	FINISHING	DESCRIPTION	SIZE	KG
11906	Alluminio/Aluminum	Profilo / Profile	2mt	1,30

INSTALLAZIONE APPLICATION

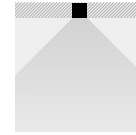

Incasso/Recessed

DISEGNI TECNICI TECHNICAL DRAWINGS

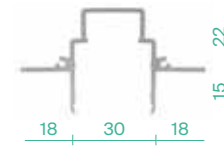

ACCESSORI ACCESSORIES

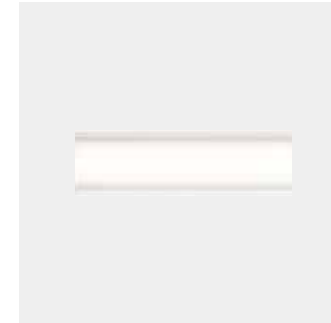

11675

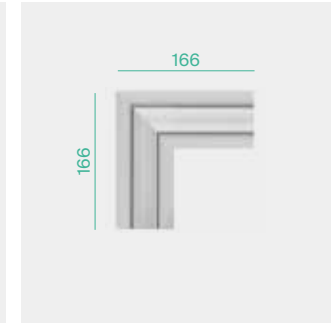

13570

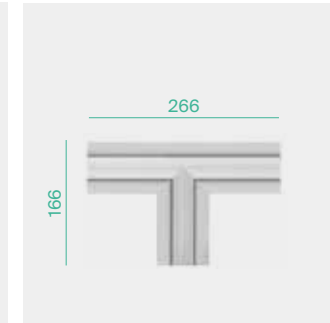

13571

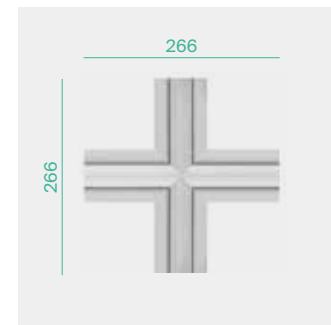

13572

CODE	FINISHING	DESCRIPTION	SIZE
11675	Satinato-opale/ Opal-frosted	Schermo / Diffuser	2mt
13570	Alluminio/ Aluminium	Giunto "L"/L-Joint	
13571	Alluminio/ Aluminium	Giunto "T"/T-Joint	
13572	Alluminio/ Aluminium	Giunto "X"/X-Joint	

DOUBLE SOFFITTO



CODE	FINISHING	DESCRIPTION	SIZE	KG
21472	Alluminio/Aluminium	Profilo / Profile	2mt	0,30
21473	Bianco/White	Profilo / Profile	2mt	0,30

INSTALLAZIONE APPLICATION

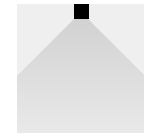

Soffitto/Ceiling

DISEGNI TECNICI TECHNICAL DRAWINGS

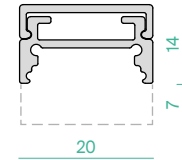

ACCESSORI ACCESSORIES



21476 - 21477

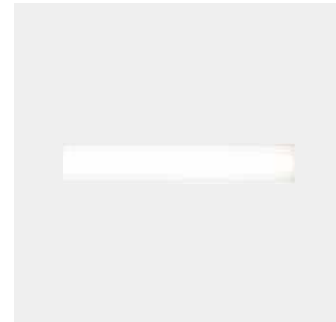

21474

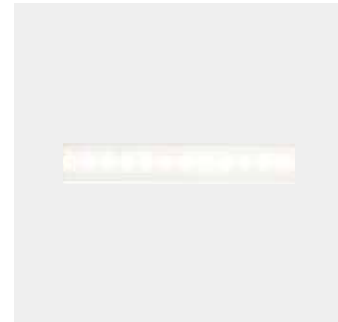

21475

CODE	FINISHING	DESCRIPTION	SIZE
21474	Opale/Opal	Schermo / Diffuser	2mt
21475	Satinato/Frosted	Schermo / Diffuser	2mt
21476	Alluminio/Aluminium	Kit 4 viti + 2 testate / 4 screws + 2 end caps kit	
21477	Bianco/White	Kit 4 viti + 2 testate / 4 screws + 2 end caps kit	

PR1 SOFFITTO



CODE	FINISHING	DESCRIPTION	SIZE	KG
21048	Alluminio/Aluminium	Profilo / Profile	2mt	0,20
21376	Bianco/White	Profilo / Profile	2mt	0,20

INSTALLAZIONE APPLICATION

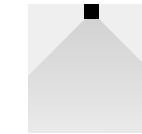

Soffitto/Ceiling

DISEGNI TECNICI TECHNICAL DRAWINGS



PR1_DEEP SOFFITTO



CODE	FINISHING	DESCRIPTION	SIZE	KG
21494	Alluminio/Aluminium	Profilo / Profile	2mt	0,40
21495	Bianco/White	Profilo / Profile	2mt	0,40

INSTALLAZIONE APPLICATION

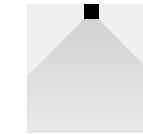

Soffitto/Ceiling

DISEGNI TECNICI TECHNICAL DRAWINGS

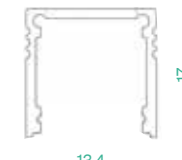

ACCESSORI ACCESSORIES



21052

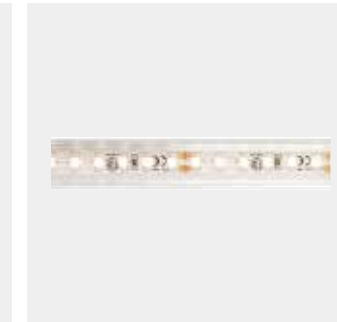

21051



21301



21053 - 21378

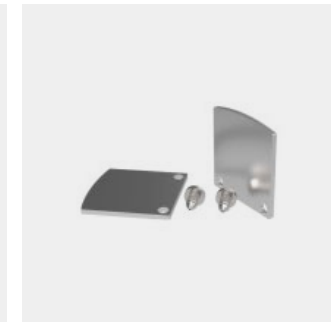

21496 - 21497



21054 - 21379

CODE	FINISHING	DESCRIPTION	SIZE
21052	Satinato/Frosted	Schermo per PR1, PR1_DEEP/ Diffuser for PR1, PR1_DEEP	2mt
21051	Trasparente/Transparent	Schermo per PR1, PR1_DEEP/ Diffuser for PR1, PR1_DEEP	2mt
21301	Opale/Opal	Schermo per PR1, PR1_DEEP/ Diffuser for PR1, PR1_DEEP	2mt
21053	Alluminio/Aluminium	Kit 4 viti + 2 testate per PR1 / 4 screws + 2 end caps kit for PR1	
21378	Bianco/White	Kit 4 viti + 2 testate per PR1 / 4 screws + 2 end caps kit for PR1	
21496	Alluminio/Aluminium	Kit 4 viti + 2 testate per PR1_DEEP / 4 screws + 2 end caps kit for PR1_DEEP	
21497	Bianco/White	Kit 4 viti + 2 testate per PR1_DEEP / 4 screws + 2 end caps kit for PR1_DEEP	
21054	Alluminio/Aluminium	Kit 2 staffe fissaggio per PR1, PR1_DEEP/ 2 fixing brackets kit for PR1, PR1_DEEP	
21379	Bianco/White	Kit 2 staffe fissaggio per PR1, PR1_DEEP/ 2 fixing brackets kit for PR1, PR1_DEEP	

PR2 INCASSO



PR2_DEEP INCASSO



CODE	FINISHING	DESCRIPTION	SIZE	KG	CODE	FINISHING	DESCRIPTION	SIZE	KG
21049	Alluminio/ Aluminium	Profilo / Profile	2mt	0,22	21498	Alluminio/ Aluminium	Profilo / Profile	2mt	0,44
21377	Bianco/White	Profilo / Profile	2mt	0,22	21499	Bianco/White	Profilo / Profile	2mt	0,44

INSTALLAZIONE APPLICATION

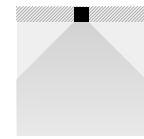

Incasso/Recessed

DISEGNI TECNICI TECHNICAL DRAWINGS

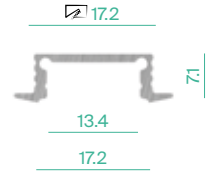

INSTALLAZIONE APPLICATION

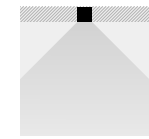

Incasso/Recessed

DISEGNI TECNICI TECHNICAL DRAWINGS

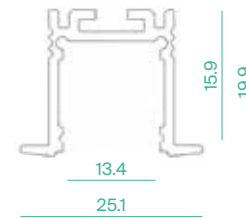

ACCESSORI ACCESSORIES

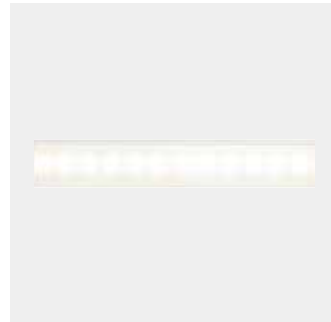

21052



21051



21301



21053 - 21378



21496 - 21497



21054 - 21379



21500

CODE	FINISHING	DESCRIPTION	SIZE
21052	Satinato/Frosted	Schermo per PR2, PR2_DEEP/ Diffuser for PR2, PR2_DEEP	2mt
21051	Trasparente/ Transparent	Schermo per PR2, PR2_DEEP/ Diffuser for PR2, PR2_DEEP	2mt
21301	Opale/Opal	Schermo per PR2, PR2_DEEP/ Diffuser for PR2, PR2_DEEP	2mt
21053	Alluminio/Aluminium	Kit 4 viti + 2 testate per PR2/ 4 screws + 2 end caps kit for PR2	
21378	Bianco/White	Kit 4 viti + 2 testate per PR2/ 4 screws + 2 end caps kit for PR2	
21496	Alluminio/Aluminium	Kit 4 viti + 2 testate per PR2_DEEP/ 4 screws + 2 end caps kit for PR2_DEEP	
21497	Bianco/White	Kit 4 viti + 2 testate per PR2_DEEP/ 4 screws + 2 end caps kit for PR2_DEEP	
21054	Alluminio/Aluminium	Kit 2 staffe fissaggio per PR2, PR2_DEEP/ 2 fixing brackets kit for PR2, PR2_DEEP	
21379	Bianco/White	Kit 2 staffe fissaggio per PR2, PR2_DEEP/ 2 fixing brackets kit for PR2, PR2_DEEP	
21500	n/a	Molla per PR2_DEEP 2pz/Spring for PR2_DEEP 2pcs	

PR3_EVO ANGOLO

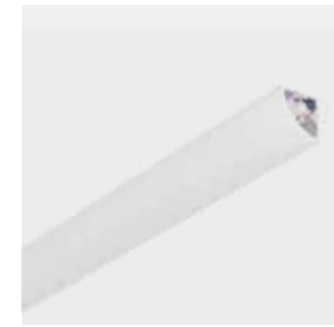

CODE	FINISHING	DESCRIPTION	SIZE	KG
21440	Alluminio/ Aluminium	Profilo / Profile	2mt	0,30
21441	Bianco/White	Profilo / Profile	2mt	0,30

INSTALLAZIONE APPLICATION



Angolo/Corner

DISEGNI TECNICI TECHNICAL DRAWINGS

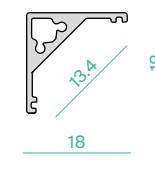

ACCESSORI ACCESSORIES

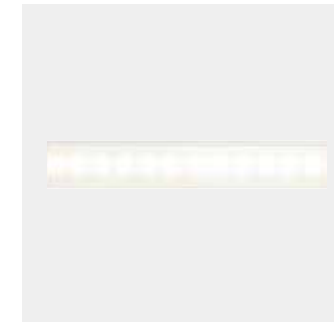

21442



21443

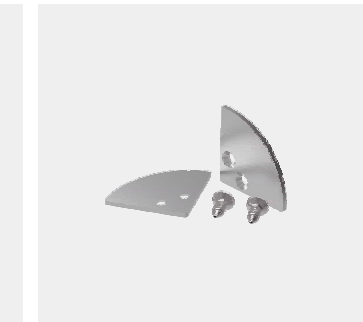

21444 - 21445



21446 - 21447

CODE	FINISHING	DESCRIPTION	SIZE
21442	Satinato/Frosted	Schermo / Diffuser	2mt
21443	Opale/Opal	Schermo / Diffuser	2mt
21444	Alluminio/Aluminium	Kit 4 viti + 2 testate per PR3 EVO/4 screws + 2 end caps kit for PR3 EVO	
21445	Bianco/White	Kit 4 viti + 2 testate per PR3 EVO/4 screws + 2 end caps kit for PR3 EVO	
21446	Alluminio/Aluminium	Kit 2 staffe fissaggio per PR3 EVO/2 fixing brackets kit for PR3 EVO	
21447	Bianco/White	Kit 2 staffe fissaggio per PR3 EVO/2 fixing brackets kit for PR3 EVO	

RECHARGEABLE

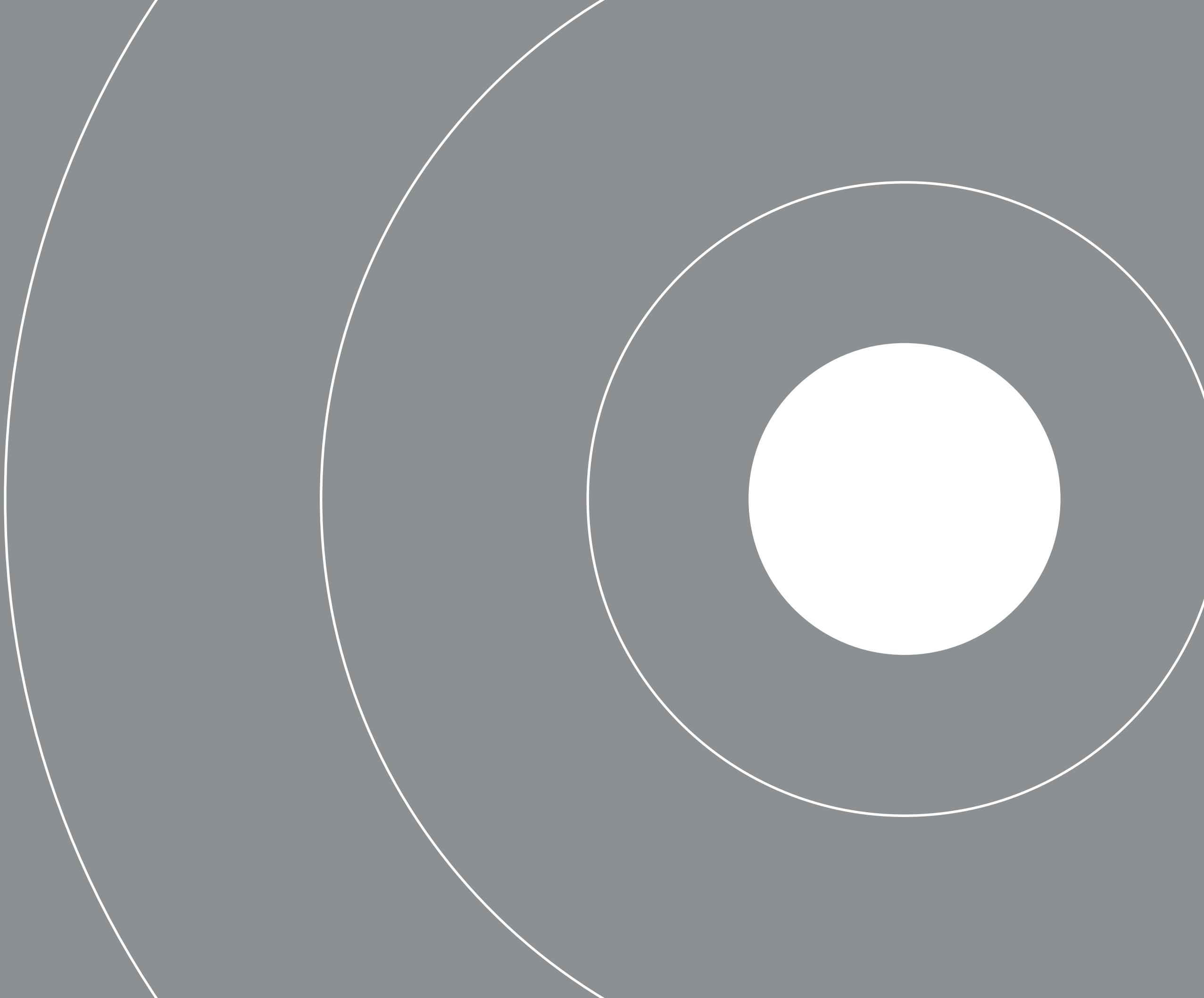

Regolazione temperatura colore

Colour temperature setting

Il CCT definisce l'apparenza del colore prodotto da una sorgente a LED bianca e viene misurato in gradi Kelvin. In altre parole, se una luce appare più gialla - warm - oppure blu - cool. Più alti sono i gradi Kelvin, più la luce sarà tendente al blu. Le nostre lampade implementano una tecnologia LED di regolazione che permette di scegliere tra 2700K e 3000K, per una personalizzazione massima a seconda dello spazio e dei gusti personali.

CCT stands for Correlated Colour Temperature and it defines the colour appearance of a white LED. CCT is defined in degrees Kelvin. To make it simpler, a yellow light is "warm" while a more bluish one is "cool". A warm light is around 2700K and the more we go up (4000K - 5000K..) we move towards a cooler light. Our lamps have all got a selectable CCT (either 2700K or 3000K) in order to adapt to the environment or to satisfy the personal taste.



Warm white
2700K

Soft white
3000K





DIMMERABILITÀ FLESSIBILE

Le lampade ricaricabili offrono flessibilità e praticità. Con la funzione di dimmerabilità stepless, consentono un controllo preciso dell'intensità luminosa, adattandosi alle diverse esigenze.

STEPLESS DIMMING

Rechargeable lamps offer flexibility and convenience. With the stepless dimming function, they allow precise control of the light intensity, adapting to various needs.



RESISTENTE ALL'ESTERNO

La nostra gamma di lampade ricaricabili è progettata con certificazione IP67 per resistere all'esterno. Con la massima protezione contro acqua e polvere, queste lampade sono l'ideale per ogni momento conviviale.

OUTDOOR RESISTANT

Our range of rechargeable lamps is designed with IP67 certification to withstand outdoor use. With maximum protection against water and dust, these lamps are perfect for any social gathering.

Twiggy_Less



Lampada ricaricabile con sistema di ricarica wireless
Regolazione T° colore (2700°K - 3000°K)
Illuminazione a LED dimmerabile
Autonomia 9h

*Rechargeable lamp through wireless base.
Selectable colour temperature (2700°K or 3000°K)
Dimmable LED light
9h autonomy*



LOGICA



-  Nero
Matt black
-  Bianco
Matt white
-  Sabbia
Sand
-  Rosso Rubino
Ruby Red
-  Arancione
Orange
-  Antracite
Dark gray
-  Corten
-  Verde Salvia
Sage Green
-  Blu Oceano
Ocean Blue

TWIGGY_LESS



LED OSRAM
CRI >80

Ricarica con base di appoggio wireless con alimentatore (compreso)
Charging through wireless base with charger (included)

CODE	FINISHING	WATT	LUMEN	WATT LIGHT SOURCE	LUMEN LIGHT SOURCE	BEAM	KELVIN	KG
42753	Antracite/Anthracite	2.2W	150	1.8W	217	100°	2700/3000K	0,85
42754	Bianco/White	2.2W	150	1.8W	217	100°	2700/3000K	0,85
42755	Nero/Black	2.2W	150	1.8W	217	100°	2700/3000K	0,85
42756	Corten	2.2W	150	1.8W	217	100°	2700/3000K	0,85
42757	Giallo/Yellow	2.2W	150	1.8W	217	100°	2700/3000K	0,85
42758	Arancione/Orange	2.2W	150	1.8W	217	100°	2700/3000K	0,85
42759	Verde Salvia/ Sage Green	2.2W	150	1.8W	217	100°	2700/3000K	0,85
42760	Blu Avio	2.2W	150	1.8W	217	100°	2700/3000K	0,85
42761	Sabbia/Sand	2.2W	150	1.8W	217	100°	2700/3000K	0,85
42820	Rosso Rubino/ Ruby Red	2.2W	150	1.8W	217	100°	2700/3000K	0,85

INSTALLAZIONE APPLICATION

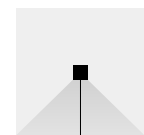

Appoggio/Standing

DISEGNI TECNICI TECHNICAL DRAWINGS

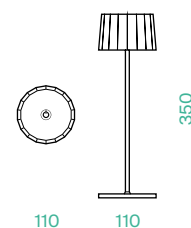

La garanzia fornita dalla casa sulla batteria è di 12 mesi
/Manufacturer's warranty on battery is 12 months

ACCESSORI ACCESSORIES

CODE	DESCRIPTION	ALIMENTAZIONE/AC-DC ADAPTOR
11654	Base ricarica multipla x6 lampade Multiple charger x6 lamps	100-240V 50/60Hz 9VDC 5A 45W

DISEGNI TECNICI TECHNICAL DRAWINGS

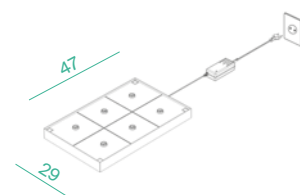

Base per ricarica multipla

Questo sistema permette la ricarica multipla di 6 lampade (TWIGGY_LESS and ZEN) nello stesso momento. Grazie ai quattro supporti è possibile sovrapporre fino a tre basi per un massimo di 18 lampade in carica contemporaneamente.

Multiple induction charging base

This system allows the multiple charging of 6 lamps (TWIGGY_LESS - ZEN) at the same time. Thanks to the four supports, it's also possible to have up to three shelves being recharged so that a total of 18 lamps can be recharged at the same time.

Diogene



Lampada ricaricabile con cavo micro USB
Illuminazione a LED dimmerabile
Regolazione T° colore (2700°K - 3000°K)
Autonomia 9h

*Rechargeable lamp by micro USB cable.
Dimmable LED light
Selectable colour temperature (2700°K or 3000°K)
9h autonomy*



DIogene



LED OSRAM
CRI >80

Ricarica con cavo USB-C con alimentatore (compreso)
Charging through USB-C cable with charger (included)

CODE	FINISHING	WATT	LUMEN	WATT LIGHT SOURCE	LUMEN LIGHT SOURCE	BEAM	KELVIN	KG
42720	Antracite/Anthracite	2.2W	200	1.8W	205	120°	2700/3000K	1,60
42721	Bianco/White	2.2W	200	1.8W	205	120°	2700/3000K	1,60
42722	Nero/Black	2.2W	200	1.8W	205	120°	2700/3000K	1,60
42723	Corten	2.2W	200	1.8W	205	120°	2700/3000K	1,60
42762	Sabbia/Sand	2.2W	200	1.8W	205	120°	2700/3000K	1,60

INSTALLAZIONE APPLICATION



Appoggio/Standing

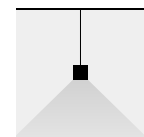

Sospesa/Hanging

DISEGNI TECNICI TECHNICAL DRAWINGS

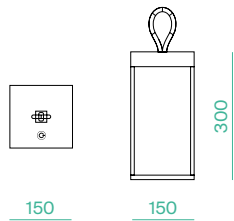

La garanzia fornita dalla casa sulla batteria è di 12 mesi /
Manufacturer's warranty on battery is 12 months

DIogene L



LED OSRAM
CRI >80

Ricarica con cavo USB-C con alimentatore (compreso)
Charging through USB-C cable with charger (included)

CODE	FINISHING	WATT	LUMEN	WATT LIGHT SOURCE	LUMEN LIGHT SOURCE	BEAM	KELVIN	KG
42724	Antracite/Anthracite	2.2W	200	1.8W	205	120°	2700/3000K	1,80
42725	Bianco/White	2.2W	200	1.8W	205	120°	2700/3000K	1,80
42726	Nero/Black	2.2W	200	1.8W	205	120°	2700/3000K	1,80
42727	Corten	2.2W	200	1.8W	205	120°	2700/3000K	1,80
42763	Sabbia/Sand	2.2W	200	1.8W	205	120°	2700/3000K	1,80

INSTALLAZIONE APPLICATION

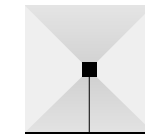

Appoggio/Standing

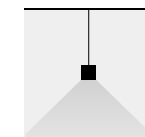

Sospesa/Hanging

DISEGNI TECNICI TECHNICAL DRAWINGS

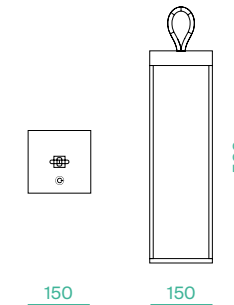

La garanzia fornita dalla casa sulla batteria è di 12 mesi /
Manufacturer's warranty on battery is 12 months

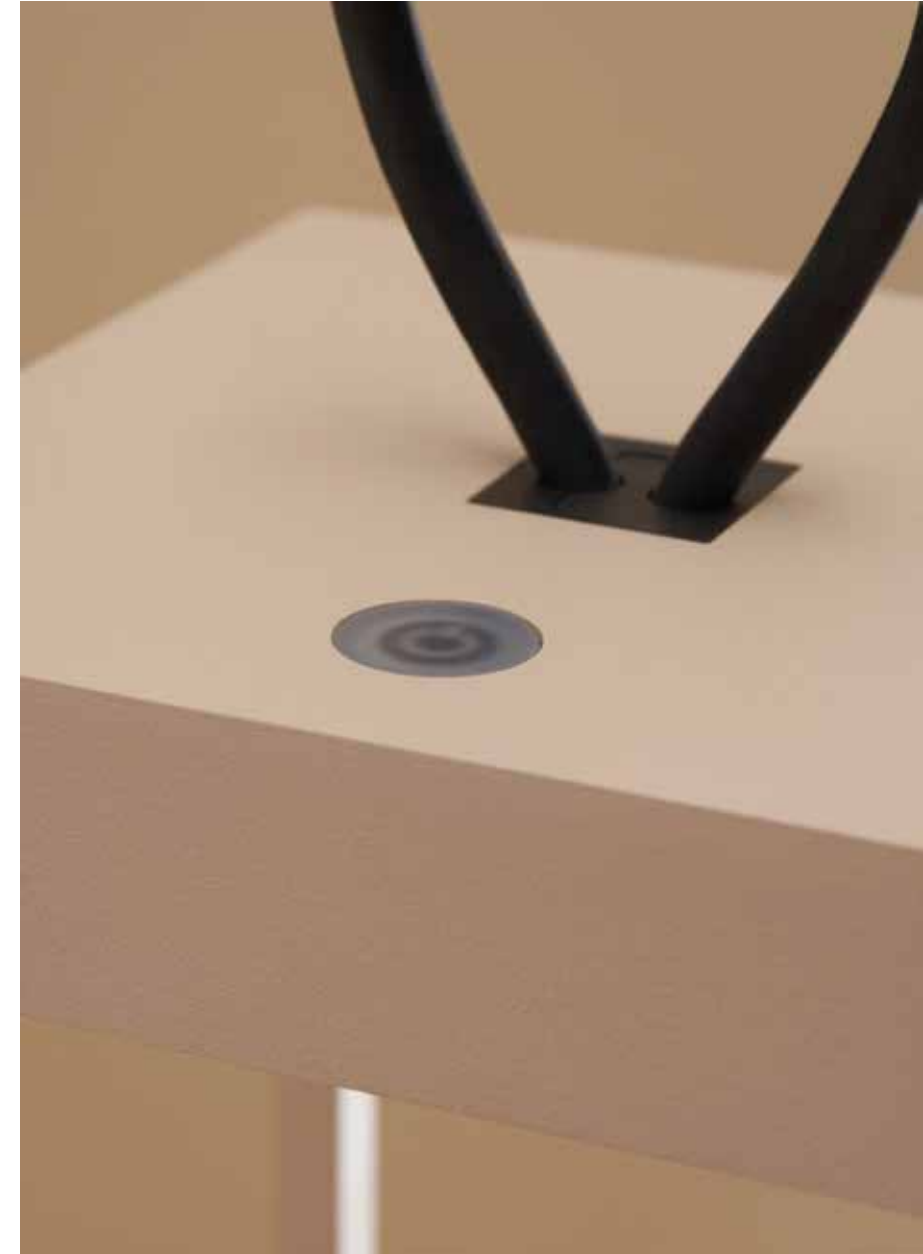

-  Nero
Matt black
-  Bianco
Matt white
-  Sabbia
Sand
-  Antracite
Dark gray
-  Corten

Iota



Lampada ricaricabile con cavo micro USB
Illuminazione a LED dimmerabile
Regolazione T° colore (2700°K - 3000°K)
Autonomia 9h

*Rechargeable lamp by micro USB cable.
Dimmable LED light
Selectable colour temperature (2700°K or 3000°K)
9h autonomy*





- Nero
Matt black
- Bianco
Matt white
- Sabbia
Sand
- Rosso Rubino
Ruby Red
- Antracite
Dark gray
- Corten
- Verde Salvia
Sage Green
- Blu Oceano
Ocean Blue

IOTA



LED OSRAM
CRI >80

Ricarica con cavo USB-C
con alimentatore (compreso)
Charging through USB-C cable
with charger (included)

CODE	FINISHING	WATT	LUMEN	WATT LIGHT SOURCE	LUMEN LIGHT SOURCE	BEAM	KELVIN	KG
42800	Antracite/ Dark Grey	2.5W	120	1.8W	200	120°	2700/3000K	0,75
42801	Bianco/ Matt White	2.5W	120	1.8W	200	120°	2700/3000K	0,75
42802	Nero/Matt Black	2.5W	120	1.8W	200	120°	2700/3000K	0,75
42803	Sabbia/Sand	2.5W	120	1.8W	200	120°	2700/3000K	0,75
42804	Rosso Rubino/ Ruby Red	2.5W	120	1.8W	200	120°	2700/3000K	0,75
42805	Verde Salvia/ Sage Green	2.5W	120	1.8W	200	120°	2700/3000K	0,75
42806	Blu Oceano/ Ocean Blue	2.5W	120	1.8W	200	120°	2700/3000K	0,75
42807	Corten	2.5W	120	1.8W	200	120°	2700/3000K	0,75

INSTALLAZIONE APPLICATION

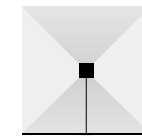

Appoggio/Standing

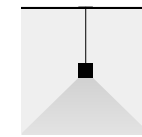

Sospesa/Hanging

DISEGNI TECNICI TECHNICAL DRAWINGS

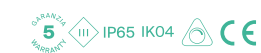
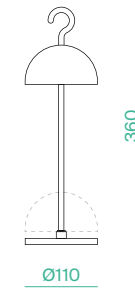

La garanzia fornita dalla casa sulla batteria è di 12 mesi /
Manufacturer's warranty on battery is 12 months

LOGICA

Zen



Lampada ricaricabile con sistema di ricarica wireless
Regolazione T° colore (2700°K - 3000°K)
Illuminazione a LED dimmerabile
Autonomia 9h

*Rechargeable lamp through wireless base.
Selectable colour temperature (2700°K or 3000°K)
Dimmable LED light
9h autonomy*





- Grigio Siderale
Space Gray
- Cromo
Chrome
- Bianco
Matt white
- Sabbia
Sand

ZEN

LED OSRAM
CRI >80

Ricarica con base di appoggio wireless
con alimentatore (compreso) /
Charging through wireless base
with charger (included)



CODE	FINISHING	WATT	LUMEN	WATT LIGHT SOURCE	LUMEN LIGHT SOURCE	BEAM	KELVIN	KG
42794	Bianco/ Matt White	2.5W	120	1.7W	206	120°	2700/3000K	0,55
42795	Sabbia/Sand	2.5W	120	1.7W	206	120°	2700/3000K	0,55
42796	Cromo/Chrome	2.5W	120	1.7W	206	120°	2700/3000K	0,55
42799	Grigio Siderale/ Space Grey	2.5W	120	1.7W	206	120°	2700/3000K	0,55

INSTALLAZIONE APPLICATION

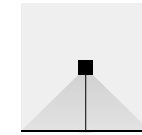

Appoggio/Standing

DISEGNI TECNICI TECHNICAL DRAWINGS

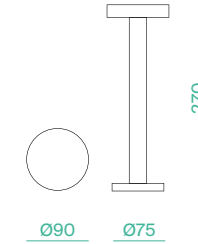

La garanzia fornita dalla casa sulla batteria è di 12 mesi /
Manufacturer's warranty on battery is 12 months

ACCESSORI ACCESSORIES

CODE	DESCRIPTION	ALIMENTAZIONE/AC-DC ADAPTOR
11654	Base ricarica multipla x6 lampade Multiple charger x6 lamps	100-240V 50/60Hz 9VDC 5A 45W

DISEGNI TECNICI TECHNICAL DRAWINGS

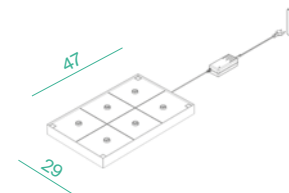

LOGICA

OUTDOOR

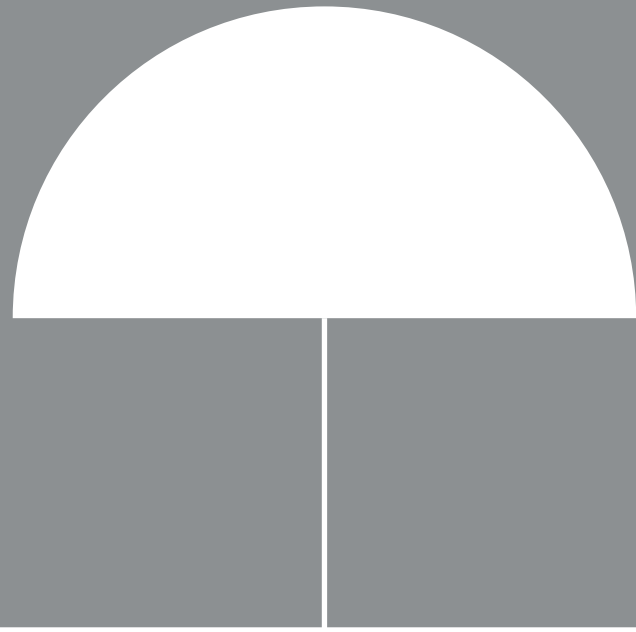
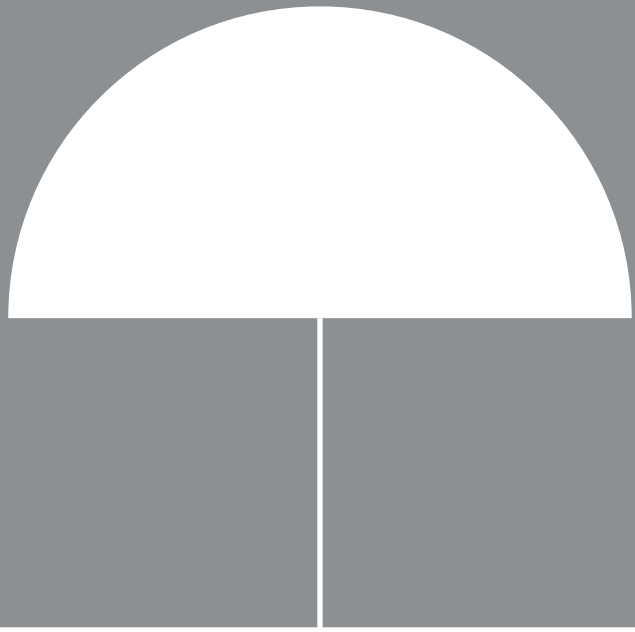

Slice



Apparecchio LED integrato bi-emissione
Corpo in alluminio estruso verniciato
Driver integrato

*Integrated bi-emission LED fitting
Painted extruded aluminum body
Integrated driver*

SLICE PARETE



LED BRIDGELUX
CRI >80
PF >0.5

CODE	FINISHING	WATT	LUMEN	WATT LIGHT SOURCE	LUMEN LIGHT SOURCE	BEAM	KELVIN	KG
41292	Bianco/White	3,5W+3,5W	263+263	2,9W+ 2,9W	360+360	90°	3000K	0,36
41293	Bianco/White	5W+5W	343+343	4,6W+ 4,6W	500+500	90°	3000K	0,51
41290	Nero/Black	3,5W+3,5W	263+263	2,9W+ 2,9W	360+360	90°	3000K	0,36
41291	Nero/Black	5W+5W	343+343	4,6W+ 4,6W	500+500	90°	3000K	0,51

INSTALLAZIONE APPLICATION



Parete/Wall

DISEGNI TECNICI TECHNICAL DRAWINGS

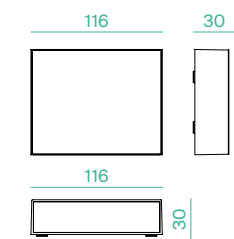

41292
41290

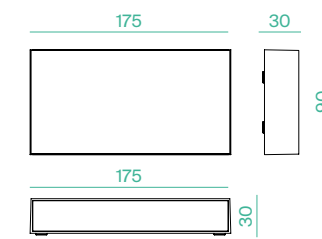

41293
41291



LOGICA

Titano_Evo



Apparecchio LED integrato monoemissione e bi-emissione
Corpo in alluminio pressofuso verniciato e ottica brillantata
Driver integrato

*Built-in LED single and double-sided emission
Painted die-cast aluminium body with multifaceted reflector
Built-in driver*

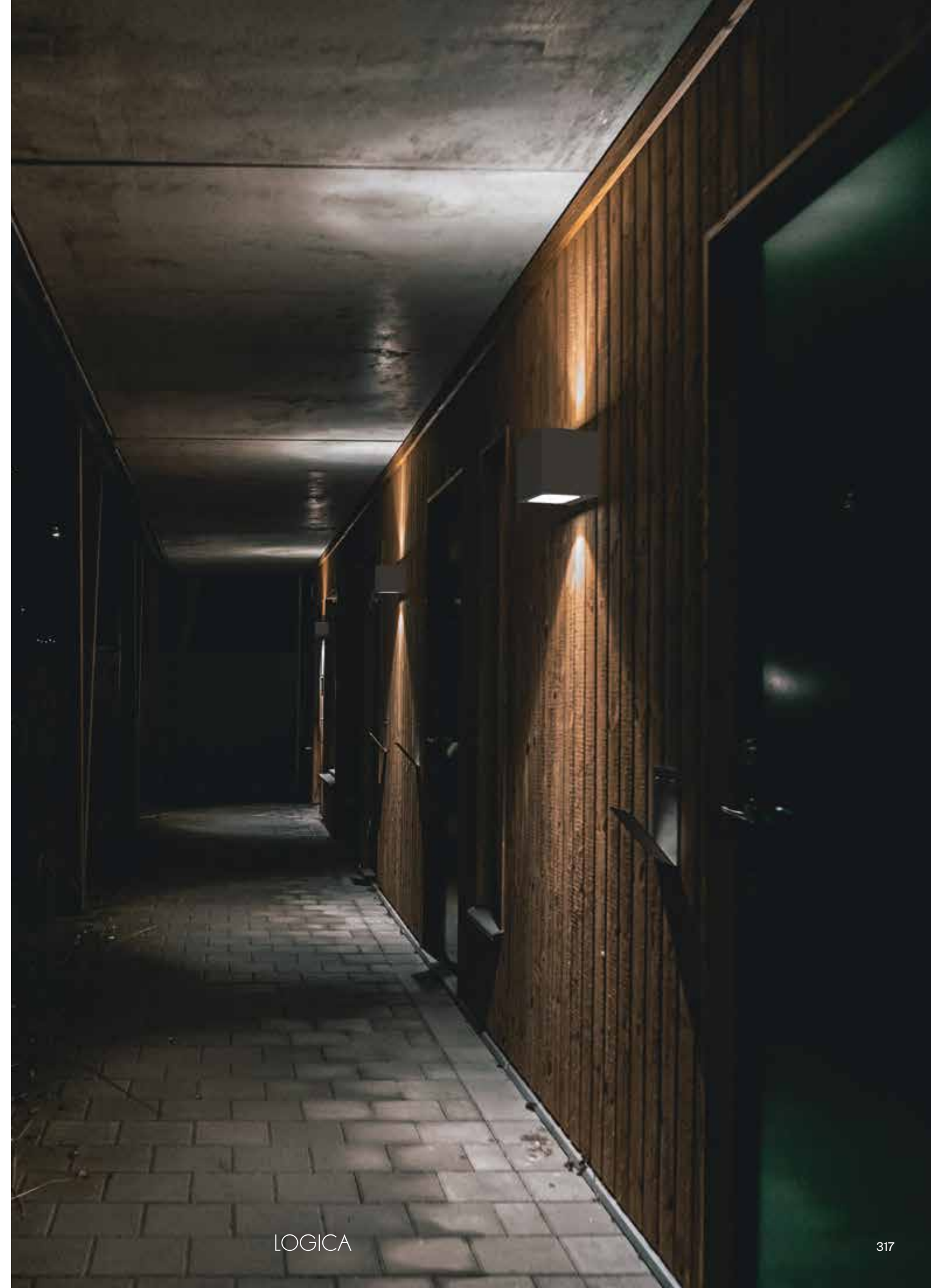

TITANO EVO PARETE MONO-EMISSIONE



LED EDISON
CRI >80
PF 0.54 (6W)
0.91 (10W)

CODE	FINISHING	WATT	LUMEN	WATT LIGHT SOURCE	LUMEN LIGHT SOURCE	BEAM	KELVIN	DRIVER	KG
43126	Bianco/White	6W	300	4,6W	437	45°	3000K	500mA, 23V	0,85
43130	Antracite/ Anthracite	6W	300	4,6W	437	45°	3000K	500mA, 23V	0,85
43127	Bianco/White	6W	310	4,7W	448	45°	5000K	500mA, 23V	0,85
43131	Antracite/ Anthracite	6W	310	4,7W	448	45°	5000K	500mA, 23V	0,85
43128	Bianco/White	10W	700	9W	811	60°	3000K	250mA, 58V	1,4
43132	Antracite/ Anthracite	10W	700	9W	811	60°	3000K	250mA, 58V	1,4
43129	Bianco/White	10W	720	9,1W	834	60°	5000K	250mA, 58V	1,4
43133	Antracite/ Anthracite	10W	720	9,1W	834	60°	5000K	250mA, 58V	1,4

INSTALLAZIONE APPLICATION



Parete/Wall

DISEGNI TECNICI TECHNICAL DRAWINGS

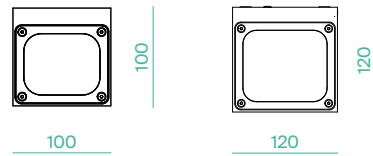

43126
43127
43130
43131

43128
43129
43132
43133

TITANO EVO PARETE BI-EMISSIONE



LED EDISON
CRI >80
PF 0.57 (2X6W)
0.92 (2X10W)

CODE	FINISHING	WATT	LUMEN	WATT LIGHT SOURCE	LUMEN LIGHT SOURCE	BEAM	KELVIN	DRIVER	KG
43134	Bianco / White	6W+6W	300+ 300	4,6W+ 4,6W	437+437	45°	3000K	500mA, 24V 30V	0,93
43138	Antracite / Anthracite	6W+6W	300+ 300	4,6W+ 4,6W	437+437	45°	3000K	500mA, 24V 30V	0,93
43135	Bianco / White	6W+6W	310+ 310	4,7W+ 4,7W	448+448	45°	5000K	500mA, 24V 30V	0,93
43139	Antracite / Anthracite	6W+6W	310+ 310	4,7W+ 4,7W	448+448	45°	5000K	500mA, 24V 30V	0,93
43136	Bianco / White	10W+10W	700+ 700	9W+9W	811+811	60°	3000K	250mA, 98V	1,6
43140	Antracite / Anthracite	10W+10W	700+ 700	9W+9W	811+811	60°	3000K	250mA, 98V	1,6
43137	Bianco/ White	10W+10W	720+ 720	9,1W+9,1W	834+834	60°	5000K	250mA, 98V	1,6
43143	Antracite/ Anthracite	10W+10W	720+ 720	9,1W+9,1W	834+834	60°	5000K	250mA, 98V	1,6

INSTALLAZIONE APPLICATION



Parete/Wall

DISEGNI TECNICI TECHNICAL DRAWINGS

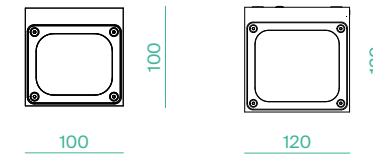

43134
43135
43138
43139

43136
43137
43140
43143

TITANO EVO PALO



Corpo luminoso non incluso
Lighting source not included

CODE	FINISHING	DESCRIPTION	SIZE	KG
40580	Antracite/ Anthracite	Accessorio c/griglie antiabbagliamento/ Accessory with anti-glaring grid	120x120x580	2,20
40579	Antracite/ Anthracite	Accessorio c/griglie antiabbagliamento/ Accessory with anti-glaring grid	100x100x500	1,40

INSTALLAZIONE APPLICATION



Terra/Floor

DISEGNI TECNICI TECHNICAL DRAWINGS

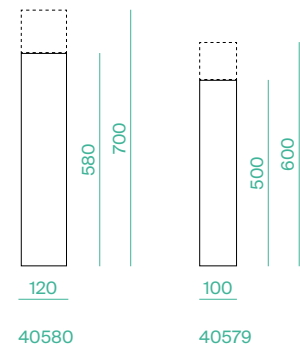

TITANO EVO SOFFITTO



LED EDISON
CRI >80
PF 0.54 (6W)
0.91 (10W)

CODE	FINISHING	WATT	LUMEN	WATT LIGHT SOURCE	LUMEN LIGHT SOURCE	BEAM	KELVIN	DRIVER	KG
43144	Bianco/ White	6W	300	4,6W	437	45°	3000K	500mA, 23V	0,85
43148	Antracite/ Anthracite	6W	300	4,6W	437	45°	3000K	500mA, 23V	0,85
43145	Bianco/ White	6W	310	4,7W	448	45°	5000K	500mA, 23V	0,85
43149	Antracite/ Anthracite	6W	310	4,7W	448	45°	5000K	500mA, 23V	0,85
43146	Bianco/ White	10W	700	9W	811	60°	3000K	250mA, 58V	1,40
43150	Antracite/ Anthracite	10W	700	9W	811	60°	3000K	250mA, 58V	1,40
43147	Bianco/ White	10W	720	9,1W	834	60°	5000K	250mA, 58V	1,40
43151	Antracite/ Anthracite	10W	720	9,1W	834	60°	5000K	250mA, 58V	1,40

INSTALLAZIONE APPLICATION



Soffitto/Ceiling

DISEGNI TECNICI TECHNICAL DRAWINGS

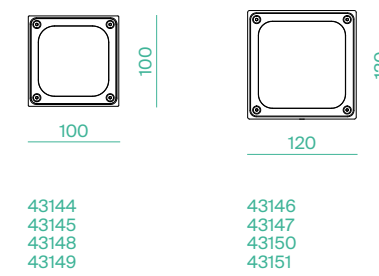

3 YEAR WARRANTY LED IP54 IK08 230V 50/60Hz CE

Moonlight



Apparecchio a parete e terra LED integrato in alluminio estruso
Driver integrato

*Built-in LED wall-bracket and floor in extruded aluminium
Built-in driver*



LOGICA

MOONLIGHT PALO



LED RF2835
CRI 80
PF 0.9

CODE	FINISHING	WATT	LUMEN	WATT LIGHT SOURCE	LUMEN LIGHT SOURCE	BEAM	KELVIN	DRIVER	KG
41167	Antracite/ Anthracite	10W	700	9,5W	1200	90°	3000K	250VDC/ 32mA	1,30
41168	Antracite/ Anthracite	15W	1050	14,5W	1650	90°	3000K	250VDC/ 48mA	1,60
41169	Antracite/ Anthracite	20W	1400	19,5W	2120	100°	3000K	250VDC/ 64mA	2,00

INSTALLAZIONE APPLICATION



Terra/Floor

DISEGNI TECNICI TECHNICAL DRAWINGS

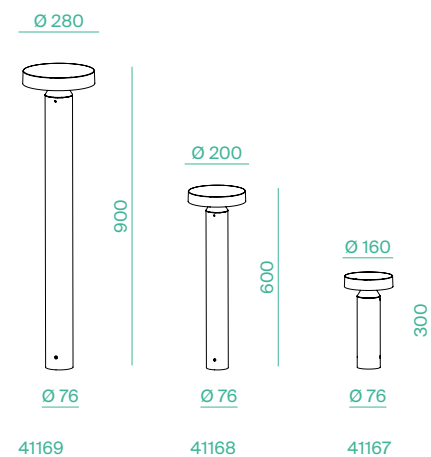

MOONLIGHT PARETE



LED RF2835
CRI 80
PF 0.9

CODE	FINISHING	WATT	LUMEN	WATT LIGHT SOURCE	LUMEN LIGHT SOURCE	BEAM	KELVIN	DRIVER	KG
41166	Antracite/ Anthracite	15W	1050	14,5W	1650	90°	3000K	250VDC/48mA	0,90

INSTALLAZIONE APPLICATION



Parete/Wall

DISEGNI TECNICI TECHNICAL DRAWINGS

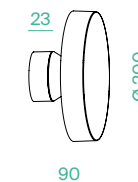

ACCESSORI ACCESSORIES



CODE	FINISHING	DESCRIPTION
11554	Antracite/ Anthracite	Distanziale per parete / Wall mounting spacer



Fos



Apparecchio a parete e terra LED integrato orientabile in alluminio estruso
Driver integrato

*Built-in LED wall-bracket and floor adjustable in extruded aluminium
Built-in driver*

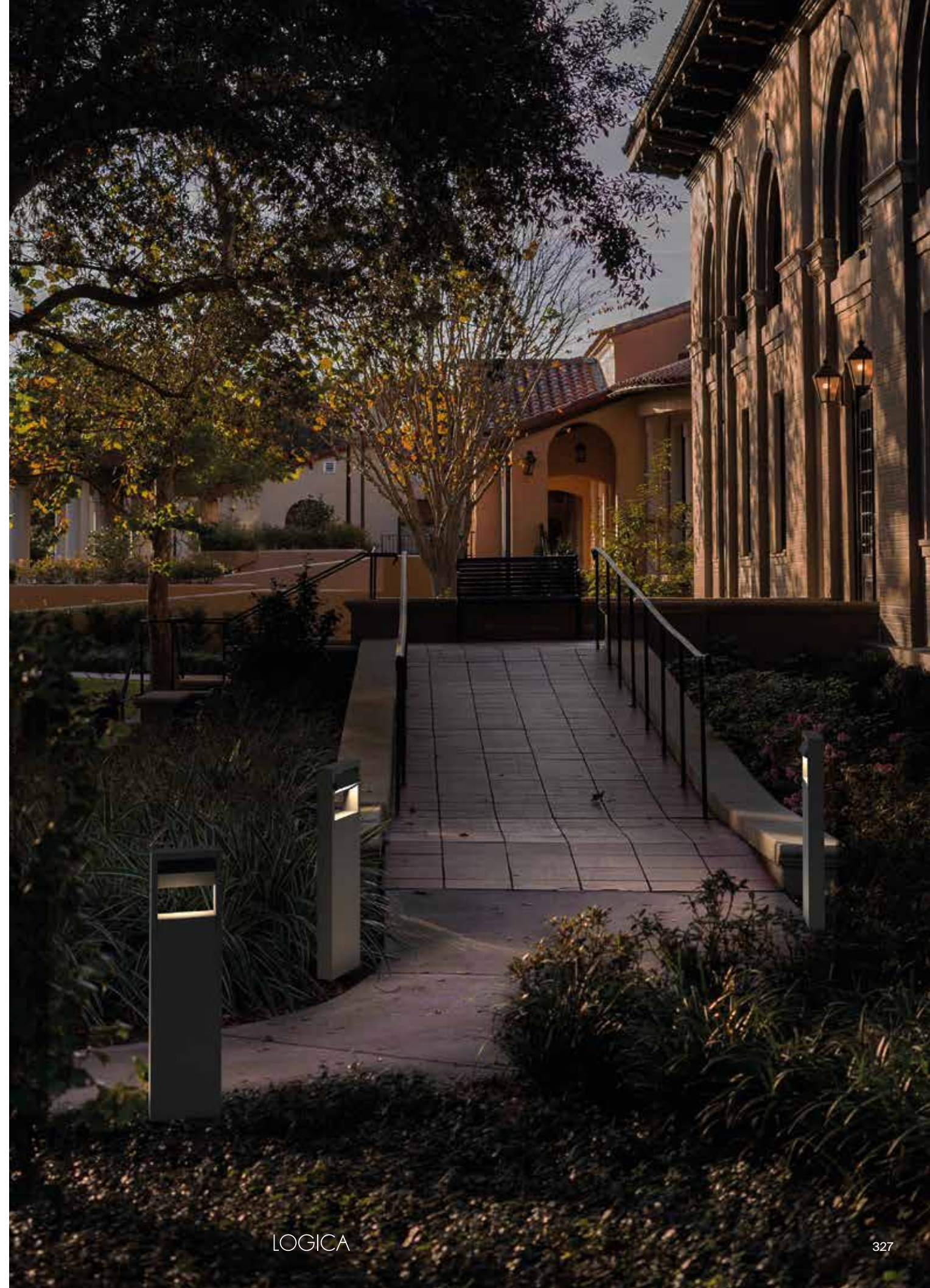

FOS PALO



LED RF2835
CRI 80
PF 0.9

CODE	FINISHING	WATT	LUMEN	WATT LIGHT SOURCE	LUMEN LIGHT SOURCE	BEAM	KELVIN	DRIVER	KG
41165	Antracite/ Anthracite	8W	650	6,4W	860	120°	3000K	250VDC/48mA	1,70

INSTALLAZIONE APPLICATION



Terra/Floor

DISEGNI TECNICI TECHNICAL DRAWINGS

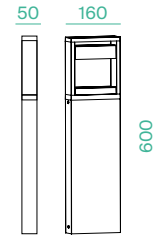

REGOLAZIONI ADJUSTABILITY



FOS PARETE



LED RF2835
CRI 80
PF 0.9

CODE	FINISHING	WATT	LUMEN	WATT LIGHT SOURCE	LUMEN LIGHT SOURCE	BEAM	KELVIN	DRIVER	KG
41164	Antracite/ Anthracite	8W	650	6,4W	860	120°	3000K	250VDC/48mA	1,10

INSTALLAZIONE APPLICATION



Parete/Wall

DISEGNI TECNICI TECHNICAL DRAWINGS

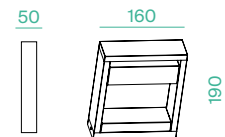

REGOLAZIONI ADJUSTABILITY

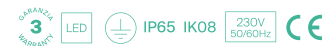

Combi_Evo

COMBI_EVO



LED BRIDGELUX
CRI >80
PF >0.5

CODE	FINISHING	WATT	LUMEN	WATT LIGHT SOURCE	LUMEN LIGHT SOURCE	BEAM	KELVIN	DRIVER	KG
43168	Bianco/White	5W+5W	445+445	4,5W+4,5W	563+563	0-90°	3000K	300mA 100-240V	0,64
43169	Nero/Black	5W+5W	445+445	4,5W+4,5W	563+563	0-90°	3000K	300mA 100-240V	0,64

INSTALLAZIONE APPLICATION



Parete/Wall

DISEGNI TECNICI TECHNICAL DRAWINGS

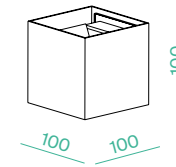

REGOLAZIONI ADJUSTABILITY



Apparecchio a parete bi-emissione
Corpo in alluminio pressofuso
Ottica regolabile
Driver integrato

*Built-in LED wall-bracket Double-sided emission
Die-cast aluminium body A
adjustable beam
Built-in driver*



LOGICA

Dardo



Proiettore LED integrato orientabile
Corpo in alluminio pressofuso verniciato
Driver integrato
Dispositivo anticondensa

*Adjustable built-in LED projector
Painted die-cast aluminium body
Built-in driver
Equipped with anti-condensation device*

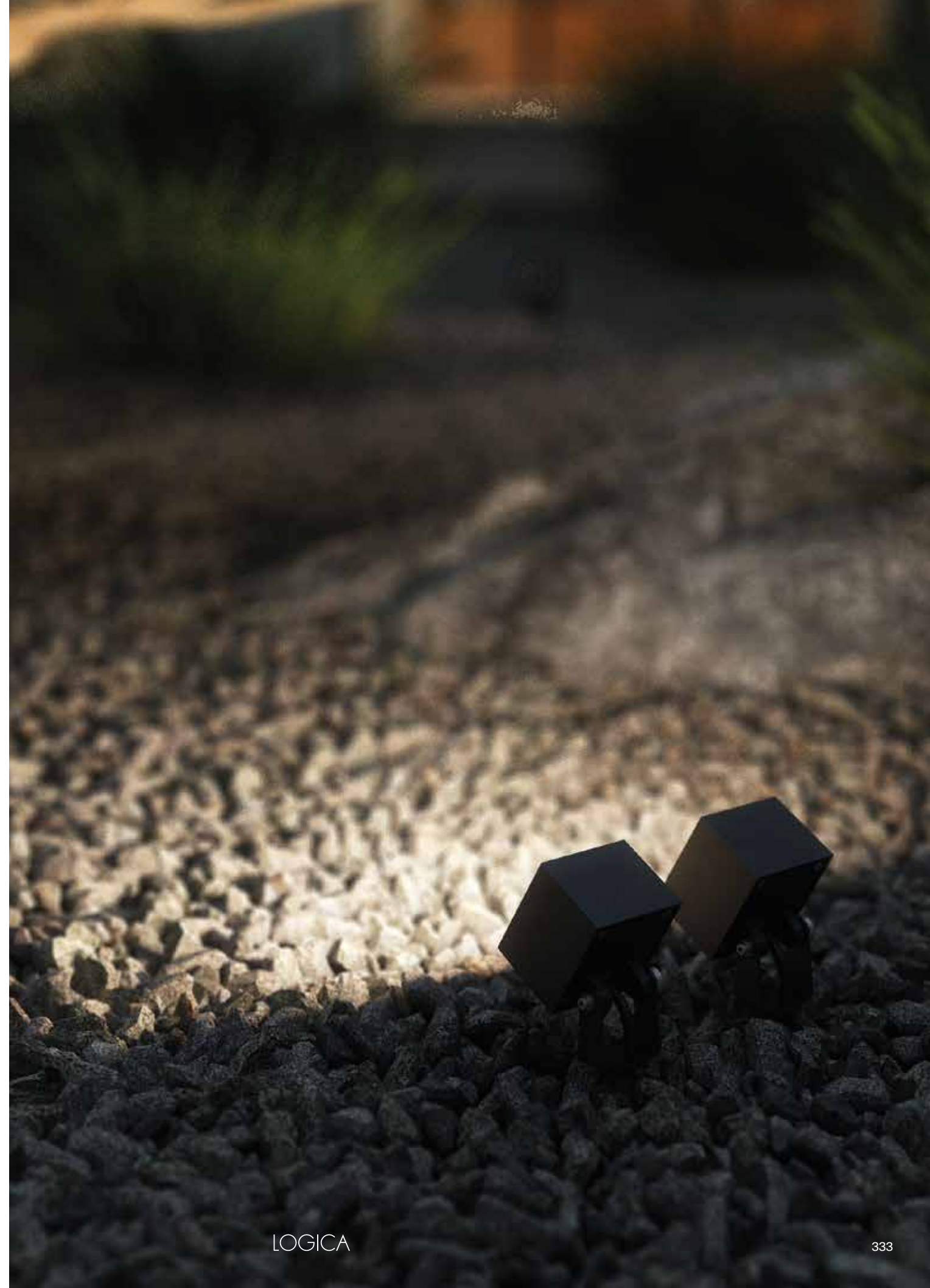

DARDO



CODE	FINISHING	WATT	LUMEN	WATT LIGHT SOURCE	LUMEN LIGHT SOURCE	BEAM	KELVIN	KG
42790	Antracite/ Anthracite	6W	320	4,2W	397	30°	3000K	1,20

INSTALLAZIONE APPLICATION



Terra/Floor



Parete/Wall

DISEGNI TECNICI TECHNICAL DRAWINGS

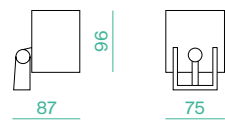

REGOLAZIONI ADJUSTABILITY



ACCESSORI ACCESSORIES

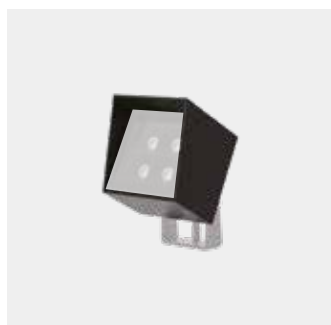

42791



42792

CODE	DESCRIPTION
42791	Accessorio anti-glare/Anti-glare accessory
42792	Accessorio picchetto in plastica/Plastic spike accessory

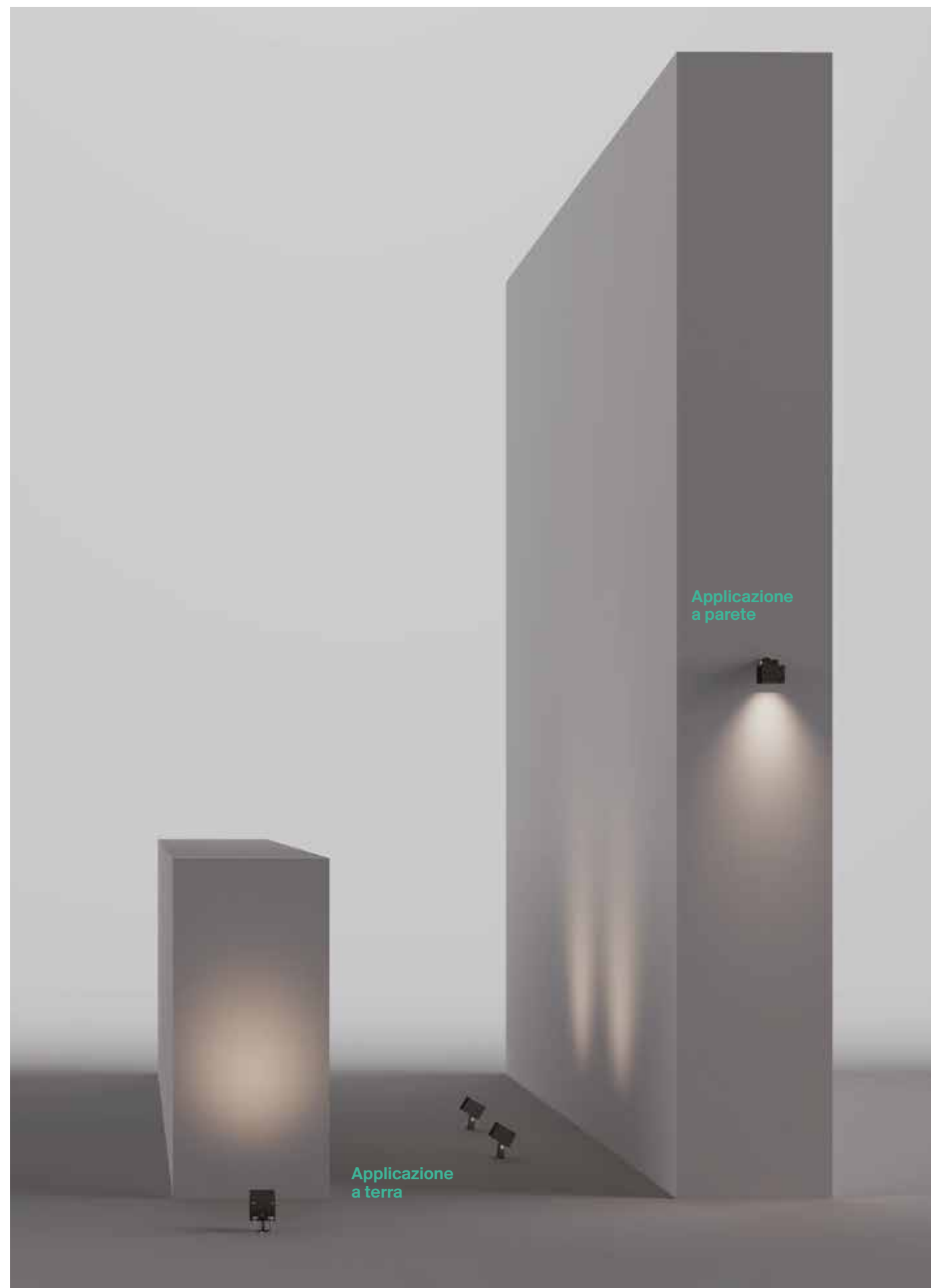

Skorpio



Incasso calpestabile LED integrato Corpo in alluminio anodizzato
Anello inox AISI 316
Vetro temperato trasparente Cassaforma in PVC
Driver integrato

*Walk-over recessed fitting with built-in LED Anodized aluminium body
AISI 316 stainless steel ring
Transparent tempered glass
PVC frame-work Built-in driver*



SKORPIO S



LED COB EDISON
CRI >80
PF 0.5

CODE	FINISHING	WATT	LUMEN	WATT LIGHT SOURCE	LUMEN LIGHT SOURCE	BEAM	KELVIN	KG
40248	Inox	4,5W	265	3,2W	332	35°	3000K	0,70
40249	Inox	4,5W	275	3,1W	359	35°	5000K	0,70

INSTALLAZIONE APPLICATION



Calpestabile/
Walk-Over

DISEGNI TECNICI TECHNICAL DRAWINGS

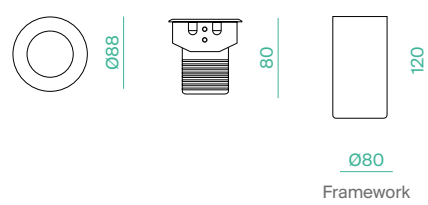

SKORPIO L

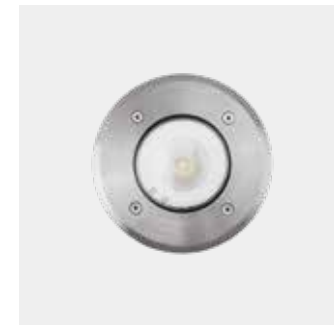

LED COB EDISON
CRI >80
PF 0.5

CODE	FINISHING	WATT	LUMEN	WATT LIGHT SOURCE	LUMEN LIGHT SOURCE	BEAM	KELVIN	KG
40250	Inox	10W	600	9W	806	35°	3000K	1,42
40251	Inox	10W	615	9,1W	824	35°	5000K	1,42

INSTALLAZIONE APPLICATION



Calpestabile/
Walk-Over

DISEGNI TECNICI TECHNICAL DRAWINGS

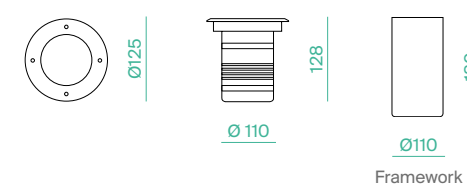

SKORPIO ACCESSORI ACCESSORIES



40015

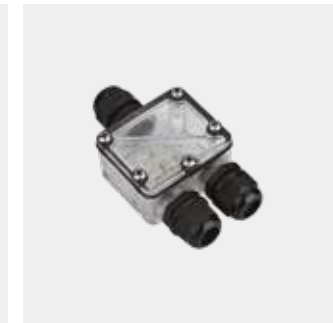

40016

CODE	DESCRIPTION
40015	Connettore IP67 1 via / IP67 connector_one exit
40016	Connettore IP67 2 vie / IP67 connector_two exits



**DRIVER
E ACCESSORI**

**GRUPPO
EMERGENZA
EMERGENCY
UNIT**

CODE	EFFICIENCY	WATT	KG
12551	30% - 90MIN.	MAX 40W	0,10

**DISEGNI TECNICI
TECHNICAL DRAWINGS**

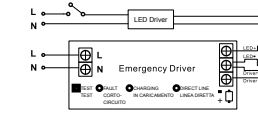
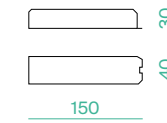

DRIVER



CODE	VOLTAGE	CURRENT	MODEL	SIZE	MODE
42683	220-240 12-42V	650-1100mA	ONE4ALL	125x76x30mm	DALI, PUSH, 1-10V
42684	220-240 12-42V	250-600mA	ONE4ALL	125x76x30mm	DALI, PUSH, 1-10V
40314	110-277V 14-42V	400-1100mA	n/a	115x52x30mm	1-10V

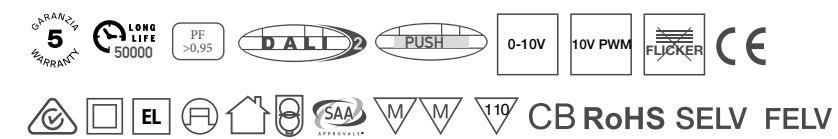

Lista di dimmer compatibili

Dimmer compatibility list

DICRO_PRECISE
35
MODULE_PRECISE
35



- Dimmer ottimo /Good dimming
- Dimmer accettabile /Accetable dimming
- Dimmer malfunzionante/ Undesirable dimming
- T Taglio di fase discendente /Trailing Edge
- L Taglio di fase ascendente /Leading Edge
- U Universale/Universal

NO.	MANUFACTURER	MODELS	TYPE	MR11 3,5W		MODULE_PRECISE 5,5W	
				1 Lamp	5 Lamps	1 Lamp	5 Lamps
1	ALED	EasyDimmer 200	T	●	●	●	●
2	ALED	EasyDimmer 500	U	●	●	●	●
3	ABB	STD 50-3	L	●	●	●	●
4	Bticino	AM5706	L	●	Min 2pcs	●	Min 2pcs
5	Busch-Jaeger	6513 U-102	T	●	●	●	●
6	Busch-Jaeger	6523 U-102	T	●	●	●	●
7	Busch-Jaeger	6517U-101	L	●	●	●	●
8	BG	DM400AP	L	●	●	●	●
9	Click	MD9022	L	●	●	●	●
10	Danlers	DQDGD MK400W	T	●	●	●	●
11	DIMINTELL	DIMMAX 520 S	U	●	●	●	●
12	DINUY	RE EL1 LE1	U	●	●	●	●
13	Ecopac	EcoDim Triac	L	●	Min 2pcs	●	Min 2pcs
14	Eltako	EUD61NPN230V	U	●	●	●	●
15	ELKO	315GLE	T	●	●	●	●
16	ELKO	316GLED	T	●	●	●	●
17	ELKO	420GLE/I	T	●	●	●	●
18	ETMAN	ETM31PV2	U	●	●	●	●
19	ETMAN	ETM329P	U	●	●	●	●
20	Eltako	EUD61NPN230V	U	●	●	●	●
21	EverFlourish	DFM700DB	L	●	●	●	●
22	EHMANN	T55.20	T	●	●	●	●
23	Feller	40600 RLC	L	●	●	●	●
24	Hamilton	LITESTAT 40-400W	L	●	●	●	●
25	Hamilton	LEDITB 5-100W	T	●	●	●	●
26	GEWISS	GW 20 815	L	●	●	●	●
27	Jung	244 HEX	L	●	●	●	●
28	Jung	225 NVDE	L	●	●	●	●
29	Kopp	8085	L	●	Min 2pcs	●	Min 2pcs
30	Kopp	8033	L	●	●	●	●
31	Kightbridge	CU2161	L	●	●	●	●
32	Kightbridge	VFR200M	T	●	●	●	●
33	LK	FUGA 506DA219	T	●	●	●	●
34	LK	FUGA 506DA127	T	●	●	●	●
35	LK	IHC LED DIMMER 820B1250	T	●	●	●	●
36	Merten	MEG 5133	L	●	●	●	●
37	PEHA	435 HAN	L	●	●	●	●
38	NIKO	310-01900/01901	U	●	●	●	●

39	REV	ETI 66021B	T	●	●	●	●
40	Robus	RLA200DT01	T	●	●	●	●
41	Robus	RLA250DTG-01 Loadpro 250W	T	●	●	●	●
42	RELCO	NISKO NS1-40611	L	●	●	●	●
43	SAL	SDA450	T	●	●	●	●
44	SAL	SDD400U	U	●	●	●	●
45	SAL	SDD350T	T	●	●	●	●
46	SAL	SDD350UM	U	●	●	●	●
47	SAL	SDD350TCM	T	●	●	●	●
48	SG	LEDDIM 200	T	●	●	●	●
49	SG	LEDDIM SMART PUSH	T	●	●	●	●
50	Schneider	WDE002299		●	●	●	●
51	Shuttle	SDIMTLED125W	T	●	●	●	●
52	Spazio	SPL TRIDIM 842	T	●	●	●	●
53	Spazio	SPL UNIDIM 201	T	●	●	●	●
54	Unitec	30815	U	●	●	●	●
55	VADSBO	LD 220	T	●	●	●	●
56	Vimar	20135	U	●	●	●	●
57	Varilight	HQ1W	L	●	Min 2pcs	●	Min 2pcs
58	Varilight	HQ3W	L	●	Min 2pcs	●	Min 2pcs
59	VADSBO	VD200	T	●	●	●	●
60	Yokis	MTV500E	U	●	●	●	●
61	ZANO	ZMO150	T	●	●	●	●
62	Finder	15.10.8		●	●	●	●
63	ZANO	ZMO250	T	●	●	●	●

MODULE_PRECISE
50
DIMMER
COMPATIBILITY



- Dimmer ottimo /Good dimming
- Dimmer accettabile /Accetable dimming
- Dimmer malfunzionante/ Undesirable dimming
- T Taglio di fase discendente /Trailing Edge
- L Taglio di fase ascendente /Leading Edge
- U Universale/Universal

NO.	MANUFACTURER	MODELS	TYPE	MODULE_PRECISE 50MM		NO.	MANUFACTURER	MODELS	TYPE	MODULE_PRECISE 50MM	
				1 Lamp	5 Lamps					1 Lamp	5 Lamps
1	ALED	EasyDimmer 200	T	●	●	18	ETMAN	ETM31PV2	U	●	●
2	ALED	EasyDimmer 500	U	●	●	19	ETMAN	ETM329P	U	●	●
3	ABB	STD 50-3	L	●	●	20	Eltako	EUD61NPN230V	U	●	●
4	Bticino	AM5706	L	●	Min 2pcs	21	EverFlourish	DFM700DB	L	●	●
5	Busch-Jaeger	6513 U-102	T	●	●	22	EHMANN	T55.20	T	●	●
6	Busch-Jaeger	6523 U-102	T	●	●	23	Feller	40600 RLC	L	●	●
7	Busch-Jaeger	6517U-101	L	●	●	24	Hamilton	LITESTAT 40-400W	L	●	●
8	BG	DM400AP	L	●	●	25	Hamilton	LEDITB 5-100W	T	●	●
9	Click	MD9022	L	●	●	26	GEWISS	GW 20 815	L	●	Min 2pcs
10	Danlers	DQDGD MK400W	T	●	●	27	Jung	244 HEX	L	●	●
11	DIMINTELL	DIMMAX 520 S	U	●	●	28	Jung	225 NVDE	L	●	●
12	DINUY	RE EL1 LE1	U	●	●	29	Kopp	8085	L	●	●
13	Ecopac	EcoDim Triac	L	●	Min 2pcs	30	Kopp	8033	L	●	●
14	Eltako	EUD61NPN230V	U	●	●	31	Kightbridge	CU2161	L	●	●
15	ELKO	315GLE	T	●	●	32	Kightbridge	VFR200M	T	●	●
16	ELKO	316GLED	T	●	●	33	LK	FUGA 506DA219	T	●	●
17	ELKO	420GLE/I	T	●	●	34	LK	FUGA 506DA127	T	●	●

NO.	MANUFACTURER	MODELS	TYPE	MODULE_PRECISE50MM	
				1 Lamp	5 Lamps
35	LK	IHC LED DIMMER 820B1250	T	●	●
36	Merten	MEG 5133	L	●	●
37	PEHA	435 HAN	L	●	●
38	NIKO	310-01900/01901	U	●	●
39	REV	ET1 66021B	T	●	●
40	Robus	RLA200DT01	T	●	●
41	Robus	RLA250DTG-01 Loadpro 250W	T	●	●
42	RELCO	NISKO NS1-40611	L	●	●
43	SAL	SDA450	T	●	●
44	SAL	SDD400U	U	●	●
45	SAL	SDD350T	T	●	●
46	SAL	SDD350UM	U	●	●
47	SAL	SDD350TCM	T	●	●
48	SG	LEDDIM 200	T	●	●

NO.	MANUFACTURER	MODELS	TYPE	MODULE_PRECISE50MM	
				1 Lamp	5 Lamps
49	SG	LEDDIM SMART PUSH	T	●	●
50	Schneider	WDE002299		●	●
51	Shuttle	SDIMTLED125W	T	●	●
52	Spazio	SPL TRIDIM 842	T	●	●
53	Spazio	SPL UNIDIM 201	T	●	●
54	Unitec	30815	U	●	●
55	VADSBO	LD 220	T	●	●
56	Vimar	20135	U	●	●
57	Varilight	HQ1W	L	●	Min 2pcs
58	Varilight	HQ3W	L	●	●
59	VADSBO	VD200	T	●	●
60	Yokis	MTV500E	U	●	●
61	ZANO	ZMO150	T	●	●
62	Finder	15.10.8		●	●
63	ZANO	ZMO250	T	●	●

NO.	MANUFACTURER	MODELS	TYPE	PRO+EVO	
				1 Lamp	5 Lamps
46	EverFlourish	DFM700DB	L	●	●
47	Feller	40200 R.L.C	U	●	●
48	Feller	40300 R.C	T	●	●
49	Feller	40420 R.L.C	U	●	●
50	Finder	15.21.8.230.0200	U	●	●
51	GEWISS	GW 20 803	L	●	Min 2pcs
52	GEWISS	GW 20 815	L	●	Min 2pcs
53	Gira	30700	T	●	●
54	Gira	System 2000	L	●	●
55	Gira	1176-00/01	U	●	●
56	Hager	EVN 011	T	●	●
57	Hager	EVN 012	T	●	●
58	Hamilton	KP1X40	L	●	●
59	Hamilton	HGDM250W	T	●	●
61	Hamilton	LEDITB100	T	●	●
62	Hamilton	LITESTAT	L	●	●
63	Hilux	To-Dim-LED 500	U	●	●
64	ILUMINIZE	511,201	T	●	●
65	Jung	225 TDE	T	●	●
66	Jung	1730DD	T	●	●
67	Jung	266 GDE	L	●	●
68	Jung	254 UDIE I	U	●	●
69	Jung	243EX	T	●	●
70	Jung	244 HEX	L	●	●
71	Kopp	8002	T	●	●
72	Kopp	8085	L	●	●
73	Kopp	8033	L	●	●
74	Knightbridge	CS2181AB	T	●	●
75	Knightbridge	VFR200M	T	●	●
76	Knightbridge	CU2161	L	●	●
77	Legrand	78405	L	●	●
78	Legrand	Niloe 665117	T	●	Min 2pcs
79	Legrand	281080	T	●	●
80	Legrand	Cat 400T	T	●	●
81	Legrand	67082	L	●	●
82	Legrand	67085	T	●	Min 2pcs
83	LK	506DA219	T	●	●
84	LK	FUGA 506DA127	T	●	●
85	LK	820B1250	T	●	●
86	LUMEX	LT1D450LS GeN2	T	●	●
87	Lutron	QSNE-4A5-230-D	T	●	●
88	Lutron	Vive RMKS-250NE	T	●	●
89	Lutron	"LQSE-4A-D (Gen.2)/ QSNE-4A-D (Gen. 2)"	T	●	●
90	Lutron	RRK-R25NE-24	T	●	●
91	Lutron	LQSE-4A5-230-D	T	●	●
92	Lutron	HQRx-P20-240y	T	●	●
93	Lutron	RRx-P20-240y	T	●	●
94	MK	K4501	T	●	●
95	MK	K1501LV	L	●	●
96	MK	K1523 WHILV	T	●	●
97	MK	GX8501 WHI	L	●	Min 2pcs
98	MAXCOMFORT	ADAM2	T	●	●
99	MEGAMAN	SSLDI50	T	●	●
100	Meister	EF700DC	L	●	Min 2pcs
101	NIKO	31001900	U	●	●
102	NIKO	310-0280X	T	●	●
103	Panasonic	WEJ57515	L	●	Min 2pcs
104	Philips	UID8470/10	T	●	●
105	RAKO	RMT500	U	●	●

NO.	MANUFACTURER	MODELS	TYPE	PRO+EVO	
				1 Lamp	5 Lamps
106	RAKO	RAK4T	U	●	●
107	Relco	RL1724	L	●	●
108	Relco	RT65ROA	L	●	●
109	RELCO	NISKO NS1-40611	L	●	●
110	Rev	PrimaLuxe 0511442992	L	●	Min 2pcs
111	Rev	DWS700DB	L	●	Min 2pcs
112	Rev	ET1 66012B	T	●	●
113	Robus	RLA200DT01	T	●	●
114	Robus	RLA250DTG-01 Loadpro 250W	T	●	●
115	Shuttle	SDIMTLED125W	T	●	●
116	Spazio	SPL TRIDIM 842	T	●	●
117	Spazio	SPL UNIDIM 201	T	●	●
118	Schneider	ALB45192	L	●	Min 2pcs
119	Schneider	SBD200LED	T	●	●
120	Schneider	SBD315RC	T	●	●
121	Schneider	MTN577199	T	●	●
122	Schneider	MTN51350000	L	●	●
123	Schneider	CCT5010-0002W	U	●	●
124	Schneider	WDE002311	T	●	●
125	Schneider	WDE002299	T	●	●
126	Schneider	WDE002319	T	●	●
127	Schneider	E3031HD	T	●	●
128	Schneider	Rocca	L	●	●
129	Schneider	E8331RD250_WE_C1	L	●	●
130	SAL	SDA450	T	●	●
131	SAL	SDD400U	U	●	●
132	SAL	SDD350T	T	●	●
133	SAL	SDD350UM	U	●	●
134	SAL	SDD350TCM	T	●	●
135	SG	LEDDIM 200	T	●	●
136	SG	LEDDIM SMART PUSH	T	●	●
137	Star Trading	39901	L	●	●
138	theben	DIMAX 542 plus S	U	●	●
139	Tradim	2485H	T	●	●
140	Tradium	2490HP-exop	T	●	●
141	Tradium	2494-K-exop	T	●	●
142	Unitec	42074L	L	●	●
143	Unitec	STDSIU1104	L	●	Min 2pcs
144	Unitec	30815	U	●	●
145	VADSBO	LD 220	T	●	●
146	VADSBO	VD220	T	●	●
147	VARILIGHT	HQ1W	L	●	Min 2pcs
148	VARILIGHT	HQ3W	L	●	Min 2pcs
149	VARILIGHT	JQP401W	T	●	●
150	VARILIGHT	VPro Z11400M	T	●	●
151	VERMER	VE773400	U	●	●
152	Vimar	20148	L	●	●
153	Vimar	20160	T	●	●
154	WUYUNELEK	W13C192	T	●	●
155	Yokis	MTV500E	U	●	●
156	Zano	ZGRID500	T	●	●
157	Zano	ZMO150	T	●	●
158	Zano	ZMO250	T	●	●

PRO+EVO
REAL COLOUR
PRO+EVO
HIGH_OUTPUT

DIMMER
COMPATIBILITY



- Dimmer ottimo /Good dimming
- Dimmer accettabile /Accettable dimming
- Dimmer malfunzionante/ Undesirable dimming
- T Taglio di fase discendente /Trailing Edge
- L Taglio di fase ascendente /Leading Edge
- U Universale/Universal

NO.	MANUFACTURER	MODELS	TYPE	PRO+EVO	
				1 Lamp	5 Lamps
1	ALED	EasyDimmer 200	T	●	●
2	ALED	EasyDimmer 500	U	●	●
3	ABB	STD 50-3	L	●	●
4	ABB	AE412	T	●	●
5	Aurora	AUDSP 400	L	●	●
6	Aurora	AUDSP 400X	L	●	●
7	Atom	AT9300A	T	●	●
8	Berker	2873	L	●	●
9	Berker	2867 10	L	●	Min 2pcs
10	Berker	2830 10	L	●	●
11	Bticino	MATIX AM5702	L	●	●
12	Bticino	MATIX AM5706	L	●	●
13	British General	VKDM400E	L	●	●
14	British General	DM400AP	L	●	Min 2pcs
15	Busch-Jaeger	6513 U-102	T	●	●
16	Busch-Jaeger	6517U-101	L	●	●
17	Busch Jaegar	6523 U102	T	●	●
18	Busch Jaegar	2247U	L	●	●
19	Busch Jaegar	2250U	L	●	●
20	Casambi	CBU-TED	T	●	●
21	Click	MD9022	L	●	Min 2pcs
22	Clipsal	32E450UD	U	●	●

NO.	MANUFACTURER	MODELS	TYPE	PRO+EVO	
				1 Lamp	5 Lamps
23	Clipsal	32E450LM	L	●	●
24	Clipsal	32E450TM	T	●	●
25	Clipsal	CLDM350TS	T	●	●
26	Clipsal	31E2RUDM	U	●	●
27	Clipsal	32ELEDM	T	●	●
28	Danlers	MOD400	L	●	●
29	Danlers	DQD6DMK-400W	T	●	●
30	DIMEZE	DZ2G450DIAL	T	●	●
31	DIMINTELL	DIMMAX 520 S	U	●	●
32	Dynalite	DDTM102 Module	T	●	●
33	DINUY	RE EL1 LE1	U	●	●
34	DIMINTELL	DIMMAX 520 S	U	●	●
35	Ecopac	EcoDim-Triac	L	●	●
36	ELKO	316 GLED	U	●	●
37	ELKO	RS16 315 GLE	T	●	●
38	ELKO	CCTEL12013	T	●	●
39	ELKO	630GLE	T	●	●
40	ELKO	EKO07090	T	●	●
41	Eitako	EUD61NPN230V	U	●	●
42	Eitako	EUD61NPN-UC	U	●	●
43	ETMAN	ETM31PV2	U	●	●
44	ETMAN	ETM329P	U	●	●
45	EHMANN	T55.20	T	●	●

DICRO_50_DTW (DIM TO WARM)

DIMMER COMPATIBILITY



- Dimmer ottimo /Good dimming
- Dimmer accettabile /Accettable dimming
- Dimmer malfunzionante/ Undesirable dimming
- T Taglio di fase discendente /Trailing Edge
- L Taglio di fase ascendente /Leading Edge
- U Universale/Universal

NO.	MANUFACTURER	MODELS	TYPE	DTW GU10	
				1 Lamp	5 Lamps
1	ALED	EasyDimmer 200	T	●	●
2	ALED	EasyDimmer 500	U	●	●
3	ABB	STD 50-3	L	●	●
4	ABB	AE412	T	●	●
5	Aurora	AUDSP 400	L	●	●
6	Aurora	AUDSP 400X	L	●	●
7	Atom	AT9300A	T	●	●
8	Berker	2873	L	●	●
9	Berker	2867 10	L	●	●
10	Berker	2830 10	L	●	●
11	Bticino	MATIX AM5702	L	●	●
12	Bticino	MATIX AM5706	L	●	●
13	British General	VKDM400E	L	●	●
14	British General	DM400AP	L	●	●
15	Busch-Jaeger	6513 U-102	T	●	●
16	Busch-Jaeger	6517U-101	L	●	●
17	Busch Jaegar	6523 U102	T	●	●
18	Busch Jaegar	2250U	L	●	●
19	Casambi	CBU-TED	T	●	●
20	Click	CMA145 MD9022	L	●	●
21	Clipsal	32E450UD	U	●	●
22	Clipsal	32E450LM	L	●	●
23	Clipsal	32E450TM	T	●	●
24	Clipsal	CLDM350TS	T	●	●
25	Clipsal	31E2RUUDM	U	●	●
26	Clipsal	32ELEDM	T	●	●
27	Finder	15.10.8		●	●
28	Danlers	MOD400	L	●	●
29	Danlers	DQD6DMK-400W	L	●	●
30	DIMINTELL	DIMMAX 520 S	U	●	●
31	Dynalite	DDTM102 Module	T	●	●
32	DINUY	RE EL1 LE1	U	●	●
33	DIMINTELL	DIMMAX 520 S	U	●	●
34	Ecopac	EcoDim-Triac	T	●	●
35	ELKO	RS16/400	L	●	●
36	ELKO	CCTEL12013	T	●	●
37	ELKO	630GLE	T	●	●
38	ELKO	EKO07090	T	●	●
39	Eitako	EUD61NPN230V	U	●	●
40	Eitako	EUD61NPN-UC	U	●	●
41	ETMAN	ETM31PV2	U	●	●
42	ETMAN	ETM329P	U	●	●
43	EHMANN	T55.20	T	●	●
44	EverFlourish	DFM700DB	L	●	●
45	GEWISS	GW 20 803	L	●	●
46	GEWISS	GW 20 815	L	●	●
47	Gira	30700	T	●	●
48	Gira	System 2000	L	●	●
49	Hamilton	KPQX40	L	●	●

NO.	MANUFACTURER	MODELS	TYPE	DTW GU10	
				1 Lamp	5 Lamps
50	Hamilton	HGDM250W VA	T	●	●
52	Hamilton	DQD6DMK-400W	L	●	●
53	Hamilton	741 XLEDITB100	T	●	●
54	Hilux	To-Dim-LED 500	U	●	●
55	ILUMINIZE	511,201	T	●	●
56	Jung	225 TDE	T	●	●
57	Jung	1730DD	T	●	●
58	Jung	266 GDE	L	●	●
59	Jung	254 UDIE I	U	●	●
60	JUNG	243EX	T	●	●
61	Jung	244 HEX	L	●	●
62	Kopp	8002	T	●	●
63	Kopp	8085	L	●	●
64	Kopp	8033	L	●	●
65	Knightbridge	CS2181AB	L	●	●
66	Knightbridge	VFR200M	T	●	●
67	Knightbridge	CU2161	L	●	●
68	Legrand	78405	L	●	●
69	Legrand	Niloe 665117	T	●	●
70	Legrand	281080	T	●	●
71	Legrand	Cat 400T	T	●	●
72	Legrand	67082	L	●	●
73	Legrand	67085	T	●	●
74	LK	506DA219	T	●	●
75	LK	FUGA 506DA127	T	●	●
76	LK	820B1250	T	●	●
77	LUMEX	LT1D450LS GeN2	T	●	●
78	Lutron	QSNE-4A5-230-D	T	●	●
79	Lutron	Vive RMKS-250NE	T	●	●
80	Lutron	"LQSE-4A-D (Gen.2)/ QSNE-4A-D (Gen. 2)"	T	●	●
81	Lutron	RRK-R25NE-24	T	●	●
82	Lutron	LQSE-4A5-230-D	T	●	●
83	Lutron	HQRx-P20-240y	T	●	●
84	Lutron	RRx-P20-240y	T	●	●
85	MK	K4501	T	●	●
86	MK	K1501LV	L	●	●
87	MK	K1523 WHILV	T	●	●
88	MK	GX8501 WHI	L	●	Min 2pcs
89	MAXCOMFORT	ADAM2	T	●	●
90	Meister	EF700DC	L	●	Min 2pcs
91	NIKO	31001900	U	●	●
92	NIKO	310-0280X	T	●	●
93	Panasonic	WEJ57515	L	●	●
94	RAKO	RMT500	U	●	●
95	RAKO	RAK4T	U	●	●
96	Relco	RL1724	L	●	●
97	Relco	RT65ROA	L	●	●

NO.	MANUFACTURER	MODELS	TYPE	DTW GU10	
				1 Lamp	5 Lamps
98	RELCO	NISKO NS1-40611	L	●	●
99	Rev	PrimaLuxe 0511442992	L	●	●
100	Rev	DWS700DB	L	●	●
101	Rev	ET1 66012B	T	●	●
102	Robus	RLA200DT01	T	●	●
103	Robus	RLA250DTG-01 Loadpro 250W	T	●	●
104	Shuttle	SDIMTLED125W	T	●	●
105	Spazio	SPL TRIDIM 842	T	●	●
106	Spazio	SPL UNIDIM 201	T	●	●
107	Schneider	ALB45192	L	●	●
108	Schneider	SBD200LED	T	●	●
109	Schneider	MTN577199	T	●	●
110	Schneider	MTN51350000	L	●	●
111	Schneider	CCT011533	T	●	●
112	Schneider	WDE002311	T	●	●
113	Schneider	WDE002299	T	●	●
114	Schneider	WDE002319	T	●	●
115	Schneider	E3031HD	T	●	●
116	Schneider	Rocca	L	●	●
117	Schneider	E8331RD250_WE_C1	L	●	●
118	SAL	SDA450	T	●	●
119	SAL	SDD400U	U	●	●
120	SAL	SDD350T	T	●	●
121	SAL	SDD350UM	U	●	●

NO.	MANUFACTURER	MODELS	TYPE	DTW GU10	
				1 Lamp	5 Lamps
122	SAL	SDD350TCM	T	●	●
123	SG	LEDDIM 200	T	●	●
124	SG	LEDDIM SMART PUSH	T	●	●
125	Star Trading	39901	L	●	●
126	theben	DIMAX 542 plus S	U	●	●
127	Tradim	2485H	T	●	●
128	Tradium	2490HP-exop	T	●	●
129	Tradium	2494-K-exop	T	●	●
130	Unitec	42074L	L	●	●
131	Unitec	STDSIU1104	L	●	●
132	Unitec	30815	U	●	●
133	VADSBO	LD 220	T	●	●
134	VADSBO	VD220	T	●	●
135	VARILIGHT	HQ3W	L	●	●
136	VARILIGHT	JQP401W	T	●	●
137	VARILIGHT	VPro Z11400M	T	●	●
138	VERMER	VE773400	U	●	●
139	Vimar	20148	T	●	●
140	WUYUNELEK	W13C192	T	●	●
141	DIMEZE	DZ2G450DIAL	L	●	●
142	MEGAMAN	SSLD150	T	●	●
143	Yokis	MTV500E	U	●	●
144	Zano	ZGRID500	T	●	●
145	Zano	ZMO150	T	●	●
146	Zano	ZMO250	T	●	●

QR14 LED REAL_COLOUR +HIGH_OUTPUT

DIMMER COMPATIBILITY

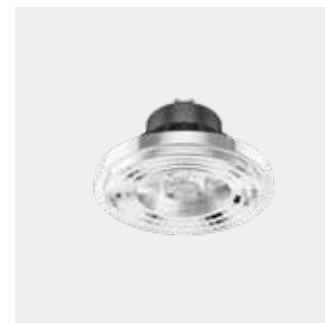

- Dimmer ottimo /Good dimming
- Dimmer accettabile /Accettable dimming
- Dimmer malfunzionante/ Undesirable dimming
- T Taglio di fase discendente /Trailing Edge
- L Taglio di fase ascendente /Leading Edge
- U Universale/Universal

NO.	MANUFACTURER	MODELS	MAX LOAD	TYPE	QR14	
					1 Lamp	5 Lamps
1	ALED	EasyDimmer 200	200VA	T	●	●
2	ALED	EasyDimmer 500	500VA	U	●	●
3	ABB	AL412-G	400W	L	●	Min 2 pcs
4	ABB	STD-500U(6583-500)	450VA	U	●	●
5	Aurora	AUDSP 400	60-400W	L	●	●
6	Aurora	AUDSP 400X	60-400VA	L	●	●
7	Atom	AT9300A	200VA	T	●	●
8	Berker	2867 10	20-260W	L	●	●
9	Berker	2830 10	60-400W	L	●	●
10	Bticino	MATIX AM5702	60-500W	L	●	●
11	Bticino	MATIX AM5706	500W	L	●	●
12	Bticino	L4402N	500W	L	●	Min 2 pcs
13	British General	DM400AP	60-400W	L	●	●
14	Busch-Jaeger	6513 U-102	40-420W	T	●	●
15	Busch-Jaeger	6517U-101	60-400VA	L	●	●

NO.	MANUFACTURER	MODELS	MAX LOAD	TYPE	QR14	
					1 Lamp	5 Lamps
16	Busch Jaegar	6523 U102	2-100VA	T	●	●
17	Busch Jaegar	2247U	20-500W	L	●	●
18	Busch Jaegar	2250U	60-600W	L	●	●
19	Casambi	CBU-TED	150VA	T	●	●
20	Click	MD9022	250W	L	●	●
21	Clipsal	32E450UDM	450W	U	●	●
22	Clipsal	32E450LM	450W	L	●	●
23	Clipsal	32E450TM	450W	T	●	●
24	Clipsal	CLDM350TS	350W	T	●	●
25	Clipsal	31E2RUUDM	350W	U	●	●
26	Clipsal	32ELEDM	150W	T	●	●
27	Clipsal	ULTI U101DSN600	600W	L	●	●
28	Danlers	DQD6DMK-400W	400W	T	●	●
29	DIMEZE	DZ2G450DIAL	450W	T	●	●

NO.	MANUFACTURER	MODELS	MAX LOAD	TYPE	QR14	
					1Lamp	5 Lamps
30	DIMINTELL	DIMMAX 520 S	520W	U	●	●
31	Dynalite	DDLE801	100W per channel	T	●	●
32	Dynalite	DDMC802	460W per channel	L	●	●
33	DINUY	RE EL1 LE1	400W	U	●	●
34	Ecopac	EcoDim-Triac	60-400W	L	●	●
35	ELKO	316 GLED	316VA	U	●	●
36	ELKO	RS16 315 GLE	315VA	T	●	●
37	ELKO	RS16/630 GLE	20-630W	T	●	●
38	ELKO	420 GLE	420W	U	●	●
39	ELKO	EKO07090	14-200VA	T	●	●
40	Eitako	EUD61NPN230V	400W	U	●	●
41	Eitako	EUD61NPN-UC	400W	U	●	●
42	ETMAN	ETM31PV2	25-315W	U	●	●
43	ETMAN	ETM329P	4-400W	U	●	●
44	EHMANN	T55.20	7-350VA	T	●	●
45	EverFlourish	EFM700DB	50-300W	L	●	●
46	EverFlourish	EF700DC	20-300W	T	●	●
47	Feller	40200 R.L.C	200VA	U	●	●
48	Feller	40300 R.C	20-300VA	T	●	●
49	Feller	40600 R.L.C	20-600VA	U	●	●
50	Finder	15.21.8.230.0200	200VA	U	●	●
51	GEWISS	GW 20 803	100-900W	L	●	●
52	GEWISS	GW 20 815	500W	L	●	●
53	Gira	1176-00/01	50-420W	T	●	●
54	Gira	5401 00	20-420W	U	●	●
55	Hager	EVN 011	300W	T	●	●
56	Hager	EVN 012	300W	T	●	●
57	Hamilton	HGDM250W	250W	T	●	●
59	Hamilton	LEDITB100	100W	T	●	●
60	Hamilton	LITESTAT	400W	L	●	Min 2 pcs
61	Hilux	To-Dim-LED 500	500W	U	●	●
62	Jung	225 TDE	20-525W	T	●	●
63	Jung	1730DD	20-200W	T	●	●
64	Jung	243EX	10-315W	T	●	●
65	Jung	244 HEX	20-500W	L	●	●
66	Kopp	8002	20-325W	T	●	●
67	Kopp	8085	40-400W	L	●	●
68	Kopp	8033	40-400W	L	●	●
69	Knightbridge	VFR200M	200VA	T	●	●
70	Knightbridge	VFR200I	200VA	T	●	●
71	Knightbridge	CU2161	400W	L	●	●
72	Legrand	Mosaic 78401	400W	U	●	●
73	Legrand	Mallia 281080	50-600W	L	●	●
74	Legrand	ASW3500005	500W	L	●	Min 2 pcs
75	Legrand	Celiane 67083	3-400W	U	●	●
76	Legrand	Celiane 67084	400W	U	●	●
77	Lutron	Rania RISU-452	50-450W	U	●	●
78	Lutron	Rania RISU-252	50-250W X2	U	●	●
79	LAP	VKDM400E	400W	L	●	●
80	LK	506DA219	120VA	T	●	●
81	LK	FUGA 506DA127	4-250VA	T	●	●
82	LK	820B1250	2x200VA	T	●	●
83	MK	K4501	40-220W	L	●	●
84	MK	K1501LV	500W	L	●	●
85	MK	K1523 WHILV	40-300W	T	●	●
86	Merten	MEG5134-0000	4-400W	U	●	●
87	Merten	MEG5136-0000	20-315W	T	●	●
88	Merten	MEG5138-0000	20-420W	U	●	●

NO.	MANUFACTURER	MODELS	MAX LOAD	TYPE	QR14	
					1Lamp	5 Lamps
89	Merten	MEG5139-0000	20-600W	U	●	●
90	MAXCOMFORT	ADAM2	10-200VA	T	●	●
91	NIKO	31001900	325W	U	●	●
92	NIKO	310-0280X	2-100W	T	●	●
93	Panasonic	WEJ57515	500W	L	●	●
94	Philips	UID8760	2-100VA	T	●	●
95	RAKO	RTM500	500W	T	●	●
96	Relco	NISKO NS1-40611	600W	L	●	●
97	Relco	RM0545	4-100VA	T	●	●
98	Rev	PrimaLuxe 0511442992	300W	L	●	●
99	Rev	DWS700DB	50-300W	L	●	●
100	Rev	ET1 66012B	20-300W	T	●	●
101	Robus	RLA200DT01	350W	T	●	●
102	Robus	RLA250DTG-01	350W	T	●	●
103	Shuttle	SDIMTLED125W	125W	T	●	●
104	Spazio	SPL TRIDIM 842	10-300W	T	●	●
105	Spazio	SPL UNIDIM 201	5-400W	T	●	●
106	Schneider	SBD200LED	4-400VA	T	●	●
107	Schneider	WDE002311	315W	T	●	●
108	Schneider	WDE002299	400W	U	●	●
109	Schneider	E8331RD250_WE	50-250VA	U	●	●
110	Schneider	E3031HD	600W	L	●	*
111	Schneider	GUGEMRDIM SS16	60-300W	L	●	*
112	Schneider	Pieno E8232RD500	450W	T	●	●
113	SAL	SDA450	450W	T	●	●
114	SAL	SDD400U	2-400W	U	●	●
115	SAL	SDD350T	350W	T	●	●
116	SAL	SDD350UM	350W	U	●	●
117	SAL	SDD350TCM	350W	T	●	●
118	SG	LEDDIM 200	200VA	T	●	●
119	SG	LEDDIM SMART PUSH	200VA	T	●	●
120	Star Trading	39902	200VA	T	●	●
121	theben	DIMAX 542 plus S	250W	U	●	●
122	Tradim	2485H	3-150W	T	●	●
123	Tradim	2490HP	150W	T	●	●
124	Tradim	2494H	3-100W	T	●	●
125	Unitec	42074L	20-400W	L	●	●
126	Unitec	30815	3-100W	U	●	●
127	VADSBO	LD 220	1-200VA	T	●	●
128	VADSBO	VD220	0-200VA	T	●	●
129	VADSBO	VD300	300VA	T	●	●
130	VADSBO	DU 250	1-250W	U	●	●
131	VARILIGHT	HQ1W	400W	L	●	●
132	VARILIGHT	HQ3W	400W	L	●	●
133	VARILIGHT	JQP401W	400W	T	●	●
134	VARILIGHT	VPro Z11400M	300W	T	●	●
135	VERMER	VE773400	150W	U	●	●
136	Vimar	20148	500W	L	●	●
137	Vimar	20160	40-500W	T	●	●
138	Yokis	MTV500E	500VA	U	●	●
139	Yokis	MTV500M	500VA	U	●	●
140	Zano	ZGRID500	500W	T	●	●
141	Zano	ZMO150	150W	T	●	●

* Can't be completely turned off

QR18 LED DIMMER COMPATIBILITY



NO.	MANUFACTURER	MODELS	MAX LAMPADINE /MAX BULBS
1	AROITIS.PA	E488I 37	2
2	AURORA	EN-DSP400X	5
3	AURORA	AU-DSP400X	5
4	ALED	EasyDimmer 200	4
s	ALED	EasyDimmer S00	4
6	BtIcIno	MATIX AMS702	5
7	BrItIsh Generai	OM400AP	4
8	Chck	CMA 14S MD9022	4
9	Danlers	DQD6DMK•400W	4
10	ELKO	3 I 5GLE	4
11	finder	15.51	2
12	finder	15.91	2
13	hage.-	GCIOI7	3
14	hage..	GC35I7	3
15	Hamdton	74 I XLEDITBIOO	4
16	HamIItion	LITESTAT L400I2 VERO2	s
17	KnIghtbr*IIdge	VFR200M	4
18	Legrand	67083	3
19	LIVOLO	2H24462A2	3
20	LONON	NBS8T6	5
21	LK	506DA219	4
22	LK	FUGA LED2SOTOUCH	4
23	MK	5007409 1-00I	4
H	01*IIno	S70720 I	3
25	prime	NO.BRAS	s
26	RELCO	SNELLO LEDT3S	3
27	RELCO	RH SNELLOT3S	3
28	RELCO	RMOS40	3
29	RELCO	RTS34DLT	3
30	Rev	ETI 660I2B	5
31	SAL	SDD400U	4
32	TECNEL	FLO7636M	3
33	rECNEL	TE4489SB	2
34	rRANCIL	D.m.L/3B	3
35	theben	DIMAX 544PLUS	5
36	Uni tee	308 I 5	5
37	V-COM	1601260-2	3
38	VFR200M	TrallongEdge 2WAY-PUSH	3
39	VIKO	804040	5
40	VARILIGHT	JQP40IW	4
41	Yokis	MTVS00E	4
42	Zano	ZM0250	2

Indice alfabetico

Alphabetical index

<p>A 206 A+B SOFFITTO 194 A+B SOSPENSIONE 226 ALTAIR 176 AQUA_EVO</p> <p>B 162 BELLATRIX 266 BLOC_EVO 78 BOMBO 232 BOX</p> <p>C 330 COMBI EVO 236 CONTAINER 224 CYL SOFFITTO 202 CYL SOSP</p> <p>D 332 DARDO 122 DEEP_EVO 114 DEEP_EVO EXTR. 128 DEEP_EVO GRANDE 130 DEEP_EVO_Q 131 DEEP_EVO_Q GRANDE 131 DEEP_EVO STD 134 DEEP_EVO GU10 136 DEEP_EVO AR111 GU10 298 DIOGENE 108 DOT 282 DOUBLE 340 DRIVER E ACCESSORI 268 DUMBO</p> <p>E 105 EMERGENZA TRACK 260 ESSENTIAL</p> <p>F 326 FOS 182 FRAME 183 FRAME 111 185 FRAMELESS 186 FRAMELESS 111 64 FULGOR TRACK 160 FULGOR_IN 210 FULGOR SOFFITTO/PARETE</p>	<p>I 94 INVISIBILE 304 IOTA</p> <p>K 34 KLIK_KLAK 216 KLIK_KLAK PUNTIFORME SOFFITTO 44 KLIK KLAK MINI 54 KLIK KLAK MICRO</p> <p>L 140 LIGHT_35 144 LIGHT_50 150 LIGHT_111 10 LINEAR SYSTEM 280 LINE DEEP 281 LINE 276 LINE_EVO 279 LINE_MINI 159 LUMIS_Q 223 LUMIS_Q SOFFITTO 158 LUMIS_T 222 LUMIS_T SOFFITTO</p> <p>M 172 MINI 254 MINIMA 132 MODULI LED DEEP_EVO 148 MODULI LED+ADATTATORE FOR LIGHT_50 322 MOONLIGHT</p> <p>O 171 OCCHIO 275 ONDA</p> <p>P 283 PR1 283 PR1_DEEP 284 PR2 284 PR2_DEEP 285 PR3_EVO 166 PUNTO</p> <p>S 336 SKORPIO 198 SHANGHAI 314 SLICE</p>	<p>S 90 SOSPENSIONI TRACK 96 STREAMLIGHT TRACK 22 STREAMLIGHT INCASSO 16 STREAMLIGHT SYSTEM 264 SU&GIÙ 84 SUN_111 TRACK 212 SUN_111 SOFFITTO/PARETE</p> <p>T 316 TITANO_EVO 248 TORCIA_O 242 TORCIA_V 100 TRACKS 292 TWIGGY_LESS</p> <p>U 88 UNICO TRACK 214 UNICO DICRO SOFFITTO/ PARETE</p> <p>W 274 WALL 188 WIZARD</p> <p>Z 308 ZEN 175 ZEUS</p>
--	--	---

Logica è un marchio di Marino Cristal S.p.A.

Marino Cristal S.p.A.

Via Guardia del Consiglio, 31
47899 Serravalle
Rep. di San Marino

Tel. (+378) 0549 901188
Fax (+378) 0549 900612

www.logicailuminazione.com
info@logicailuminazione.com

Progetto grafico
Studio JAM

Stampa
Pazzini Stampatore Editore